

EN Accessories Manual

CS Manuál k příslušenství

DA Tilbehørsmanual

DE Zubehörhandbuch

ES Manual de accesorios

FR Manuel des accessoires

IT Manuale Accessori

NL Handleiding accessoires

NO Håndbok for tilbehør

PL Instrukcja dot. akcesoriów

PT Manual de acessórios

SV Tillbehörshandbok

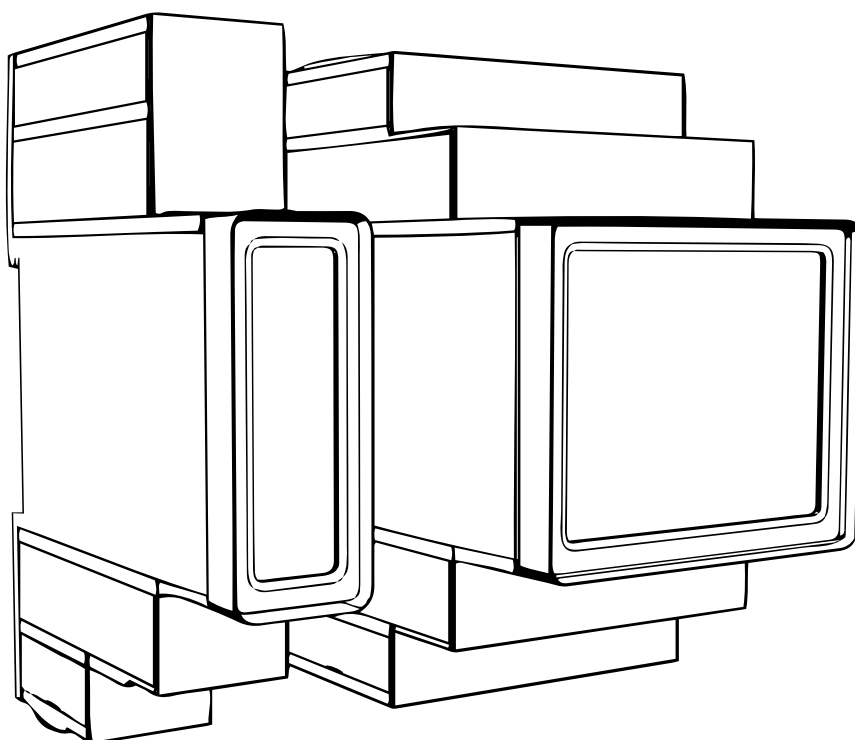

 **LuxWallbox**

Accessories Manual



For safe and proper use,
follow these instructions.
Keep them for future reference

Rev.01 - 09/2024
PKM.000004

EN

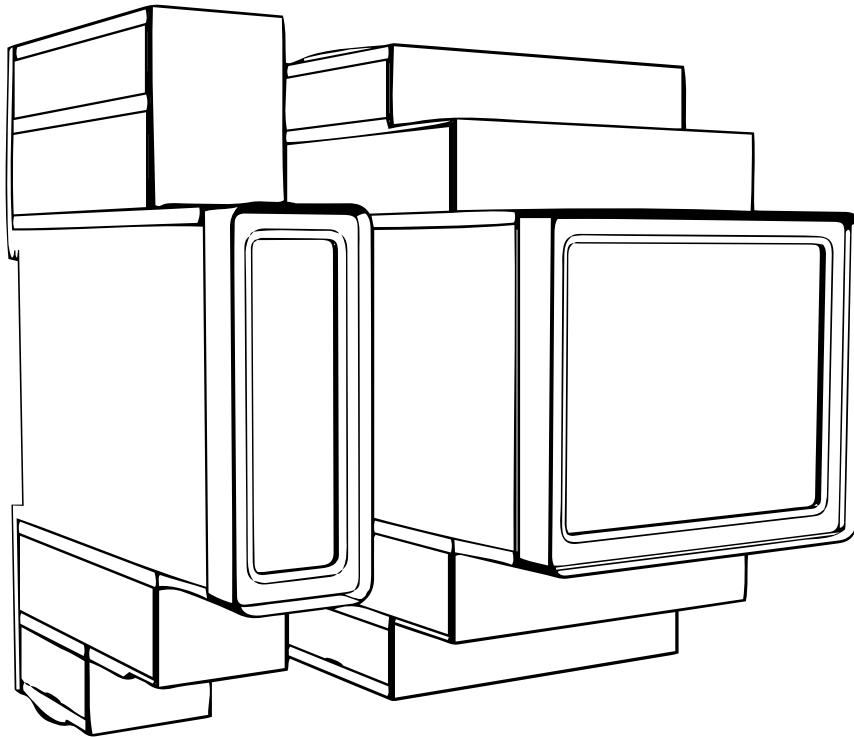
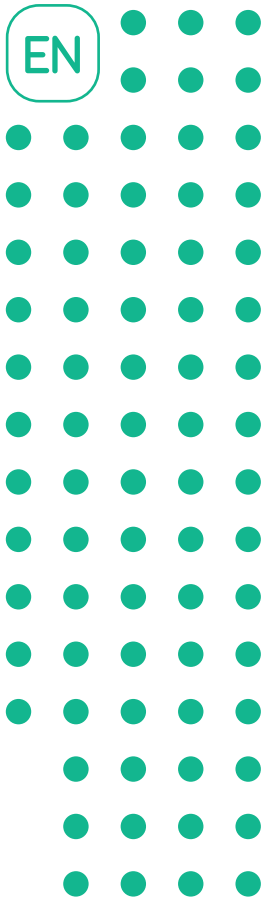

LuxWallbox

Accessories Manual



For safe and proper use,
follow these instructions.
Keep them for future reference

Table of content

1. INTRODUCTION	4
1.1. Purpose of the Manual	4
1.2. Identification of the Manufacturer.....	4
1.3. Structure of the Accessories Manual	4
1.4. Safety	5
1.5. Personal Protective Equipment (PPE).....	6
1.6. Warranty and delivery conditions	6
1.7. List of documents.....	7
1.8. Warnings	7
2. GENERAL INFORMATION	8
2.1. Fields of use	9
3. ACCESSORIES INSTALLATION	10
3.1. Installing PowerMeter (DPM).....	10
3.2. Installing MIDcounter	15
3.3. Communication cable installation	17
3.4. MIDcounter and PowerMeter (DPM) combined installation .	19
4. PowerMeter (DPM) and MIDcounter configuration.	22
4.1. Finder models.....	22
4.2. Gavazzi models.....	24
4.3. Device configuration summary	25
4.4. PowerMeter (DPM) and MIDcounter configuration on APP ..	26
4.5. PowerMeter (DPM) configuration	28
4.6. MIDcounter configuration.....	30
5. TROUBLESHOOTING.....	31
6. CLEANING.....	36
7. PACKAGING DISPOSAL	36
8. ASSISTANCE.....	37
9. DISCLAIMER.....	37



1. INTRODUCTION

1.1. Purpose of the Manual

This installation manual is a guide to help operators to work safely and carry out the installation operations needed to keep the charger in good working order.

The purpose of this document is to support qualified technicians who have received appropriate training, and demonstrated suitable skills and knowledge in the construction, installation, operation and maintenance of electrical equipment.

If the charger is used in a manner not specified in this manual, the protection provided by the charger may be impaired. This document contains the information required for the installation of the charger.

This document has been carefully checked by the Manufacturer Free2move eSolutions S.p.A. but oversights cannot be completely ruled out. If any errors are noted, please inform Free2move eSolutions S.p.A. Except for explicit contractual obligations, under no circumstances may Free2move eSolutions S.p.A. be held liable for any loss or damage resulting from the use of this manual, or from installation of the equipment. This document was originally written in English. In the event of any inconsistencies or doubts, please ask Free2move eSolutions S.p.A. for the original document.

1.2. Identification of the Manufacturer

The manufacturer of the charger is:

Free2move eSolutions S.p.A.

Piazzale Lodi, 3

20137 Milan – Italy

www.esolutions.free2move.com

1.3. Structure of the Accessories Manual

This manual is divided into chapters based on different topics and containing all the information that is needed to install the charger safely.

Each chapter is sub-divided into paragraphs which examine the fundamental points, and each paragraph may have its own title, along with sub-titles and a description.

1.4. Safety

This manual contains important safety instructions that must be followed during installation of the charger.

In order to fulfil this objective, this manual contains a number of precautionary texts, containing special instructions. These instructions are highlighted by a specific text box and are accompanied by a symbol, and are provided in order to ensure the safety of the personnel required to perform the operations described, and to avoid any damage to the charger and/or property:

	<p>This symbol means: DANGER</p> <p>This symbol is intended to highlight a dangerous situation for yourself and others. Read it carefully. Failure to comply with the instruction will result in an imminent hazardous situation which, if not avoided, will result in instant death, or serious or permanent injury.</p>
---	--

	<p>This symbol means: WARNING</p> <p>This symbol is intended to highlight safety information. Failure to comply with the instruction will result in a potentially hazardous situation which, if not avoided, could result in death or serious injury.</p>
---	--

	<p>This symbol means: CAUTION</p> <p>This symbol is intended to highlight safety information. Read it carefully. Failure to follow these instructions can result in death, serious injury or damage to equipment.</p>
---	--

	<p>This symbol means: NOTE</p> <p>Provides additional information to supplement instructions provided.</p>
---	---

	<p>This symbol means: NOTICE</p> <p>Provides instructions concerning the use of conduct necessary to handle the operations not associated with possible physical injuries.</p>
---	---

Installation must be carried out by qualified personnel. A dedicated, state-of-the-art electricity supply system must be designed and installed, and the system must be certified in compliance with local regulations and the energy supply contract.

Operators are required to read and fully understand this manual, and to comply strictly with the instructions it contains.

Free2move eSolutions S.p.A. cannot be held liable for damage caused to persons and/ or property, or to the equipment, if the conditions described in this document have not been complied with.





WARNING: Installation must be carried out in accordance with the regulations in force in the country of installation, and in compliance with all safety regulations for carrying out electrical work.

1.5. Personal Protective Equipment (PPE)

Personal Protective Equipment (PPE) means any equipment intended to be worn by the workers in order to protect them against one or more hazards likely to threaten their health or safety at the workplace, as well as any device or accessory intended for this purpose.

Since all the PPE indicated in this manual is intended to protect the personnel against health and safety hazards, the Manufacturer of the charger which is the subject of this manual recommends strict compliance with the indications contained in the various sections of this manual.

The list of PPE to be used in order to protect the operators against the residual risks present during the installation and maintenance interventions described in this document is provided below.

Symbol	Meaning
	Wear protective gloves
	Wear anti-static footwear



WARNING: It is responsibility of the operator to read and understand local regulations and evaluate the environmental conditions of the installation site in order to comply the need to wear additional PPE.

1.6. Warranty and delivery conditions

The warranty details are described in the Terms and Conditions of Sale included with the purchase order for this product and/or in the packaging of the product.

Free2move eSolutions S.p.A. assumes no responsibility for failure to comply with the instructions for proper installation, and cannot be held responsible for systems upstream or downstream of the equipment supplied.

Free2move eSolutions S.p.A. cannot be held responsible for defects or malfunctions deriving from: improper use of the charger; deterioration due to transport or particular environmental conditions or installation by unqualified persons.

Free2move eSolutions S.p.A. is not responsible for any disposal of the equipment, or parts thereof, that does not comply with the regulations and laws in force in the country of installation.



NOTICE: Any modification, manipulation or alteration of the hardware or software not expressly agreed with the manufacturer will immediately void the warranty.

1.7. List of documents

In addition to this manual, product documentation can be viewed and downloaded by visiting: www.esolutions.free2move.com.

1.8. Warnings



DANGER: Risk of electric shock and fire. Installation must be carried out in accordance with the regulations in force in the country of installation, and in compliance with all safety regulations for carrying out electrical work.

- Before installing or using the device, make sure that none of the components have been damaged. Damaged components can lead to electrocution, short circuits, and fire due to overheating. A device with damage or defects must not be used.
- Install **eLuxWallbox** away from petrol cans or combustible substances in general.
- Before installing **eLuxWallbox compatible accessories**, ensure the main power source has been disconnected.
- The **eLuxWallbox compatible accessories** must only be used for the specific applications they are designed for.
- Installation not carried out correctly may pose risks to the user.
- The charger must be connected to a mains network in compliance with local and international standards, and all the technical requirements indicated in this manual.
- Children or other persons not able to gauge risks related to the installation of the charger could suffer serious injury or put their lives at risk.
- Pets or other animals must be kept away from the device and packaging material
- Children must not play with the device, accessories or packaging provided with the product.
- The only part that can be removed from **eLuxWallbox**, is the removable cover. Access under the cover is only permitted by qualified personnel during installation, dismantling or maintenance.
- **eLuxWallbox** can only be used with an energy source.
- Necessary precautions to ensure safe operation with Active Implantable Medical Devices must be taken. To determine whether the charging process could adversely affect the medical device, please contact its manufacturer.

2. GENERAL INFORMATION

eLuxWallbox is an Alternate Current charging solution for powering electric vehicles and hybrid plug-ins, and is ideal for semi-public and residential use. The charger is available in three-phase or single-phase configurations and is equipped with a Type 2 socket.

The charger charges electric vehicles up to 22 kW in three-phase, or up to 7.4 kW in single-phase. The charger includes connectivity options such as remote monitoring via the eSolutions control platform (CPMS). Its final configuration must be completed using the **PowerUp** application. For the end user, the **eLuxWallbox** can be managed via the dedicated user's eSolutions Charging App. Both applications are available on Google Play™ and Apple Store®.

This charger is equipped with a SIM card for connection to the 4G mobile network.

The SIM card is automatically activated the first time the charger is turned on.

This document describes how to install the external accessories compatible with the **eLuxWallbox**.

The external accessories described in this manual are:

- **PowerMeter (DPM)**: an energy meter that enables the Dynamic Power Management (**DPM**) which is a smart function that allows an electric vehicle to be recharged using only the power available at home, modulating the charging power and avoiding unpleasant blackouts.
- **MIDcounter**: a certified energy meter that allows to monitor the consumption of the **eLuxWallbox** during each charging session.

This manual contains a description of the characteristics of the different accessories, information on models, installation process and final configuration of the devices.

The **eLuxWallbox** is configured to be used with the following electrical accessories: **PowerMeter (DPM)** or **MIDcounter**:

- Gavazzi, 1-phase, Direct, 32 A
- Finder, 1-phase, Direct, 40 A
- Gavazzi, 3-phase, Direct, 65 A
- Finder, 3-phase, Direct, 80 A

PowerMeter (DPM):

- Gavazzi, 1-phase, Indirect with 1x CT 100 A
- Gavazzi, 1-phase, Indirect with 1x CTV 60 A
- Gavazzi, 3-phase, Indirect with 3x CT 150 A



WARNING: Do not try to install the Electrical Accessories if you are not qualified as a professional electrician. To do so could cause serious danger and harm to you and to the people, property or animals around you.

To complete the installation, it is necessary to configure the **eLuxWallbox** through the dedicated apps:

	Installer's app: PowerUp
Product versions (EU):	EPRO23S224GWBAX
Product versions (UK):	EPRO23S224GWBAS



WARNING: Only Electrical Accessories suggested by Free2move eSolutions S.p.A. are compatible. Installation must be performed by qualified personnel in accordance with local regulations.

2.1. Fields of use

Free2move eSolutions S.p.A. declines all liability for any damage whatsoever due to incorrect or careless actions.

The charger may not be used for any purpose other than the one it is intended to fulfill.

The equipment must not be used by children or people with limited mental or physical abilities, or even by adults or expert professionals if the charger undergoes operations that do not comply with this manual and accompanying documentation.

The charger is a charging device for electric vehicles; the following classification (according to IEC 61851-1) identifies its characteristics:

- Power supply: permanently connected to the AC power supply grid
- Output: Alternate Current
- Environmental conditions: indoor / outdoor use
- Fixed installation
- Protection against electric shock: Class I
- EMC Environment classification: Class B
- Charging type: Mode 3 according to the IEC 61851-1 standard
- Optional function for ventilation not supported

3. ACCESSORIES INSTALLATION

To install the electrical accessories, it is necessary to use Modbus communication cables with the following characteristics:

- Modbus RS485 twisted STP 2x2 AWG24 or S/FTP cat.7 suitable for installation with a 400V power line
- Conductor size: 0.5 mm²
- Stripping length: 10 mm
- Recommended maximum length: 150 m

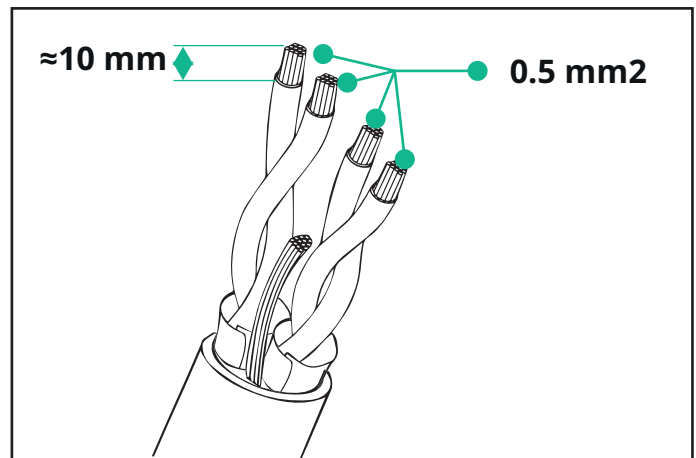

3.1. Installing PowerMeter (DPM)

PowerMeter (DPM) is an energy meter that enables the Dynamic Power Management (**DPM**) which is a smart function that allows an electric vehicle to be recharged using only the power available at home, modulating the charging power and avoiding unpleasant blackouts. Whenever other appliances are being used during the charging session, the system can modulate the charging power towards the car, even temporarily suspending the charging session. As soon as the other domestic appliances are switched off, the session will resume.

The **DPM** smart logic works both in three-phase and in single-phase installations.



WARNING: When installing in three-phase systems, make sure that the electrical loads (including the wallbox) are well balanced between the phases of the electrical system.



WARNING: Before carrying out any installation or maintenance work on the device, it must be ensured that the power supply is switched off.

For Direct models of the PowerMeter (DPM):

Place the **PowerMeter (DPM)** after the main utility meter. The **PowerMeter (DPM)** must measure all the electrical loads, including the **eLuxWallbox**.

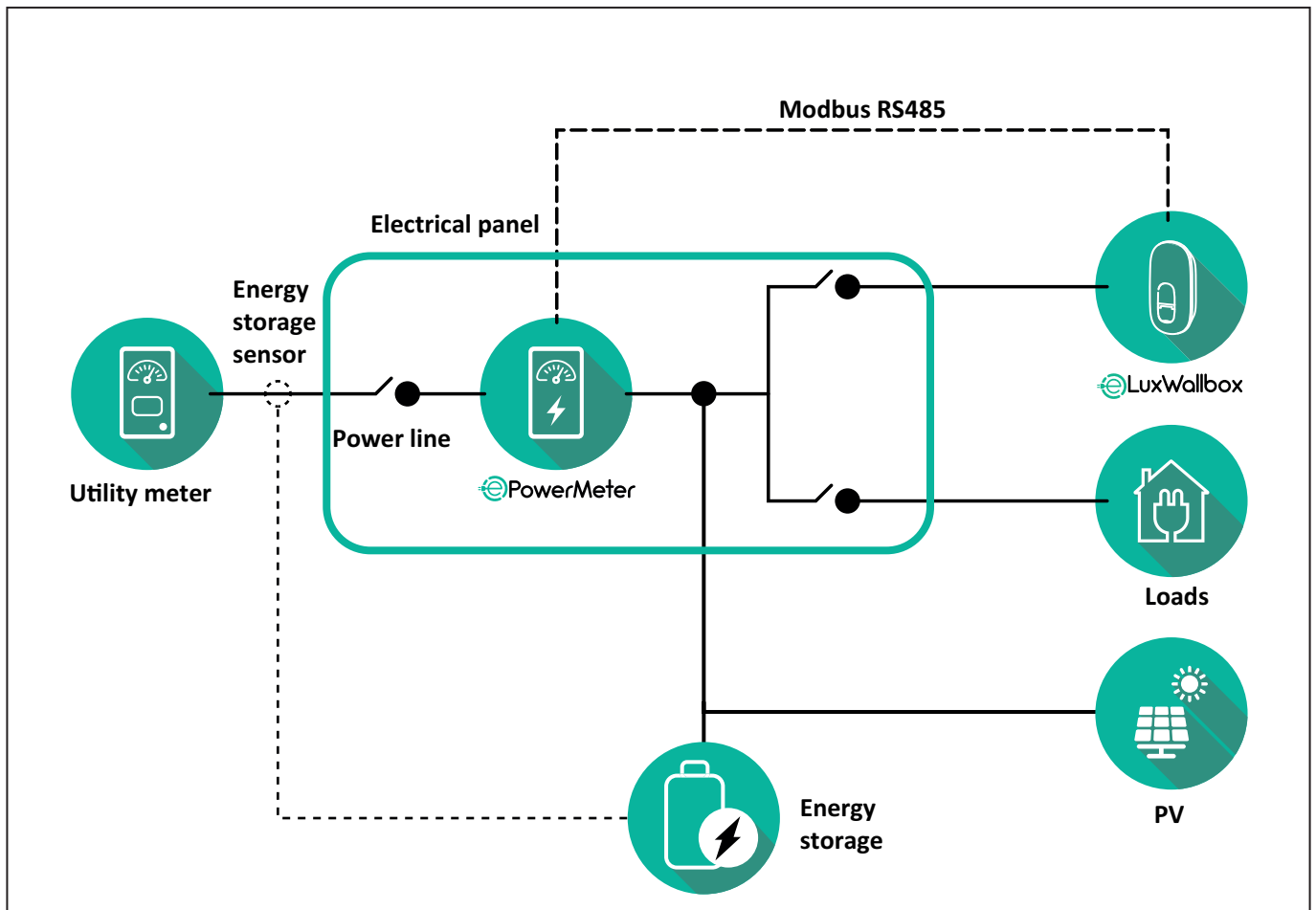

For Direct models of the PowerMeter:



WARNING: During the installation always refer to the manufacturer installation manual provided with the meter.



NOTE: For the single-phase or three-phase electrical connection of the Direct **PowerMeter**, please refer to the diagrams below.

Finder model 1ph and 3ph

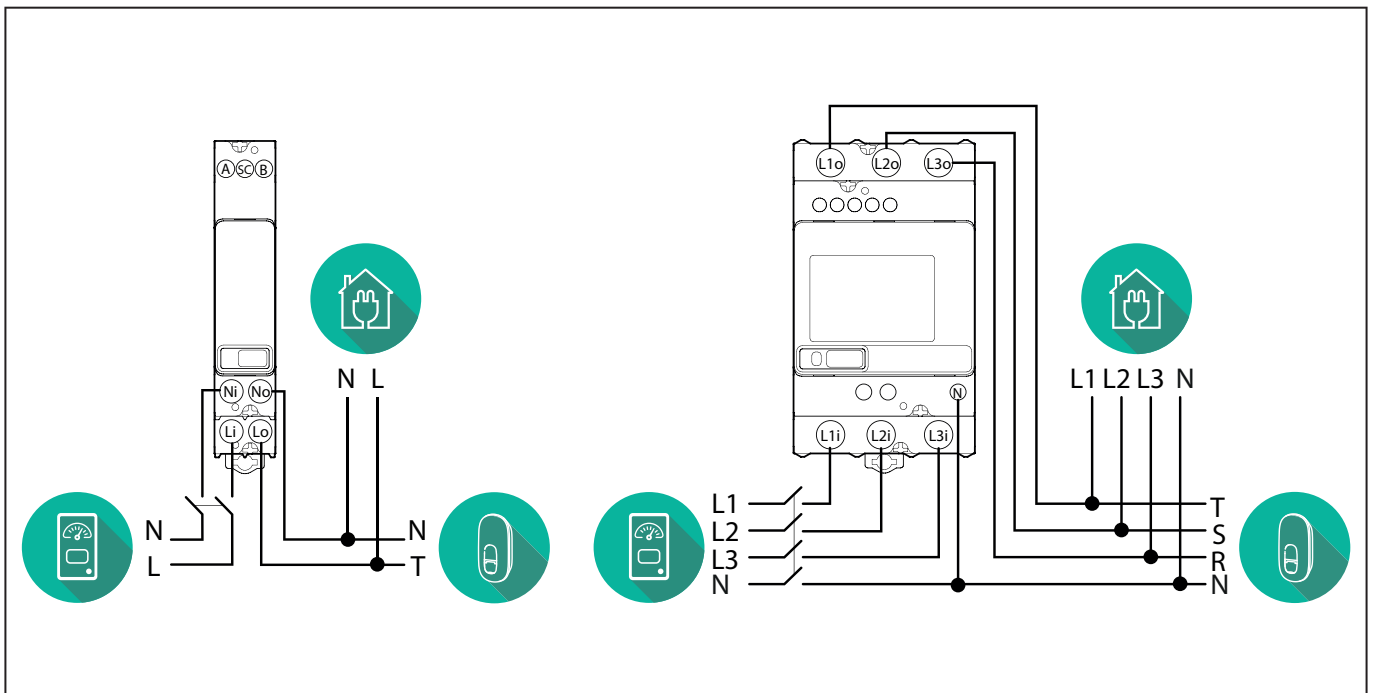

Gavazzi model 1ph and 3ph

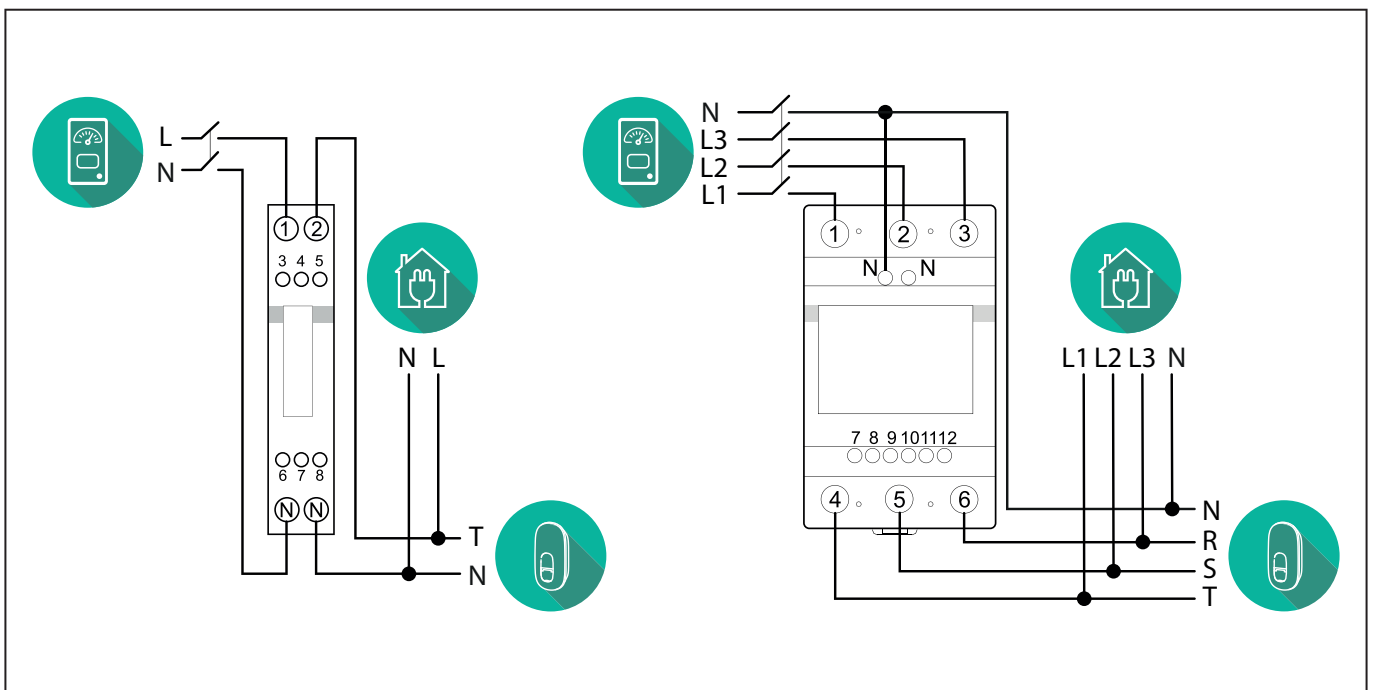

NOTICE:



- 1) If PV is present, the **PowerMeter** should be placed between the Utility Meter and the PV connection point.
- 2) If there is a home Energy storage, the **PowerMeter** should be placed between the Energy storage connection point and the Energy storage measurement sensor.

For Indirect models of the PowerMeter:

Place the CT (current transformer) of the **PowerMeter** after the main utility meter and before the main switch of the house/building. The current transformer must measure all the domestic loads, including the **eLuxWallbox**.

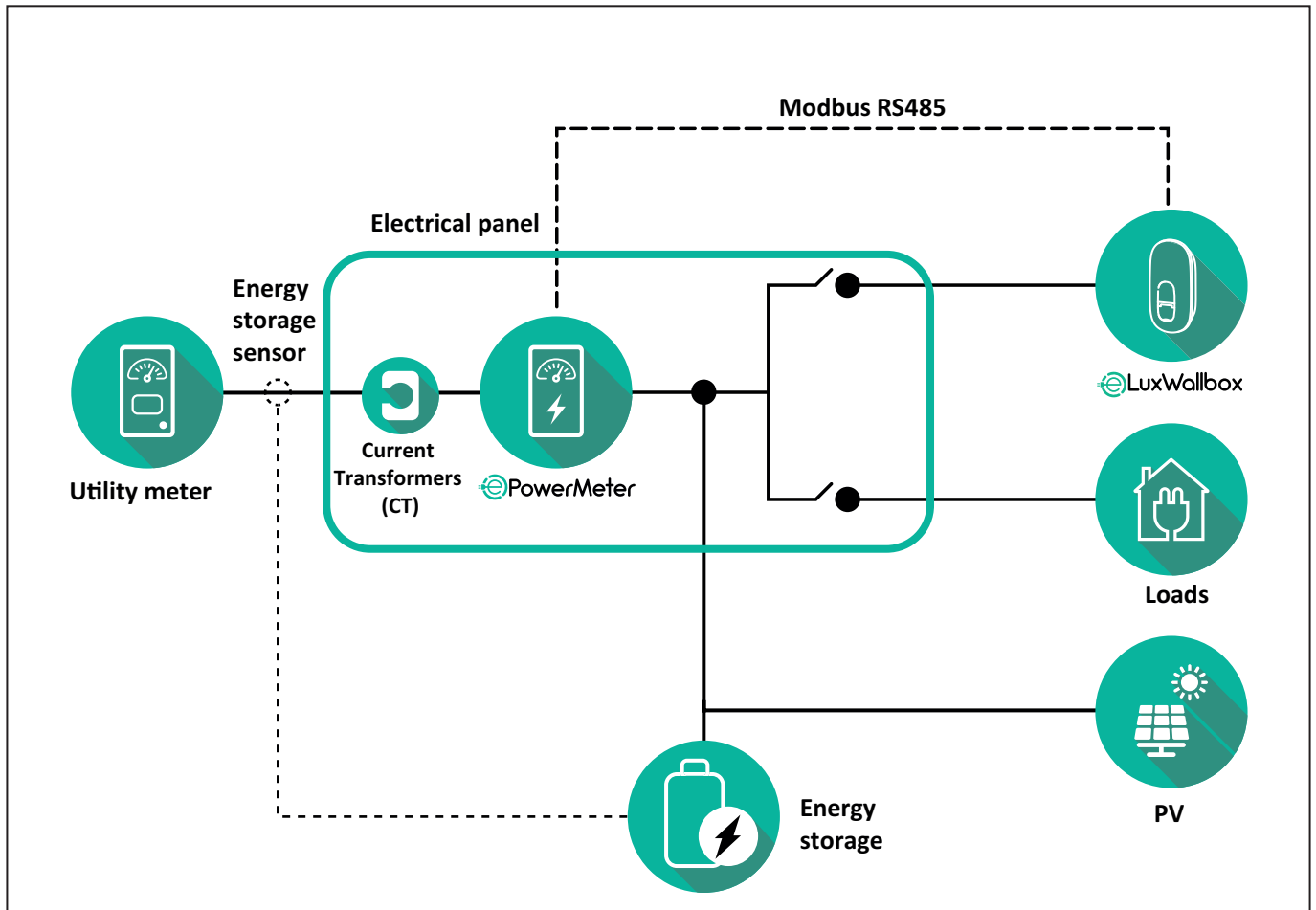

NOTICE:



1) If PV is present, the **PowerMeter** Current Transformers (CT) should be placed between the PV connection point and the Utility Meter.

2) If there is a home Energy storage, the **PowerMeter** Current Transformers (CT) should be placed between the Energy storage connection point and the Energy storage measurement sensor.

Connect the Current Transformers (CT) as indicated in the meter installation manual. Point the arrow on the CT in the direction of the loads.

For the three-phase or single-phase electrical connection of the indirect **PowerMeter**, refer to the diagrams below.

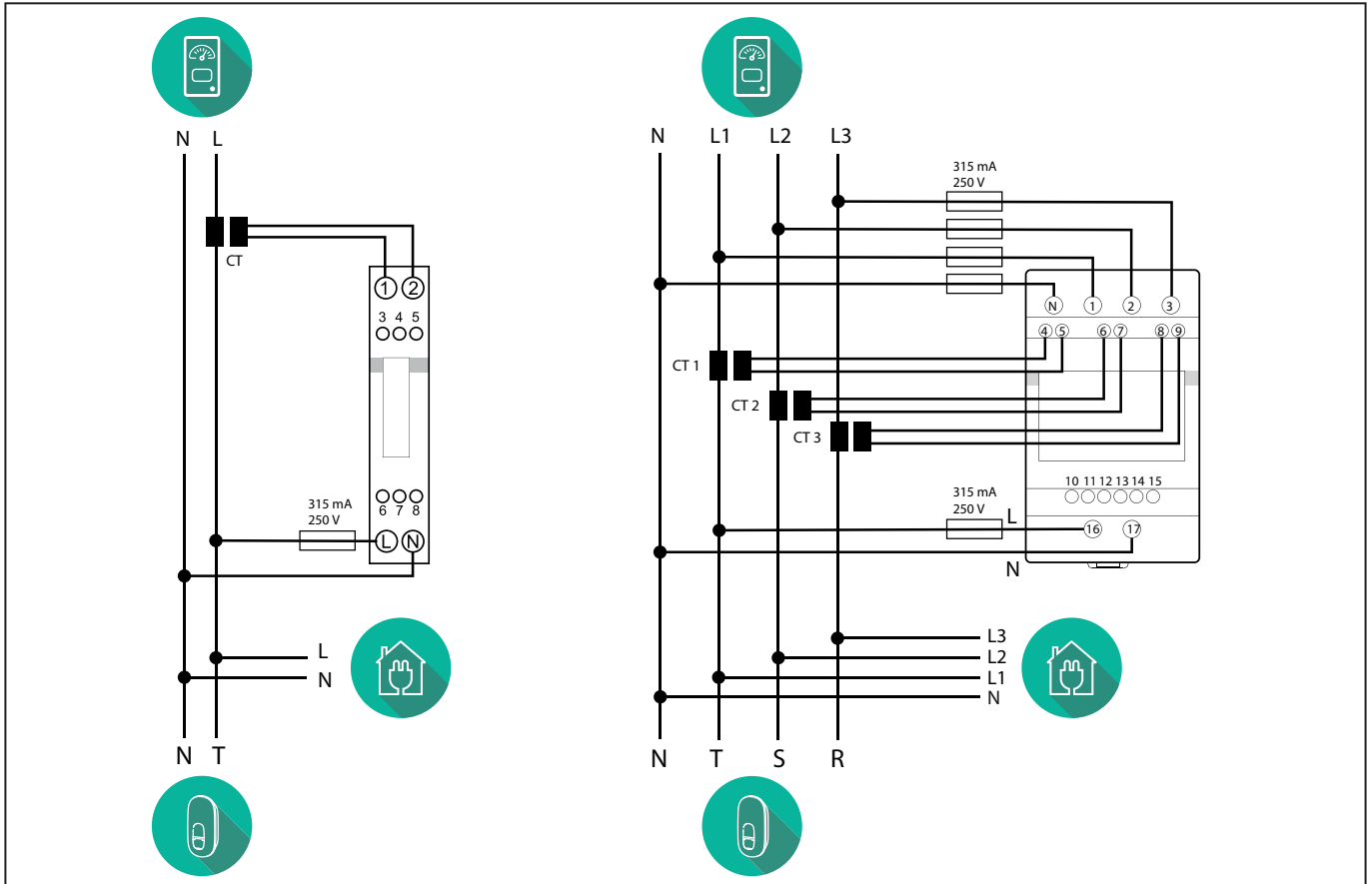

3.2. Installing MIDcounter

The **MIDcounter** is a certified energy meter that allows the consumption of the charger to be safely and reliably monitored during each charging session.

All the relevant data of the charging sessions is automatically recorded by a certified **MID** meter and transferred from the charger to the Charge Point Management System (CPMS).



WARNING: The power to the charger must remain off during this step.

Place the **MIDcounter** on the same power line as the charger, after the electrical protection devices.

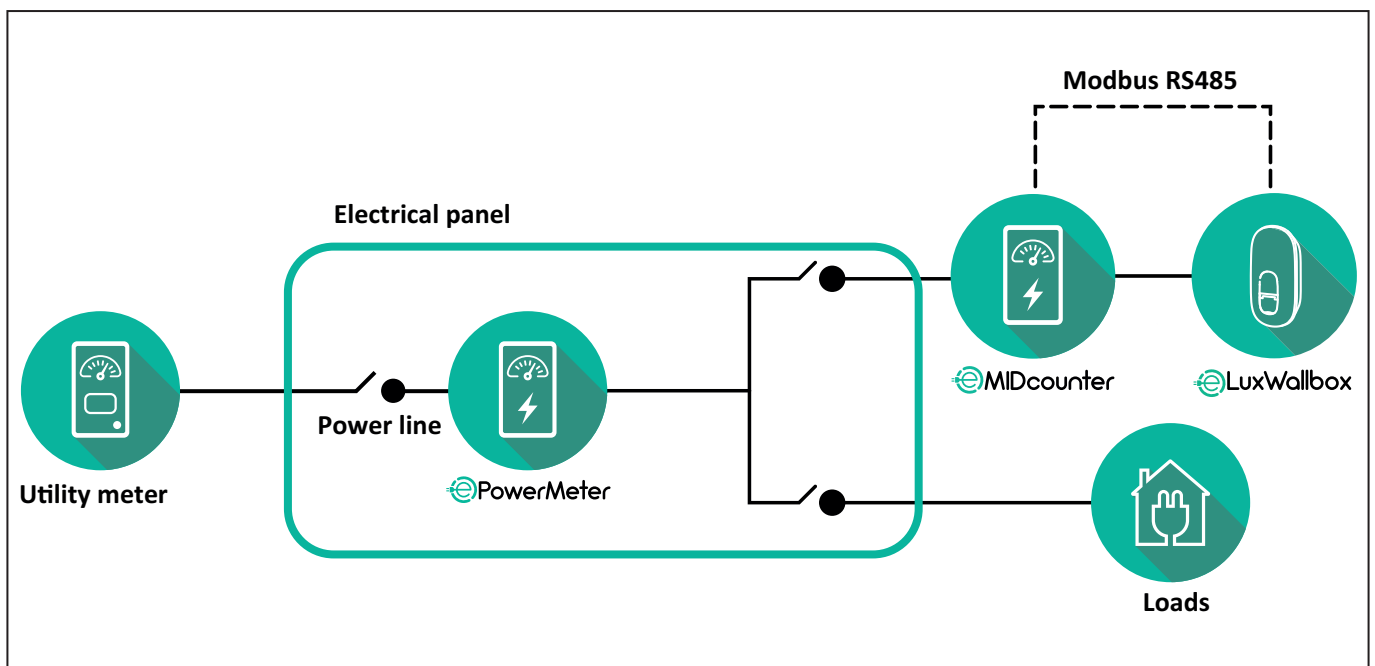

See the diagrams below for single phase and three phase electrical connection of **MIDcounter** (Finder and Gavazzi).

**Finder 1-phase, Direct, 40 A
(7M2482300210)**

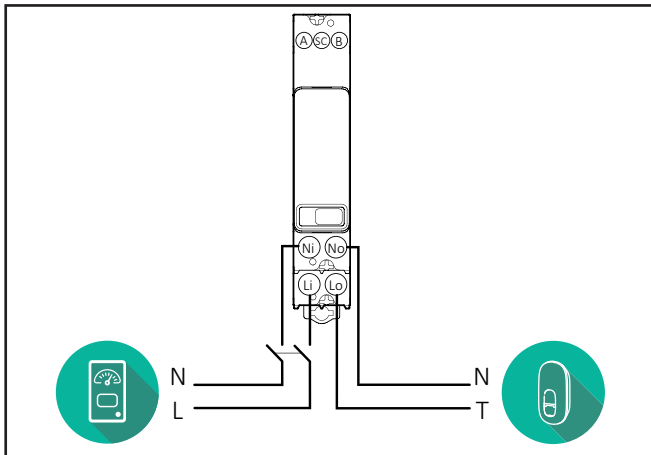

**Gavazzi, 3-phase, Direct, 65 A
(EM340DINAV23XS1PFB)**

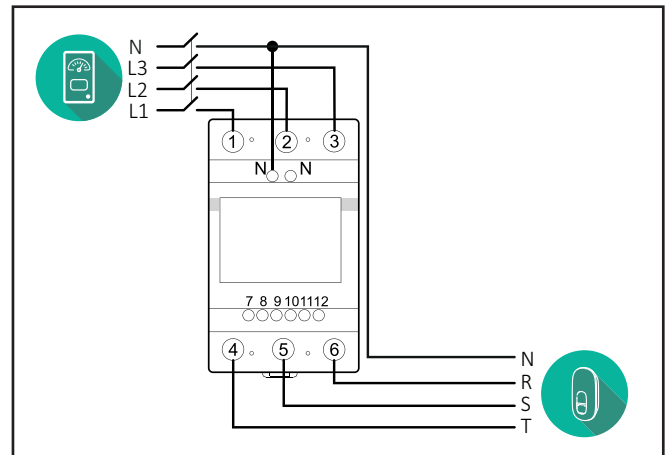

**Finder 3-phase, Direct, 80 A
(7M3884000212)**

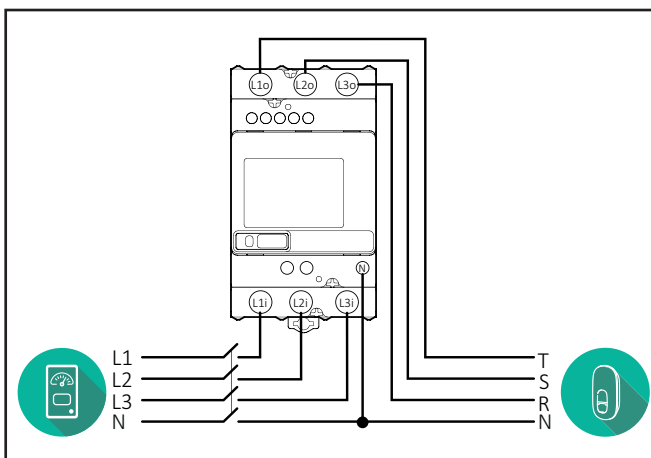

**Gavazzi, 1 phase, Direct, 100 A
(EM112DINAV01XS1PFB)**

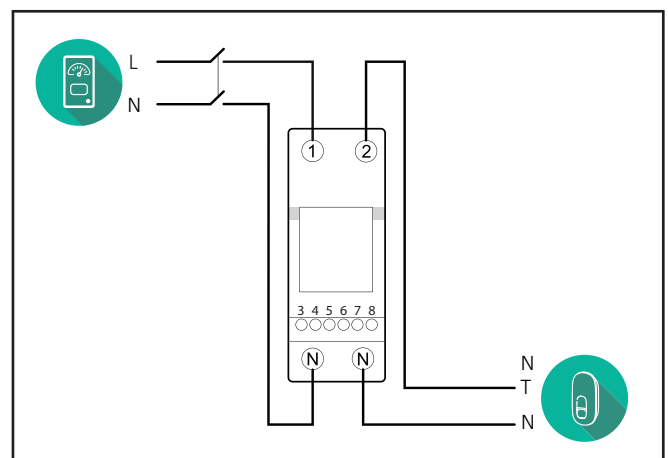

**Gavazzi, 1-phase, Direct, 32 A
(EM111DINAV81XS1PFB)**

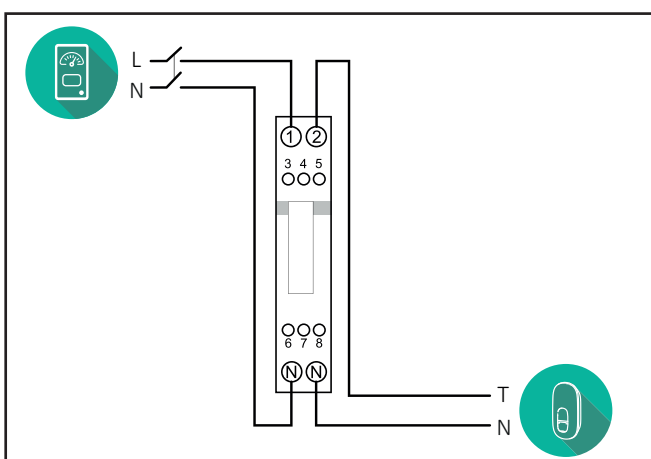

3.3. Communication cable installation

Install a communication cable between the **PowerMeter (DPM)** and the **eLuxWallbox**.

- On the **eLuxWallbox**, remove the protective cap of the communication cables entry point and insert the \varnothing 25 mm corrugated sheath.
- Tighten the box-cable sheath junction.
- Insert the communication cable, pulling it to a suitable length so that it reaches the communication port CN12, leaving some slack.
- Connect the Modbus RS485 communication cable to the GND, - and + pins of the CN12 connector.



NOTE: It is possible to replace the box-cable sheath junctions with \varnothing 25mm cable gland (not provided by the manufacturer).

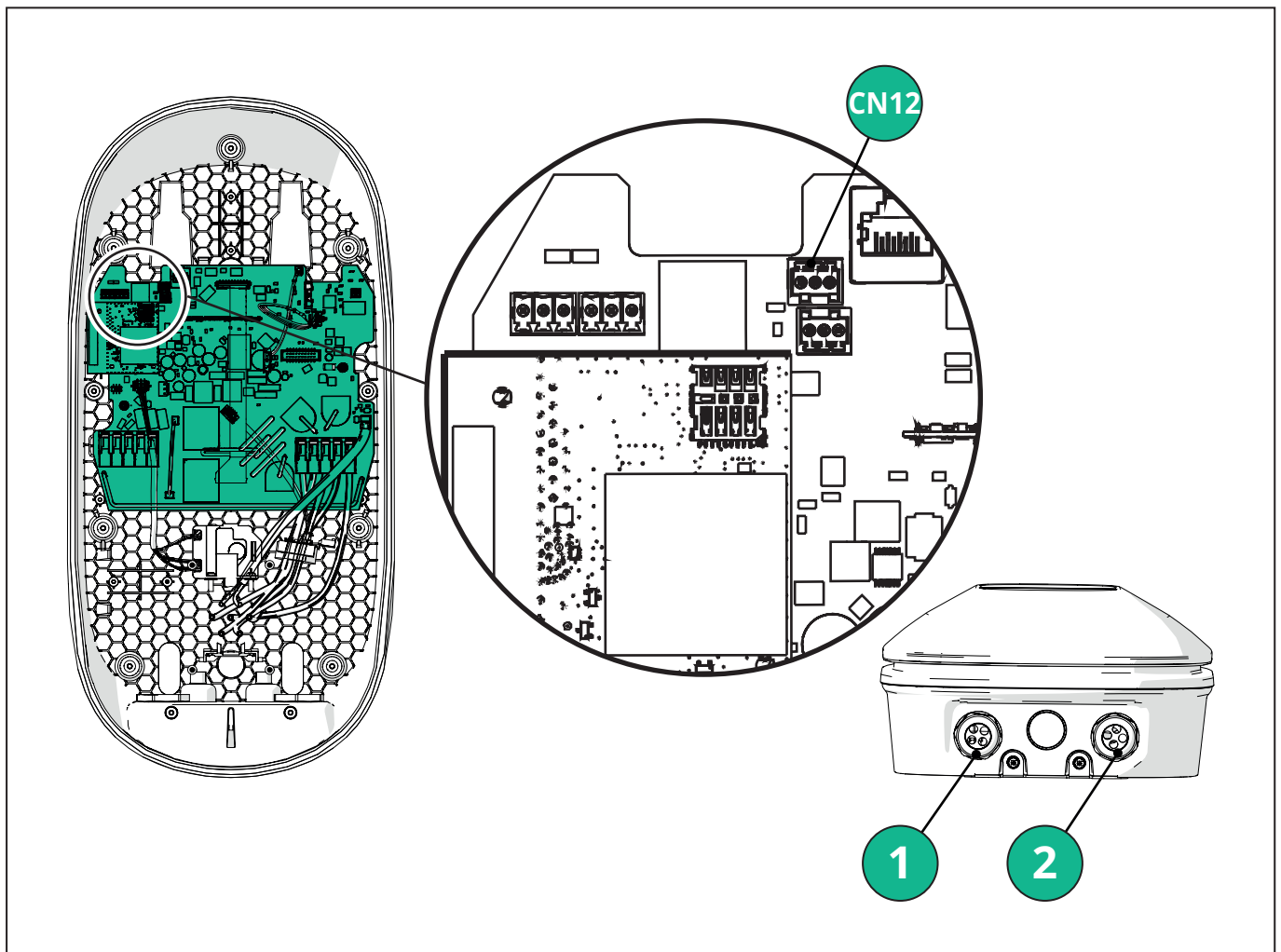

1 - Power supply cables

2 - Communication cables

CN12 - RS485 Modbus for external meter communication (**DPM** and **MID**)

Connect the communication cables in the following order from the **PowerMeter (DPM)** to **eLuxWallbox**.



WARNING: If the installation includes both accessories, follow the instructions for “MIDcounter and PowerMeter (DPM) combined installation”.

CN12	Finder 1ph 7M.24.8.230.0210
GND	SC
-	B
+	A

CN12	Gavazzi 3ph EM340DINAV23XS1PFB
GND	10
-	9
+	8

Junction 9/7

CN12	Finder 3ph 7M.38.8.400.0212
GND	SC
-	B
+	A

CN12	Gavazzi Ind 1ph EM111DINAV51XS1X / EM111DINMV51XS1X
GND	7
-	8
+	6

Junction 8/5

CN12	Gavazzi 1ph EM111DINAV81XS1PFB
GND	7
-	8
+	6

Junction 8/5

CN12	Gavazzi Ind 3ph EM330DINAV53HS1X
GND	13
-	12
+	11

Junction 12/10

3.4. MIDcounter and PowerMeter (DPM) combined installation

If installing both electrical accessories, the positioning of **MIDcounter** together with the **PowerMeter (DPM)** is indicated in the diagram below:

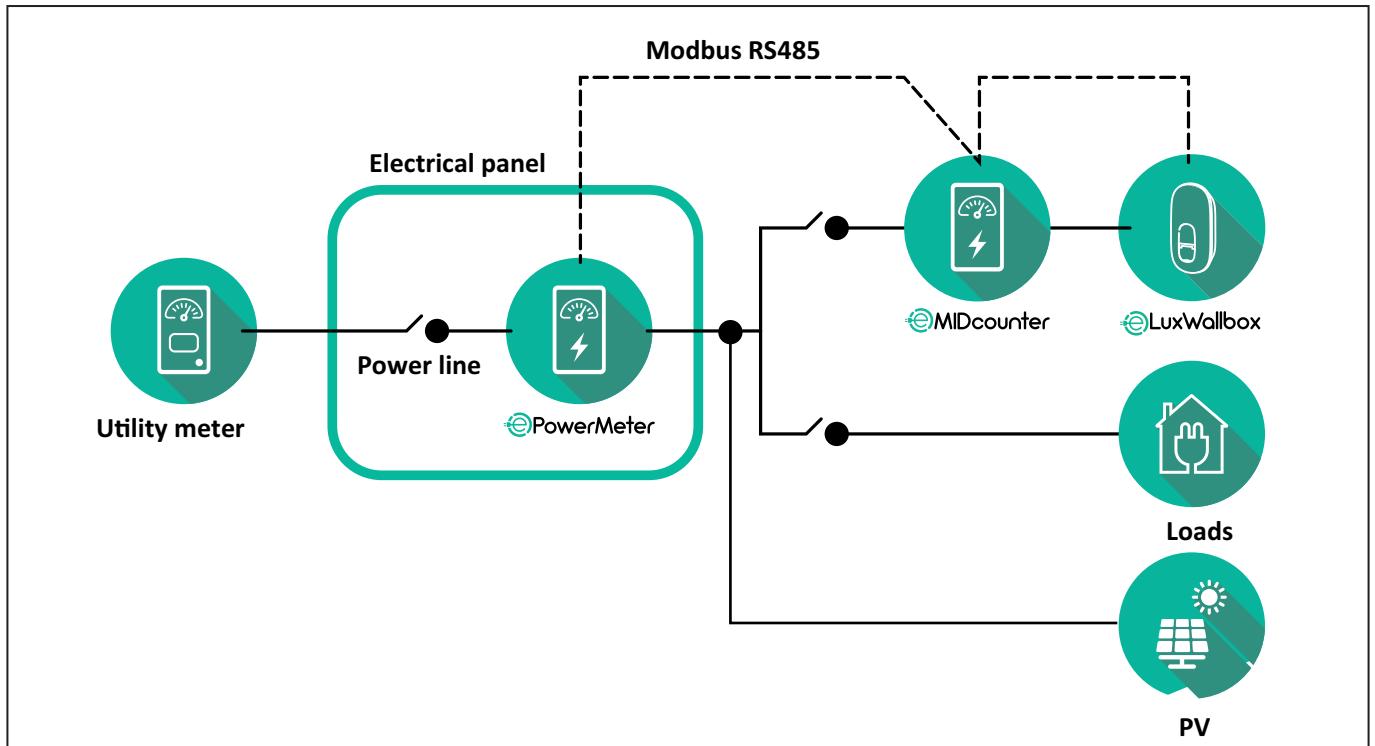

Connect the Modbus communication cables. The **PowerMeter (DPM)**, **MIDcounter** and the **eLuxWallbox** must be connected on the same communication bus in a Daisy chain format.

On the **eLuxWallbox**:

- Remove the protective cap of the communication cable entry point and insert the \varnothing 25 mm corrugated sheath.
- Tighten the box-cable sheath junction.
- Insert the communication cable, pulling it to a suitable length so that it reaches the communication port CN12, leaving some slack.
- Connect the Modbus RS485 communication cable to the GND, - and + pins of the CN12 connector.

Use the table below to connect the communication cables from the accessories to the **eLuxWallbox**.

Single-Phase.

PowerMeter (DPM)	MIDcounter	eLuxWallbox
EM111DINAV51XS1X - EM111DINMV51XS1X	EM111DINAV81XS1PFB	CN12
GND (7)	GND (7)	GND
A- (8) / T*(5)	A- (8)	-
B+ (6)	B+ (6)	+
EM111DINAV51XS1X - EM111DINMV51XS1X	7M 24.8.230.0210	CN12
GND (7)	SC	GND
A-(8) / T*(5)	B-	-
B+ (6)	A+	+
EM111DINAV81XS1PFB	EM111DINAV81XS1PFB	CN12
GND (7)	GND (7)	GND
A-(8) / T*(5)	A- (8)	-
B+ (6)	B+ (6)	+
EM111DINAV81XS1PFB	7M 24.8.230.0210	CN12
GND (7)	SC	GND
A-(8) / T*(5)	B-	-
B+ (6)	A+	+
7M 24.8.230.0210	EM111DINAV81XS1PFB	CN12
SC	GND (7)	GND
B-	A- (8)	-
A+	B+ (6)	+
7M 24.8.230.0210	7M 24.8.230.0210	CN12
SC	SC	GND
B-	B-	-
A+	A+	+

Three-Phase.

PowerMeter (DPM)	MIDcounter	eLuxWallbox
EM330DINAV53HS1X	EM340DINAV23XS1PFB	CN12
GND (13)	GND (10)	GND
A-(12) / T*(10)	A-(9)	-
B+ (11)	B+ (8)	+
EM330DINAV53HS1X	7M.38.8.400.0212	CN12
GND (13)	SC	GND
A-(12) / T*(10)	B-	-
B+ (11)	A+	+
EM340DINAV23XS1PFB	EM340DINAV23XS1PFB	CN12
GND (10)	GND (10)	GND
A-(9) / T*(7)	A-(9)	-
B+ (8)	B+ (8)	+
EM340DINAV23XS1PFB	7M.38.8.400.0212	CN12
GND (10)	SC	GND
A-(9) / T*(7)	B-	-
B+ (8)	A+	+
7M.38.8.400.0212	EM340DINAV23XS1PFB	CN12
SC	GND (10)	GND
B-	A-(9)	-
A+	B+ (8)	+
7M.38.8.400.0212	7M.38.8.400.0212	CN12
SC	SC	GND
B-	B-	-
A+	A+	+

*A 120 Ω terminating resistor must be installed on the devices at the ends of the Modbus chain. The resistor is present by default in the **eLuxWallbox**. Gavazzi models have a built-in resistor, which can be enabled by making a jumper between these terminals.

4. PowerMeter (DPM) and MIDcounter configuration

Power on the **PowerMeter (DPM)** and/or the **MIDcounter** when the electrical installation and communication installation are complete. Then proceed with the configuration on the display of the meters.

The configuration varies depending on the model.

4.1. Finder models

The following actions help to understand how to set Finder energy meters:

- Press the touchscreen button (a,b) to move between menus and parameters;
- Long press (~ 2 seconds) the touchscreen button (a,b) to enter and confirm selections

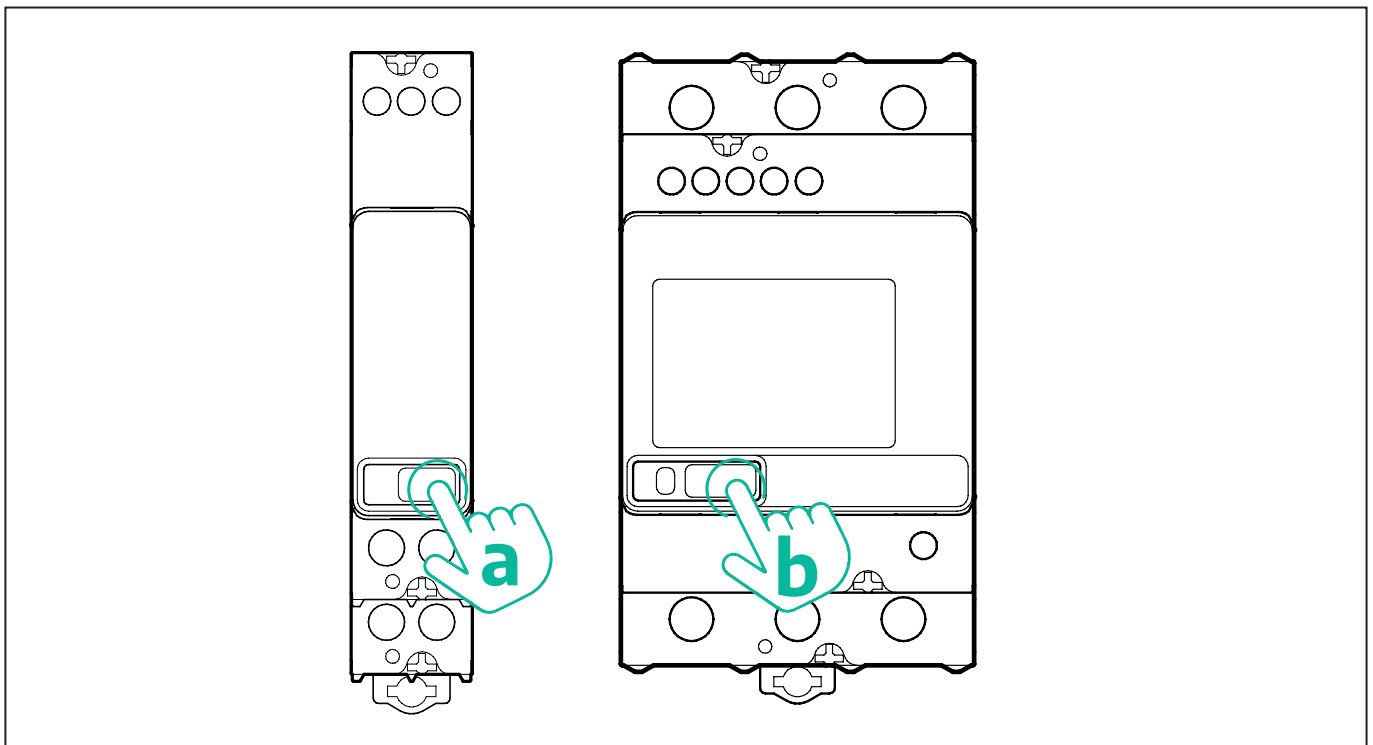

Follow the next steps to correctly configure the single-phase or three-phase Finder energy meters:

- When powering up the energy meter for the first time, long press the touchscreen button (a,b) until the display text blinks in order to enter the "MAIN" menu;
- Scroll the "MAIN" menu pressing the touchscreen button (a,b), then select "SETTING" ("SET" on single-phase meter). Long press to enter the selection.
- Scroll the "SETTING" menu pressing the touchscreen button (a,b), then select "COMMUNICATION" ("COMM" on single phase meter). Long press to enter the selection.
- Insert the correct values indicated in the table below. To modify the value press the touchscreen button (a,b), long press to confirm.

Only for three-phase Finder meter (in addition to previous options):

- Long press the touchscreen button (a,b) until the display text blinks in order to enter the "MAIN" menu (or return to the "MAIN" menu)
- Scroll the "MAIN" menu pressing the touchscreen button (a,b), then select "INSTALLATION". Long press the touchscreen button (a,b) to enter the selection
- Scroll the "INSTALLATION" menu pressing the touchscreen button (a,b) and then select the following option
 - "Communication mode" = "3L+N, L+N-Arithmetic"
 - Once the correct option is confirmed, enter the password: "DCBA" **Attention:** configuration cannot be modified after entering the password **DCBA**
 - Confirm the change selecting "Yes" when prompted.

ALL FINDER MODELS	PowerMeter (DPM)	MIDcounter
DEVICE ADDRESS	1	2
BITS PER SECOND (BAUD)	38400 bit/s	38400 bit/s
PARITY	Even	Even
STOP BIT	1	1
Additional for three-phase type		
	PowerMeter (DPM)	MIDcounter
COMMUNICATION MODE	3L+N, L+N-Arithmetic	3L+N, L+N-Arithmetic
PASSWORD	DCBA	DCBA

4.2. Gavazzi models

The following actions help to understand how to set Gavazzi energy meters:

- Press the touchscreen buttons (c, d, e, g) to move between menus and values
- press (~ 2 seconds) the touchscreen button (d, f) to enter the menu and confirm selections

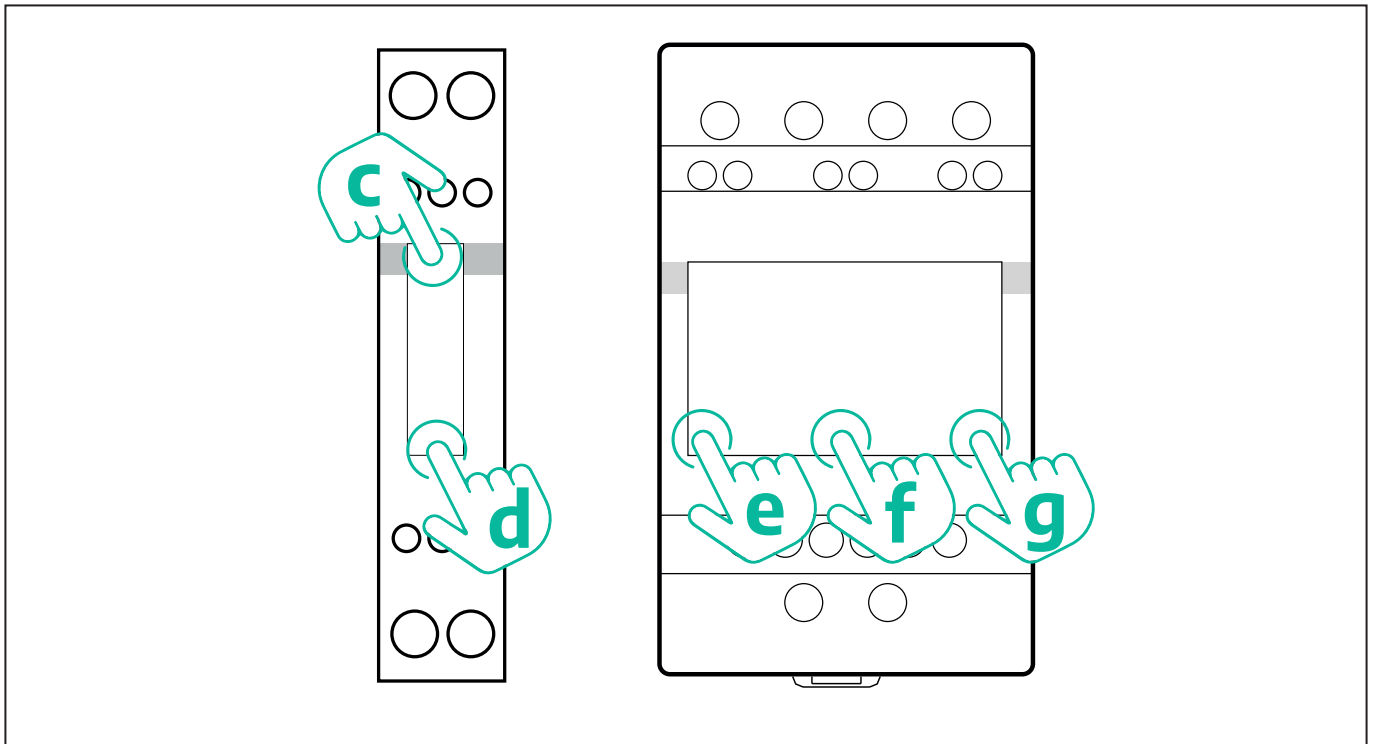

Follow the next steps to correctly configure the single-phase Gavazzi direct and indirect energy meters.

- When powering up the energy meter for the first time, long press the touchscreen button (d) until the password appears on the screen
- Long press the buttons (c, d) simultaneously in order to confirm the password "0000" and enter the "MAIN" menu
- Scroll the "MAIN" menu pressing the upper button (c) and then select the following options in the table below

Follow the next steps to correctly configure the three-phase Gavazzi direct and indirect energy meters:

- When powering up the energy meter for the first time, long press the central button (f) until the password appears on the screen;
- Long press the buttons (e, g) simultaneously in order to confirm the password "0000" and enter the "MAIN" menu
- Scroll the "MAIN" menu pressing the buttons (e or g) and then select the options in the table below

ALL GAVAZZI MODELS	PowerMeter (DPM)	MIDcounter
PASS	0000	0000
ADDRESS	001	002
BAUD	38.4	38.4
PARITY	Even	Even
Additional for three-phase type		
	PowerMeter (DPM)	MIDcounter
SYSTEM	3Pn	3Pn
ADDRESS	001	002

4.3. Device configuration summary

EM340DINAV23XS1PFB / EM330DINAV53HS1X		EM340DINAV23XS1PFB	
PASS	0000	PASS	0000
SYSTEM	3Pn	SYSTEM	3Pn
ADDRESS	1	ADDRESS	2
BAUD	38.4	BAUD	38.4
PARITY	EVEN	PARITY	EVEN

EM111DINAV81XS1PFB / EM111DINAV51XS1X / EM111DINMV51XS1X		EM111DINAV81XS1PFB	
PASS	0000	PASS	0000
ADDRESS	001	ADDRESS	002
BAUD	38.4	BAUD	38.4
PARITY	EVEN	PARITY	EVEN

7M 24.8.230.0210		7M 24.8.230.0210	
DEVICE ADDRESS	__ 1	DEVICE ADDRESS	__ 2
BITS PER SECOND (BAUD)	38400 bit/s	BITS PER SECOND (BAUD)	38400 bit/s
PARITY	EVEN	PARITY	EVEN
STOP BIT	1	STOP BIT	1

7M.38.8.400.0212		7M.38.8.400.0212	
DEVICE ADDRESS	__ 1	DEVICE ADDRESS	__ 2
BITS PER SECOND (BAUD)	38400 bit/s	BITS PER SECOND (BAUD)	38400 bit/s
PARITY	EVEN	PARITY	EVEN
STOP BIT	1	STOP BIT	1
CONNECTION MODE	3L+N, L+N - Arithmetic	CONNECTION MODE	3L+N, L+N - Arithmetic
PASSWORD	DCBA	PASSWORD	DCBA

4.4. PowerMeter (DPM) and MIDcounter configuration on APP

To complete installation, the final configuration of the **eLuxWallbox** and its accessories should be set via the dedicated app

PowerUp is a smartphone app for qualified installers only, available via Google Play™ and Apple Store®. The configuration is carried out via a Bluetooth connection. The wallbox cannot operate correctly if not configured via the app.



NOTICE: Make sure you have the latest version of PowerUp to have access to all of the features.

Follow the instructions below to get started with the app:

Download PowerUp to your smartphone and activate Bluetooth on the smartphone.



Scan **eLuxWallbox** QR code to pair it with the app. The QR Code can be found on the side of the charger.



Once paired, complete the configuration set up of **eLuxWallbox** and its Accessories by clicking on the parameter to be configured.

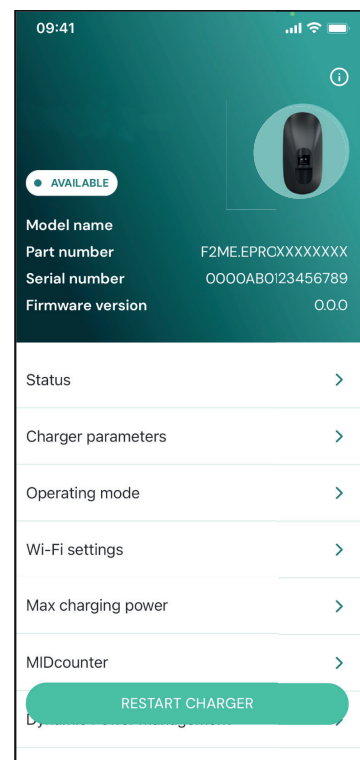

4.5. PowerMeter (DPM) configuration

To complete installation of the **PowerMeter (DPM)**, follow the steps below:

Select "**DPM PowerMeter**" on the homepage

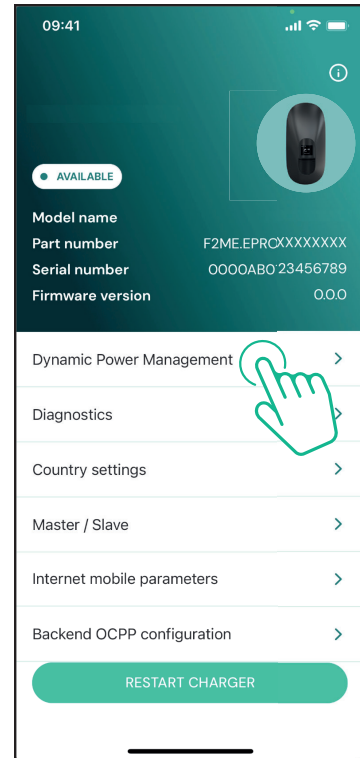

Select the **PowerMeter** type from the drop-down menu, matching the model installed.

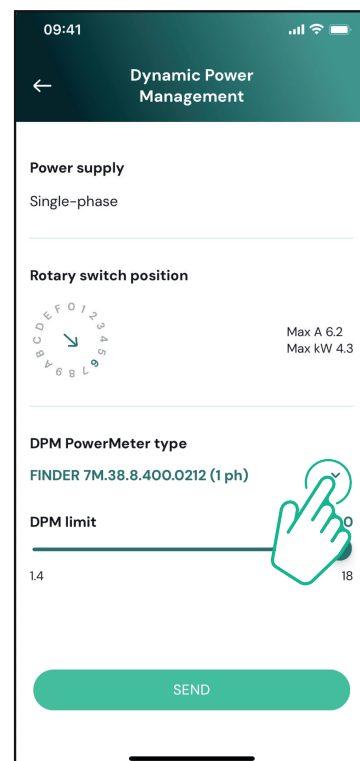

Enter the value of the user contractual power as **DPM** power limit.

For Indirect Meter only - Set the CT current ratio with the slider.

- With CTV 60 A set 60 as Current ratio
- With CTA 100 A set 20 as Current ratio
- With CTA 150 A set 30 as Current ratio

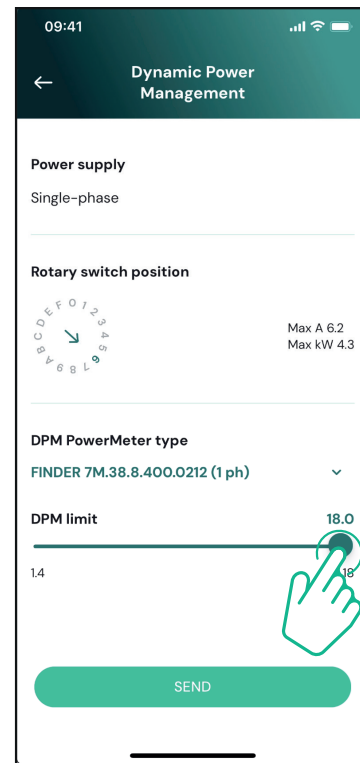

Click "Send" and confirm on the pop-up to restart **eLuxWallbox**.

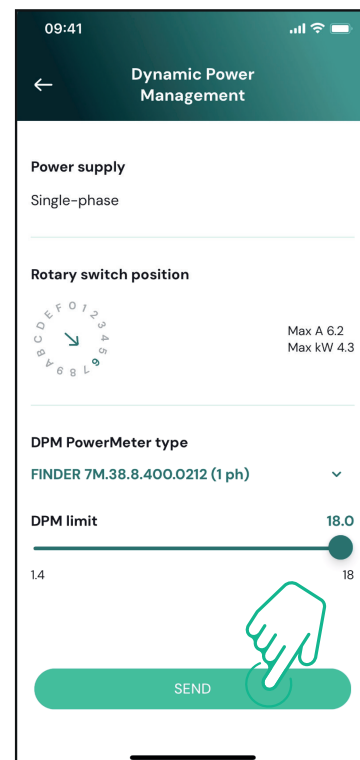

4.6. MIDcounter configuration

To complete installation of the **MIDcounter**, follow the steps below:

Select "**MIDcounter**" on the homepage

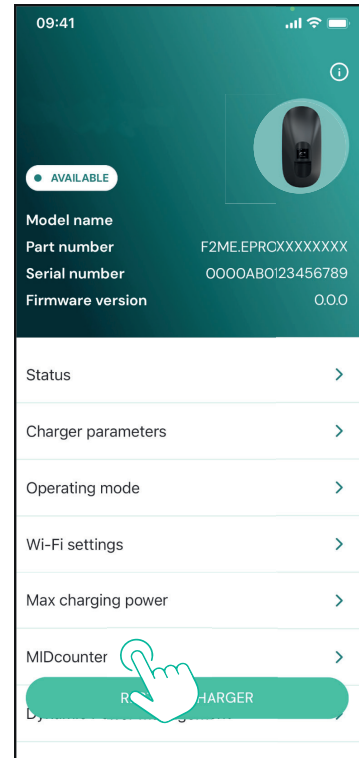

Select the **MIDcounter** type from the drop down menu, based on the model installed.

Select "OFF" from the drop down menu to disable the **MIDcounter** configuration.

Click "Send" to confirm.

To make the changes effective, click on the back arrow in the top left corner and restart **eLuxWallbox** through the dedicated button in the homepage.

If the installation has both the **PowerMeter (DPM)** and the **MIDcounter** it is possible to proceed with **DPM** configuration before restarting.

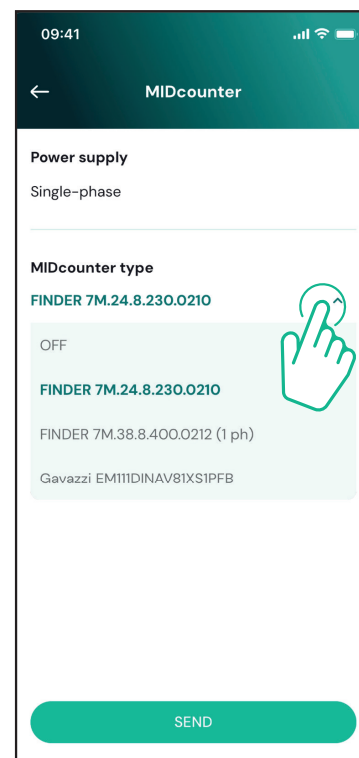

5. TROUBLESHOOTING

Error conditions are stored in the diagnostic logs and shown on the charger panel:

- On the **eLuxWallbox Move** model, the LED bar blinks red. See the **Diagnostic** section of PowerUP or the end-user App for the detailed error code.
- On the **eLuxWallbox** model, the display shows the error code, which is also available in the **Diagnostic** section of PowerUP.

When an error occurs, the charge is interrupted, and the socket is unlocked to allow you to disconnect the plug.

The following table provides a list of errors that can occur and the relative troubleshooting. If the error persists, note the serial number on the charger label and contact Customer Service.

Error code / issue	"Error Description"	Troubleshooting
100	Lack of power supply	<p>Check if the circuit breaker is ON. Check that the CN1 cabling is correct. Check the voltage in CN1.</p>
101	Overheating	<p>Disconnect the Type 2 cable, wait for the temperature to drop, then the error will clear.</p> <p>To restart the charging session, plug in the cable again. Make sure that installation site is compatible with temperature range (25°C/+50°C without direct exposure to sunlight)</p>
102	Communication error between MCU and MPU.	<p>Restart the charger from the circuit breaker, leaving the charger switched off for at least 60 seconds.</p>
103	Hardware fault, ground protection device error (GPD error)	<p>Check the cabling on CN1:</p> <ul style="list-style-type: none"> - in single-phase, make sure that ground cable is connected to PE, the Neutral cable is connected to N and the phase cable to T - in three-phase, make sure that the ground cable is connected to PE, the Neutral cable is connected to N and the phase cables L1, L2 and L3 are connected to T, S, and R. <p>Check whether the voltage difference between PE and N does not exceed 10V. Check PE connection</p> <p>If all connections are checked and the error persists, open the charger and modify the configuration of the Dipswitch (SW2) connector.</p>

104	Hardware fault, residual current monitor AC error. (RCM AC trip)	<p>Try to start a new charging session, removing and plugging in all the connectors.</p> <p>If the problem persists, check for the presence of any problems in the charging cable or vehicle inlet.</p> <p>If the cables and the EV don't show any problem, check CN27 connector and RCM cable.</p>
105	Hardware fault, residual current monitor DC error. (RCM DC trip)	<p>Check that the problem is not with the cable or vehicle. If possible, try another charging session with a different cable or vehicle.</p>
106	Internal meter error	<p>Restart the charger from the circuit breaker, leaving the charger switched off for at least 60 seconds.</p>
107	PowerMeter (DPM) communication error	<p>Check that the communication configuration on the DPM PowerMeter device is correct.</p> <p>Check that the DPM model configuration in the installer App is correct.</p> <p>Check the communication cable wiring on CN12.</p> <p>Check that the communication cable used is suitable for Modbus RS485 and cable length.</p>
108	Configuration Error, Rotary switch position (supply type) is not consistent with the DPM/ MID type.	<p>Check the position of the rotary switch. If it is not consistent with the 1-ph/3-ph installation, change it according to the table in the manual, then restart the charger.</p> <p>If the accessories (DPM/MID) are not installed, make sure that the function is disabled in the installer App.</p> <p>If the accessories (DPM/MID) are installed, check that the correct model is selected on the installer App. Then restart the charger.</p>
109	Main/secondary RS485 communication error	<p>Check the configuration of the Main/Secondary set up from installer App.</p> <p>Check that the Main charger is available.</p> <p>Check that the wiring of the communication cable on CN9 and CN10 is correct.</p> <p>Check that the communication cable used is suitable for Modbus RS485.</p>

110	MIDcounter communication error	<p>Check that the communication configuration on the MIDcounter device is correct.</p> <p>Check the communication cable wiring on CN12.</p> <p>Check that the communication cable used is suitable for Modbus RS485.</p> <p>Check that the MID model configuration in the installer App is correct.</p>
300	Inconsistency between the charger contactor command and feedback	<p>Restart the charger from the circuit breaker, leaving the charger switched off for at least 60 seconds.</p> <p>If error persists even after restart, call Customer Service.</p>
301	Short circuit detected on the Control Pilot line.	<p>With the charger switched off, check that there is no damage and no defects inside and outside the socket (if so, avoid using the charger and contact Customer Service).</p> <p>Check that the problem is not related to the cable or vehicle and try another charge session (with another vehicle or cable if possible).</p>
302	State E or F set on the Control Pilot line.	<p>With the charger switched off, check that there is no damage and no defects inside and outside the cable and its connectors (if so, avoid using it and attempt charge with another cable).</p>
303	Control Pilot disconnected.	<p>Check that the cable connectors are fully inserted inside the charger socket and vehicle inlet.</p>
304	Proximity Pilot disconnected.	<p>Check that the problem is not related to the cable or vehicle and try another charge session (with another vehicle or cable if possible).</p>
305	Broken Proximity Pilot detected.	<p>Check that the problem is not related to the cable or vehicle and try another charge session (with another vehicle or cable if possible).</p>
306	Diode fault detected on Control Pilot line (no - 12V).	<p>Attempt a new charging session unplugging and reinserting the cable from both the charger and vehicle inlet.</p>
307	Control Pilot disconnected.	<p>With the charger switched off, check that there is no damage and no defects inside and outside the cable and its connectors (if so, avoid using it and attempt charge with another cable).</p> <p>Check that the cable connectors are fully inserted inside the charger socket and vehicle inlet.</p> <p>Check that the problem is not related to the cable or vehicle and try another charge session (with another vehicle or cable if possible).</p>

308	Inconsistency between the motor command and feedback, or the motor is in an error condition.	<p>Attempt a new charging session unplugging and reinserting the cable from both the charger and vehicle inlet.</p> <p>Check that the cable connectors are fully inserted inside the charger socket and vehicle inlet.</p>
309	Motor check error during EVSE initialization phase.	Restart the charger from the circuit breaker, leaving the charger switched off for at least 60 seconds.
310	Error detected before charging (PP not detected, or motor fault, or CP not detected).	<p>With the charger switched off, check that there is no damage and no defects inside and outside the cable and its connectors (if so, avoid using it and attempt charge with another cable).</p> <p>Check that the cable connectors are fully inserted inside the charger socket and vehicle inlet.</p>
311	Error detected after charging (motor fault, or CP not disconnected).	Check that the problem is not related to the cable or vehicle and try another charge session (with another vehicle or cable if possible).
312	Emergency stop received from the MPU.	Restart the charger from the circuit breaker, leaving the charger switched off for at least 60 seconds.
313	Current detected during charging, with 100% duty cycle on the Control Pilot line.	Check that the problem is not cable nor vehicle related, attempt a new charging session with another cable and/or charger.
315	Current over limits on phase L1	Unplug the cable, if possible lower the power of charge on the vehicle side and attempt a new charging session.
316	Current over limits on phase L2	
317	Current over limits on phase L3	
318	Voltage below a threshold on phase L1	<p>Check the rotary switch position is consistent with 1-ph/3-ph installation.</p> <p>Check that the voltage on CN1-T is above 196 V.</p> <p>If the voltage is below 196 V, check the electric system or contact the energy supplier.</p> <p>If an error occurs during vehicle charging, try to reduce the set-up charging power and verify that the electric system is correctly dimensioned for the power drawn by the vehicle.</p>

319	Voltage below a threshold on phase L2	The rotary switch is in a three-phase position. Check that the intended installation is in three-phase. If not, select the correct rotary switch position as per Installation Manual.
320	Voltage below a threshold on phase L3	<p>Check that the voltage on CN1-S and R is above 196 V. If the voltage is below 196V, check the electric system or contact the energy supplier.</p> <p>If an error occurs during vehicle charging, try to reduce the set-up charging power and verify that the electric system is correctly dimensioned for the power drawn by the vehicle.</p>
321	Forbidden state change (IEC 61851-1)	<p>EV does not meet IEC 61851-1 standards for starting a charge session.</p> <p>Attempt a new charging session unplugging and reinserting the cable from both the charger and vehicle inlet.</p> <p>If the error persists, contact the vehicle manufacturer.</p>
	Display/LED stuck in Welcome mode (LED blinks red-green-blue)	Restart the charger from the circuit breaker, leaving the charger switched off for at least 60 seconds.
	LED or display does not light up at startup	
	The charger does not start	<p>Let the unit restart, it may take up to 30 seconds.</p> <p>Check if the circuit breaker is ON.</p> <p>Check that the CN1 cabling is correct.</p> <p>Check the voltage in CN1.</p> <p>Restart the charger from the circuit breaker, leaving the charger switched off for at least 60 seconds.</p>
	Cable stuck in the charger socket	Turn off the charger from the circuit breaker, then remove the cable.
	Suspended Charging with solid green LED/ message on the display. The charging session is suspended by the DPM or the EV. The session may resume.	<p>Verify that the max power in the DPM power limit section of the installer App is consistent with the contract power value in kW as indicated in the user's electricity contract. If the value is correct, wait for the charging session to resume or turn off some house loads.</p> <p>In the case of 3-ph installation, verify that the electrical loads are well balanced on the phases of the domestic system.</p>

	<p>App pairing does not complete after QR scan.</p>	<p>Check the integrity of the QR code on the label. Update the App to the latest version. Close and restart the App, then try again. Restart the charger from the circuit breaker, leaving the charger switched off for at least 60 seconds.</p>
--	---	---

6. CLEANING

Cleaning the outside of the device is always recommended when necessary and should be carried out using a soft damp cloth with a mild detergent. When finished, wipe off any traces of moisture or liquid with a soft dry cloth.



CAUTION: Avoid strong jets of air or water as well as the use of soaps or detergents that are too harsh and corrosive for the materials of the charger.

7. PACKAGING DISPOSAL



Dispose of packaging in an environmentally friendly manner. The materials used for packaging this product can be recycled and must be disposed of in compliance with the legislation in force in the country of use. The following disposal directions will be found on the packaging based on the type of material.



NOTE: Further information about current disposal facilities can be obtained from local authorities.

8. ASSISTANCE

If you have any questions about the installation of **eLuxWallbox**. For any other information or requests for support, please contact Free2move eSolutions S.p.A. through the relevant section of its website: www.esolutions.free2move.com.

9. DISCLAIMER

Free2move eSolutions S.p.A. will not be held responsible for any damage directly or indirectly caused to people, things or animals due to the failure to comply with all the provisions set out in this Manual, and the warnings regarding the installation and maintenance of **eLuxWallbox**.

Free2move eSolutions S.p.A. reserves all rights to this document, the article and the illustrations it contains. The reproduction, whole or in part, disclosure to third parties or use of its contents is prohibited without the prior written consent of Free2move eSolutions S.p.A.

Any information in this manual may be changed without prior notice and does not represent any obligation on the part of the manufacturer. Images in this manual are for illustrative purposes only and might differ from the delivered product.

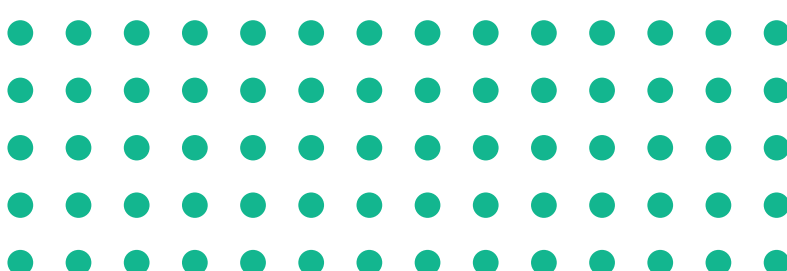

Registered office

Free2move eSolutions S.p.A.

Piazzale Lodi, 3

20137 Milan - Italy

www.esolutions.free2move.com

CZ

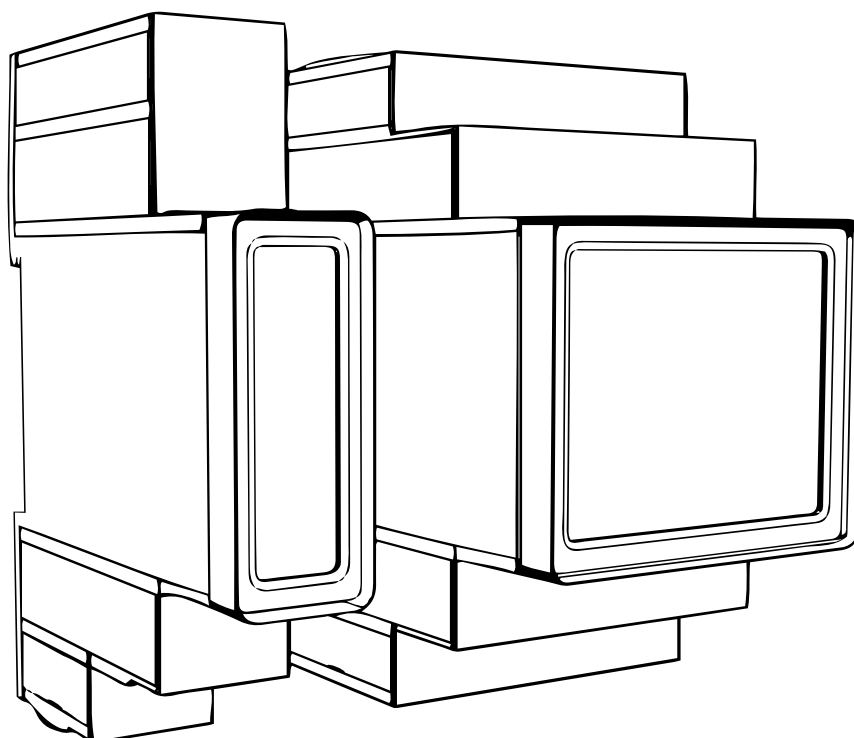

LuxWallbox

Manuál k příslušenství



Pro bezpečné a správné použití,
postupujte podle těchto pokynů.
Uchovávejte je pro budoucí použití

Obsah

1. ÚVOD	4
1.1. Účel manuálu.....	4
1.2. Identifikace výrobce.....	4
1.3. Struktura manuálu k příslušenství.....	4
1.4. Bezpečnost.....	5
1.5. Osobní ochranné pracovní prostředky (OOPP).....	6
1.6. Záruční a dodací podmínky	6
1.7. Seznam dokumentů.....	7
1.8. Varování	7
2. OBECNÉ INFORMACE.....	8
2.1. Rozsah použití	9
3. INSTALACE PŘÍSLUŠENSTVÍ	10
3.1. Instalace elektroměru PowerMeter (DPM).....	10
3.2. Instalace měřiče MIDcounter.....	15
3.3. Instalace komunikačního kabelu.....	17
3.4. Kombinovaná instalace měřičů MIDcounter a PowerMeter (DPM).....	19
4. Konfigurace měřičů PowerMeter (DPM) a MIDcounter	22
4.1. Modely Finder	22
4.2. Modely Gavazzi.....	24
4.3. Přehled konfigurace zařízení	25
4.4. PowerMeter (DPM) a MIDcounter: konfigurace v aplikaci	26
4.5. Konfigurace elektroměru PowerMeter (DPM).....	28
4.6. Konfigurace přístroje MIDcounter	30
5. ŘEŠENÍ PROBLÉMŮ	31
6. ČISTĚNÍ	36
7. LIKVIDACE OBALU	36
8. PODPORA	37

9. ODMÍTNUTÍ ODPOVĚDNOSTI37

1. ÚVOD

1.1. Účel manuálu

Tento instalační manuál slouží jako návod pracovníkům, aby mohli pracovat bezpečně a vykonávat činnosti potřebné k zachování nabíjecí stanice v řádném provozuschopném stavu.

Účelem tohoto dokumentu je podpora kvalifikovaných techniků, kteří prošli příslušným zaškolením a prokázali patřičné znalosti dovednosti při konstrukci, instalaci, provozu a údržbě elektrických zařízení.

Používáním nabíjecí stanice jiným způsobem, než je uvedené v tomto manuálu, se naruší ochrana poskytovaná touto stanicí. Tento dokument obsahuje informace o instalaci nabíjecí stanice.

Tento dokument byl pečlivě zkontrolován výrobcem Free2Move eSolutions S.p.A., ale přehlédnutí nelze zcela vyloučit. Případné chyby nahlaste společnosti Free2Move eSolutions S.p.A. S výjimkou výslovných smluvních závazků nemůže společnost Free2Move eSolutions S.p.A. za žádných okolností nést odpovědnost za jakoukoli ztrátu nebo škodu vzniklou použitím tohoto manuálu či instalací zařízení. Tento dokument byl původně vyhotoven v angličtině. V případě jakýchkoli nesrovnalostí nebo pochybností si u vyžádajte u firmy Free2Move eSolutions S.p.A. dokument v originálním znění.

1.2. Identifikace výrobce

Výrobce nabíjecí stanice:

Free2move eSolutions S.p.A.

Piazzale Lodi, 3

20137 Milan – Italy

www.esolutions.free2move.com

1.3. Struktura manuálu k příslušenství





Tento manuál je rozdělený do kapitol podle témat a jsou v něm uvedené všechny informace potřebné k bezpečné instalaci nabíjecí stanice.

Jednotlivé kapitoly je rozdělené na části obsahující základní body. Každá taková část může mít titul, podtitul a popis.

1.4. Bezpečnost

V manuálu jsou uvedené důležité bezpečnostní pokyny, které je nezbytné dodržovat při instalaci nabíjecí stanice.

Pro splnění tohoto cíle jsou v tomto manuálu uvedena upozornění obsahující zvláštní pokyny. Tyto pokyny jsou zvýrazněné příslušným textovým polem a symbolem. Jsou udělené pro zajištění bezpečnosti pracovníků při výkonu popsanych činností a pro zabránění škodám na nabíjecí stanici a/nebo majetku:

	<p>Význam symbolu: NEBEZPEČÍ</p> <p>Tento symbol označuje nebezpečné situace pro vás i ostatní. Zapamatujte si jej. Nedodržením pokynů vznikne riziko bezprostřední nebezpečné situace. Pokud se jí nevyhnete, může to způsobit okamžitou smrt nebo vážný či trvalý úraz.</p>
	<p>Význam symbolu: VAROVÁNÍ</p> <p>Tímto symbolem jsou označené informace týkající se bezpečnosti. Nedodržením pokynů vznikne riziko potenciálně nebezpečné situace. Pokud se jí nevyhnete, může to způsobit smrt nebo vážný úraz.</p>
	<p>Význam symbolu: VÝSTRAHA</p> <p>Tímto symbolem jsou označené informace týkající se bezpečnosti. Zapamatujte si jej. Nedodržení těchto pokynů může vést k úmrtí, vážnému zranění nebo poškození zařízení.</p>
	<p>Význam symbolu: POZNÁMKA</p> <p>Obsahuje doplňující informace k poskytnutým pokynům.</p>
	<p>Význam symbolu: UPOZORNĚNÍ</p> <p>Obsahuje pokyny k postupům nezbytným pro výkon činností, u nichž nehrozí úraz osob.</p>

Instalaci smí provádět pouze odborní technici. Musí být vyprojektovaný a nainstalovaný moderní rozvod elektrické energie, který musí být certifikovaný podle nejnovějších vnitrostátních zákonů a předpisů a musí být v souladu s danou smlouvou o dodávkách energie.

Osoby obsluhující stanici mají za povinnost si pročíst tento manuál, plně mu porozumět a přesně dodržovat pokyny v něm uvedené.

Při nesplnění podmínek stanovených v tomto dokumentu nenese společnost Free2Move eSolutions S.p.A. odpovědnost za škody způsobené osobám a/nebo na majetku či zařízení.





VAROVÁNÍ: Instalace musí být provedena v souladu s platnými předpisy v zemi instalace a v souladu se všemi bezpečnostními předpisy pro provádění prací na elektrických zařízeních.

1.5. Osobní ochranné pracovní prostředky (OOPP)

Osobním ochranným pracovním prostředkem (OOPP) se rozumí jakékoli zařízení určené k nošení pracovníky za účelem jejich ochrany před jedním rizikem či několika riziky, která by mohla ohrozit jejich zdraví nebo bezpečnost na pracovišti, jakož i jakékoli zařízení nebo příslušenství určené k tomuto účelu.

Vzhledem k tomu, že jsou všechny OOPP uvedené v tomto manuálu určené k ochraně osob před zdravotními a bezpečnostními riziky, výrobce nabíjecí stanice, který je předmětem tohoto manuálu, doporučuje dodržovat přesně všechny pokyny v něm uvedené.

Seznam OOPP pro použití k ochraně pracovníků před zbytkovými riziky, která se vyskytují během instalací a výkonu údržby popsanych v tomto dokumentu, je uvedený níže.

Symbol	Význam
	Používejte ochranné rukavice
	Používejte antistatickou obuv



VAROVÁNÍ: Je na odpovědnosti provozovatele se seznámit s místní předpisy, porozumět jim a vyhodnotit, zda podmínky prostředí v místě instalace umožňují používat všechny osobní ochranné prostředky.

1.6. Záruční a dodací podmínky

Podrobnosti o záruce jsou uvedené v obchodních podmínkách, které jsou součástí kupní objednávky tohoto produktu a/nebo v balení produktu.

Společnost Free2Move eSolutions S.p.A. nenesé žádnou odpovědnost za nedodržení pokynů pro správnou instalaci ani za systémy nainstalovanými před dodanou stanicí či za ní.

Společnost Free2Move eSolutions S.p.A. nenesé odpovědnost za vady nebo nesprávné fungování způsobené chybným používáním nabíjecí stanice, poškozením při dopravě, specifickým stavem daného prostředí nebo instalací provedenou nekvalifikovanými osobami.

Společnost Free2move eSolutions S.p.A. nenesé odpovědnost za likvidaci nabíjecí stanice nebo jejích součástí v rozporu se zákony a předpisy platnými v zemi, kde je nainstalováno.



UPOZORNĚNÍ: Jakoukoli změnou, manipulací nebo úpravou hardwaru či softwaru, které nebyly výslovně sjednány s výrobcem, přestává bez prodlení platit záruka.

1.7. Seznam dokumentů

Kromě tohoto manuálu si můžete ke stanici stáhnout z webu: www.esolutions.free2move.com i následující dokumentaci.

1.8. Varování



NEBEZPEČÍ: Nebezpečí úrazu elektrickým proudem a požáru. Instalace musí být provedena v souladu s platnými předpisy v zemi instalace a v souladu se všemi bezpečnostními předpisy pro provádění prací na elektrických zařízeních.

- Před instalací nebo použitím stanice se ujistěte, že není poškozená žádná její součást. Poškozené součásti mohou způsobit úraz elektrickým proudem, zkrat a požár důsledkem přehřátí. Poškozené nebo vadné zařízení se nesmí používat.
- Stanici **eLuxWallbox** nainstalujte daleko od kanystrů s benzínem a hořlavých látek vůbec.
- Před instalací **příslušenství kompatibilních se stanicí eLuxWallbox** zkontrolujte, zda je odpojený hlavní přívod.
- **Příslušenství kompatibilní se stanicí eLuxWallbox** se smí používat je účely, pro které je určené.
- Nesprávně provedenou instalací může být uživatel vystaven rizikům.
- Nabíjecí stanice musí být připojená k elektrické síti, která je v souladu s místními a mezinárodními předpisy a všemi technickými požadavky uvedenými v tomto manuálu.
- Děti nebo jiné osoby, které nedokážou vnímat rizika spojená s instalací nabíjecí stanice, by mohly utrpět vážný až smrtelný úraz.
- Domácí mazlíčci či jiná zvířata musí být držena mimo zařízení a obalový materiál.
- Děti si nesmí hrát se zařízením, příslušenstvím ani obalem, v němž bylo zařízení dodáno.
- Ze stanice **eLuxWallbox** se smí sejmut pouze odnímatelný kryt. Přístup s oddělaným krytem je povolený pouze kvalifikovaným technikům provádějící instalaci, demontáž nebo údržbu nabíjecí stanice.
- Stanice **eLuxWallbox** se smí zapojit pouze do zdroje energie.
- Je nutno přijmout všechna nezbytná opatření k zajištění bezpečného provozu i v případě aktivních implantabilních zdravotnických prostředků. Případné nepříznivé účinky na zdravotnický prostředek ověřte u jeho výrobce.

2. OBECNÉ INFORMACE

Stanice **eLuxWallbox** řeší nabíjení střídavým proudem čistě elektrických vozidel a plug-in hybridů. Je ideální pro poloveřejné a rezidenční použití. Nabíjecí stanici lze pořídit ve třífázové nebo jednofázové konfiguraci. Je osazená zásuvkou typu 2.

Ve třífázové konfiguraci nabije nabíjecí stanice vozidla až do 22 kW; v jednofázové konfiguraci nabije stanice vozidla až do 7,4 kW. Nabíjecí stanice obsahuje i volitelné funkce pro konektivitu, jako je vzdálené monitorování prostřednictvím řídicí platformy eSolutions (CPMS). Konfiguraci je nutno dokončit aplikací **PowerUp**. Koncový uživatel může používat nabíjecí stanice **eLuxWallbox** prostřednictvím uživatelské aplikace eSolutions Charging. Obě aplikace jsou dostupné v obchodech Google Play™ a Apple Store®.

V nabíjecí stanici je vložena SIM karta pro připojení k mobilní síti 4G.

SIM karta se automaticky aktivuje při prvním zapnutí nabíjecí stanice.

V tomto dokumentu je popsáno, jak nainstalovat externí příslušenství kompatibilní s nabíjecí stanicí **eLuxWallbox**.

V tomto manuálu je popsáno následující externí příslušenství:

- **PowerMeter (DPM)**: je externí elektroměr pro ovládání funkcionality Dynamic Power Management (**DPM**), což je inteligentní funkcionalita umožňující dobít elektrické vozidlo napájením dostupným pouze v domácnosti, modulací nabíjecího výkonu a vyloučením nepříjemných výpadků.
- **MIDcounter**: certifikovaný měřič energie pro monitorování spotřeby nabíjecí stanice **eLuxWallbox** během nabíjení.

V tomto manuálu jsou uvedené charakteristik jednotlivých příslušenství, informace o modelech, pokyny k instalaci a finální konfigurace nabíjecí stanice.

eLuxWallbox je nakonfigurovaná pro použití s následujícím elektrickým příslušenstvím:

PowerMeter (DPM) nebo **MIDcounter**:

- Gavazzi, 1 f, přímé zapojení, 32 A
- Finder 1 f, přímé zapojení, 40 A
- Gavazzi, 3 f, přímé zapojení, 65 A
- Finder 3 f, přímé zapojení, 80 A

PowerMeter (DPM):

- Gavazzi, 1 f, nepřímé zapojení, 1x CT 100 A
- Gavazzi, 1 f, nepřímé zapojení, 1x CTV 60 A
- Gavazzi, 3 f, nepřímé zapojení, 3x CT 150 A



VAROVÁNÍ: Nepokoušejte se nainstalovat elektrické příslušenství, pokud nemáte stejnou kvalifikaci jako profesionální elektrotechnik. Mohlo by to vystavit vážnému nebezpečí a újmě vám a ostatním osobám, majetku nebo zvířatům ve vašem okolí.

Pro dokončení instalace je nutné nakonfigurovat stanici **eLuxWallbox** prostřednictvím příslušných aplikací:

	Instalační aplikace: PowerUp
Verze výrobku (EU):	EPRO23S224GWBAX
Verze výrobku (UK):	EPRO23S224GWBAS



VAROVÁNÍ: Kompatibilní jsou pouze elektrická příslušenství doporučená firmou Free2move eSolutions S.p.A. Instalaci musí provést kvalifikovaný technik v souladu s příslušnými předpisy.

2.1. Rozsah použití

Free2Move eSolutions S.p.A. odmítá veškerou odpovědnost za jakékoli škody způsobené nesprávnými nebo neopatrnými postupy.

Nabíjecí stanice se nesmí používat k jinému než předepsanému účelu.

Nabíjecí stanici nesmí používat děti ani osoby s omezenými duševními nebo fyzickými schopnostmi, ani dospělí nebo odborníci, pokud byly na stanici provedeny činnosti, které nejsou v souladu s tímto manuálem a průvodní dokumentací.

Nabíjecí stanice slouží jako je nabíjecí zařízení elektrických vozidel. Její charakteristiky odpovídají následující klasifikaci (podle IEC 61851-1):

- Napájení: trvale připojeno ke střídavé elektrické síti
- Výstup: Střídavý proud
- Podmínky prostředí: vnitřní / venkovní prostředí
- Pevná instalace:
- Ochrana proti úrazu elektrickým proudem: Třída I
- Klasifikace prostředí EMC: Třída B
- Typ nabíjení: Režim 3 podle standardu IEC 61851-1
- Volitelná funkce ventilace není podporovaná

3. INSTALACE PŘÍSLUŠENSTVÍ

Pro instalaci příslušenství je nutné použít komunikační kabely Modbus s následujícími charakteristikami:

- Modbus RS485 Twisted STP 2x2 AWG24 nebo s /FTP.7 vhodné pro instalaci do přívodního vedení 400 V
- Průřez vodiče: 0,5 mm²
- Délka odizolování: 10 mm
- Doporučená maximální délka: 150 m

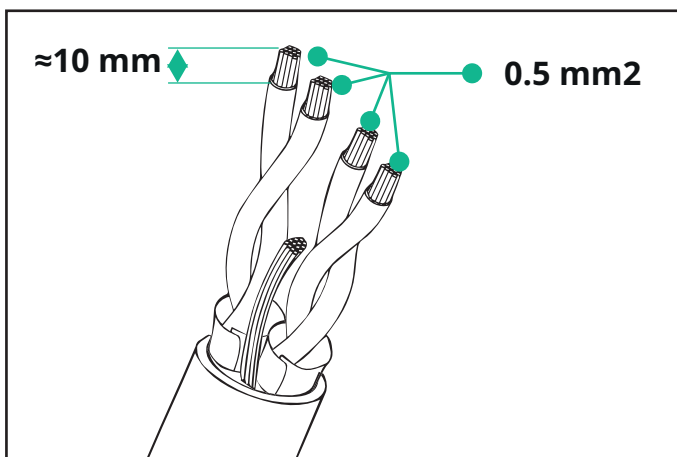

3.1. Instalace elektroměru PowerMeter (DPM)

PowerMeter (DPM) je externí elektroměr pro ovládání funkcionality Dynamic Power Management (**DPM**), což je inteligentní funkcionality umožňující dobít elektrické vozidlo napájením dostupným pouze v domácnosti, modulací nabíjecího výkonu a vyloučením nepřijemných výpadků. Pokud jsou během nabíjení používány i jiné spotřebiče, systém může modulovat nabíjecí výkon dodávaný do vozidla nebo nabíjení dočasně přerušit. Nabíjení se znovu spustí, jakmile vypnete některý domácí spotřebič.

Chytrá logika **DPM** funguje ve třífázové a jednofázové instalaci.



VAROVÁNÍ: Při instalaci do třífázového rozvodu zajistěte řádné vyvážení elektrických zátěží (včetně stanice) mezi fázemi elektrického rozvodu.



VAROVÁNÍ: Před prováděním jakékoli instalace nebo údržby na zařízení se musíte ujistit, že je vypnuté od zdroje.

Přímo zapojené modely elektroměru PowerMeter (DPM):

PowerMeter (DPM) nainstalujte za hlavní elektroměr. **PowerMeter (DPM)** musí měřit všechny elektrické zátěže včetně stanice **eLuxWallbox**.

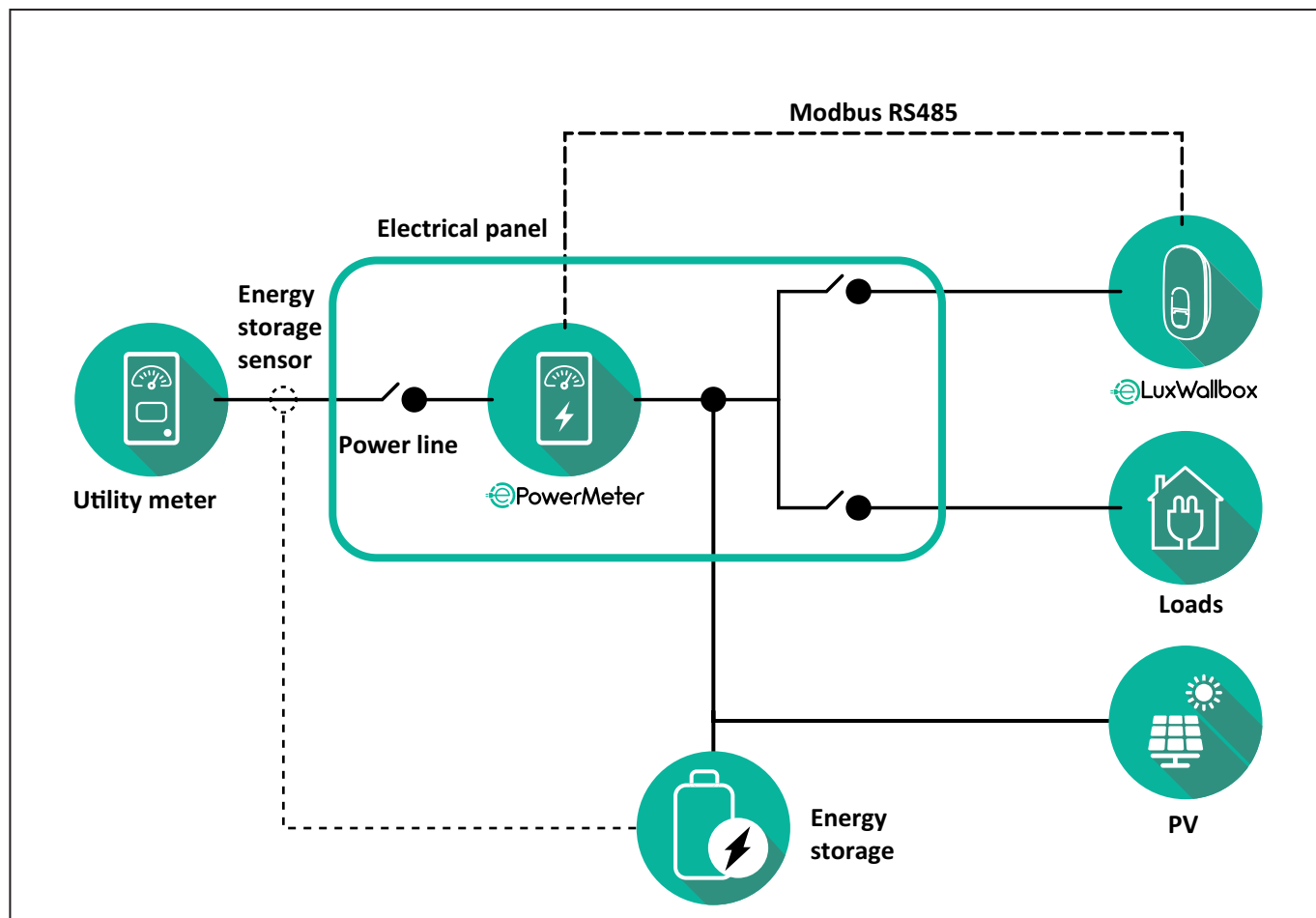

Přímo zapojené modely elektroměru PowerMeter:



VAROVÁNÍ: Instalaci je nutno provést pouze a jedině podle instalačního manuálu dodaného s elektroměrem.



POZNÁMKA: Elektroměr **PowerMeter** s přímým zapojením do jednofázového nebo třífázového obvodu připojte podle níže uvedených schémat.

Model Finder 1 f a 3 f

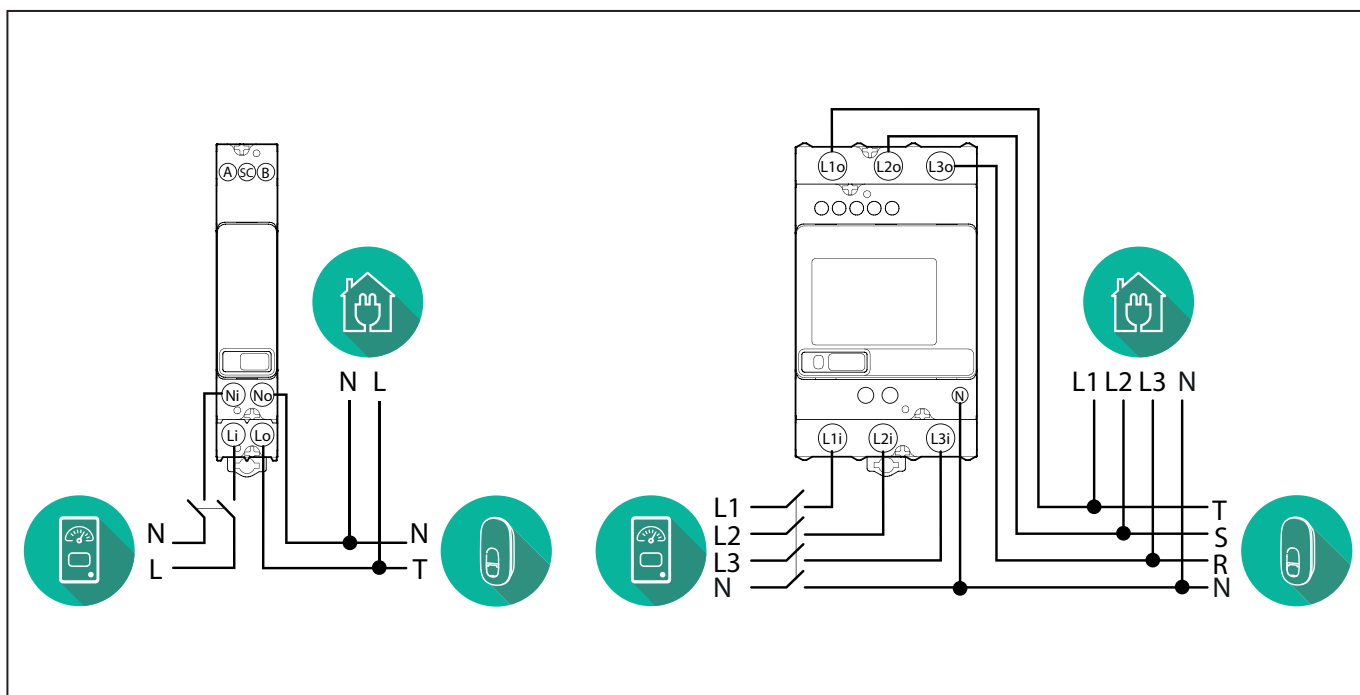

Model Gavazzi 1 f a 3 f

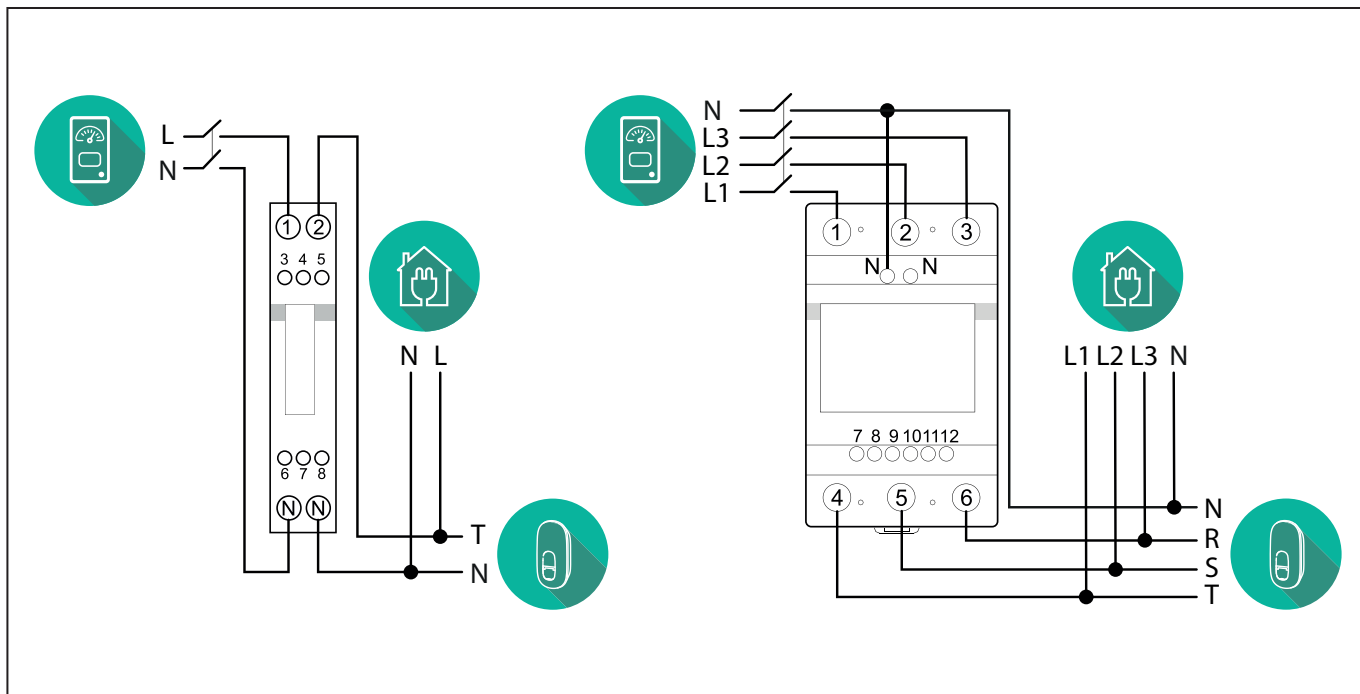

UPOZORNĚNÍ:



1) Pokud je zde PV, je nutno umístit **PowerMeter** mezi hlavní elektroměr a připojovací bod PV.

2) Pokud je zde domácí úložiště elektrické energie, je nutno **PowerMeter** umístit mezi připojovací bod tohoto úložiště a jeho měřicí snímač.

Nepřímo zapojené modely elektroměru PowerMeter:

Umístěte CT (měnič proudu) elektroměru **PowerMeter** za hlavní elektroměr a před hlavní spínač bytu/domu. Proudový transformátor musí měřit všechny elektrické zátěže včetně nabíjecí stanice **eLuxWallbox**.

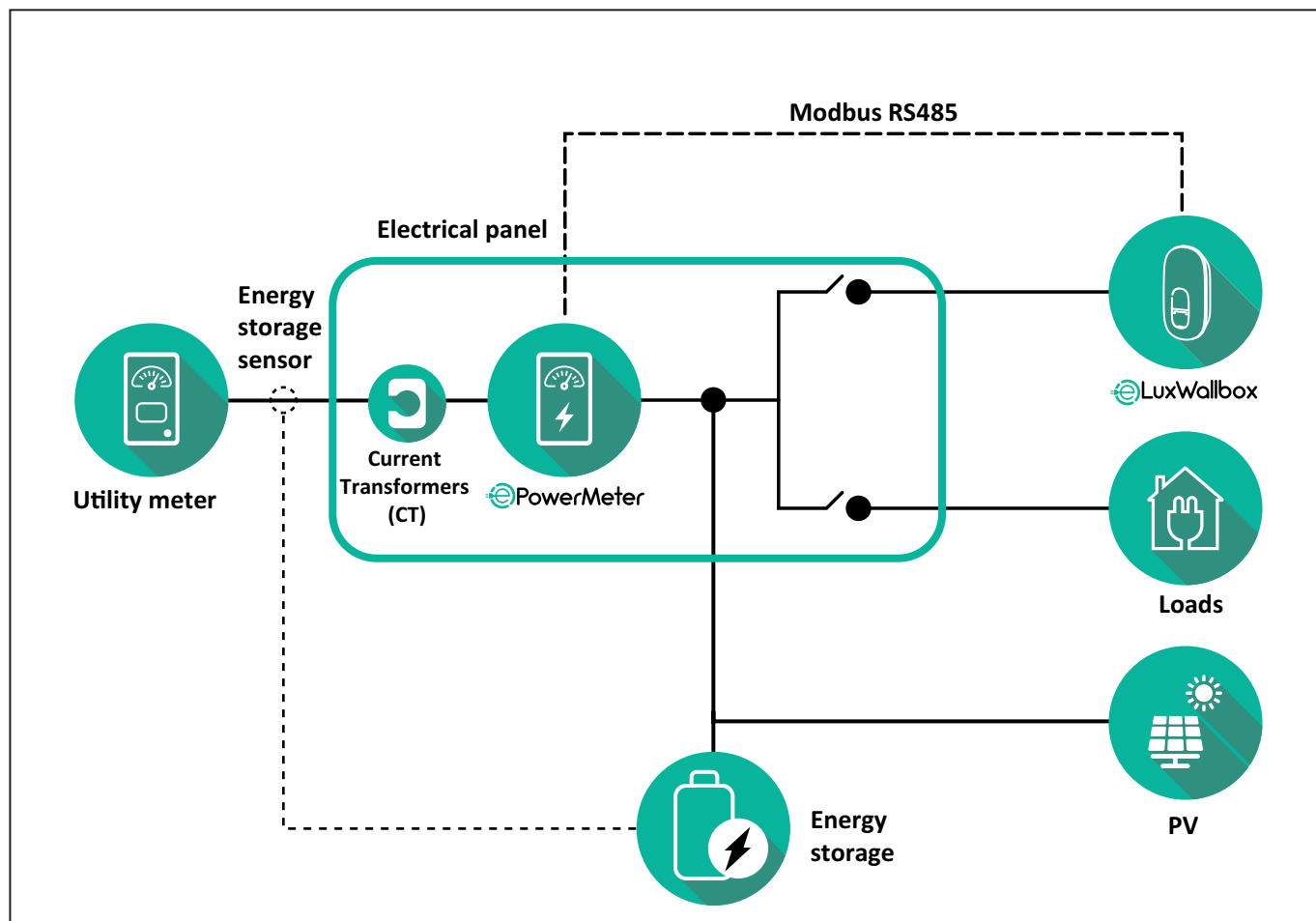

UPOZORNĚNÍ:



- 1) Pokud je zde PV, je nutno měnič proudu (CT) elektroměru **PowerMeter** umístit mezi připojovací bod PV a hlavní elektroměr.
- 2) Pokud je zde domácí úložiště elektrické energie, je nutno měnič proudu (CT) elektroměru **PowerMeter** umístit mezi připojovací bod tohoto úložiště a jeho měřicí snímač.

Měníč proudu (CT) připojte podle pokynů uvedených v instalačním manuálu elektroměru. Šipku na měniči proudu CT nastavte po směru zátěží.

Elektroměr **PowerMeter** s nepřímým zapojením do jednofázového nebo třífázového obvodu připojte podle níže uvedených schémat.

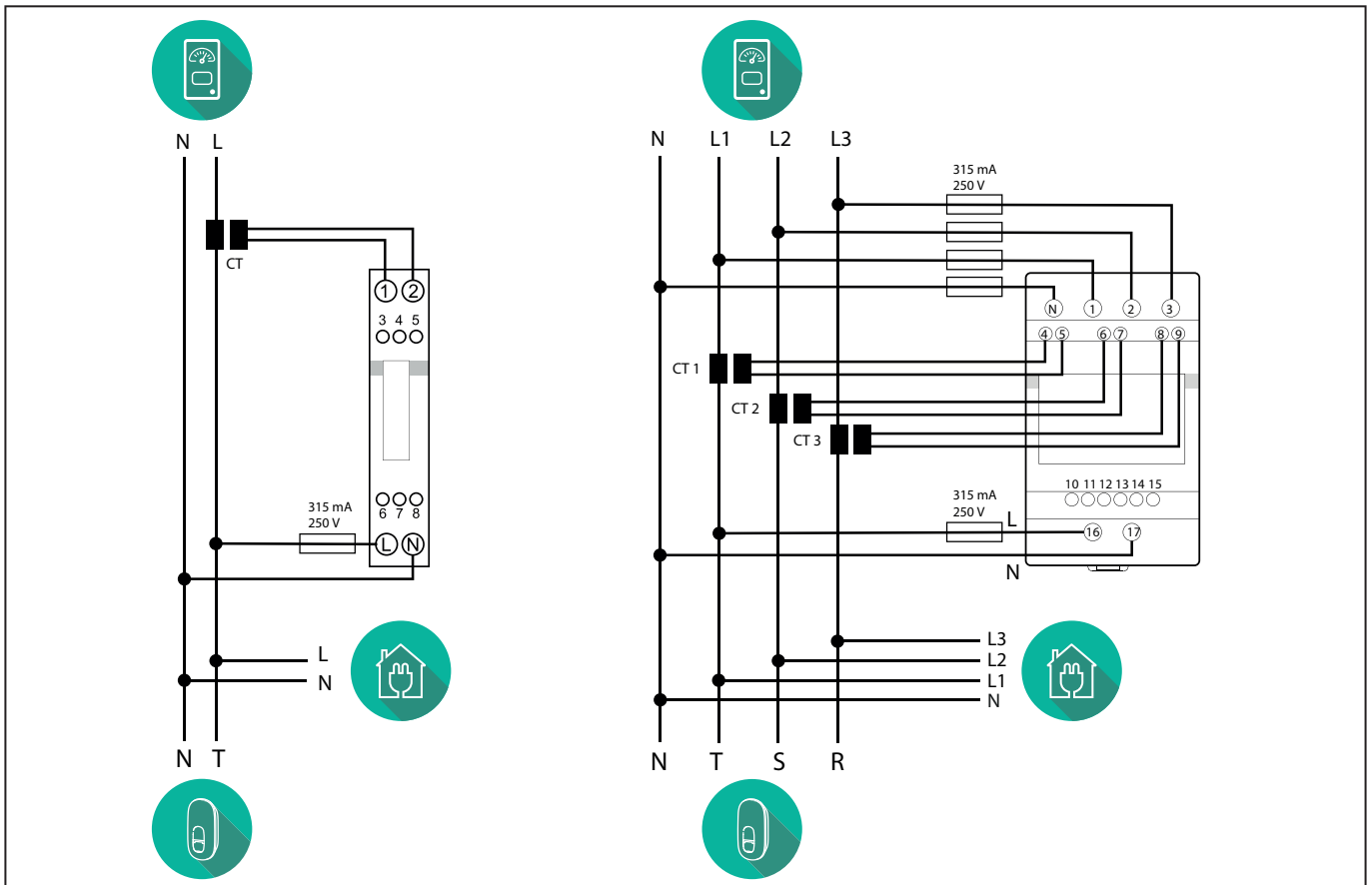

3.2. Instalace měřiče MIDcounter

MIDcounter je certifikovaný měřič spotřeby energie, který umožňuje bezpečně a spolehlivě monitorovat spotřebu stanice během každého nabíjení.

Tento certifikovaný měřič **MID** zaznamenává všechny relevantní údaje o nabíjení a přenáší je ze stanice do systému Charge Point Management System (CPMS).



VAROVÁNÍ: Během tohoto kroku musí stanice být odpojená od rozvodu.

MIDcounter umístěte do téhož rozvodu jako stanice, za elektrickými chrániči.

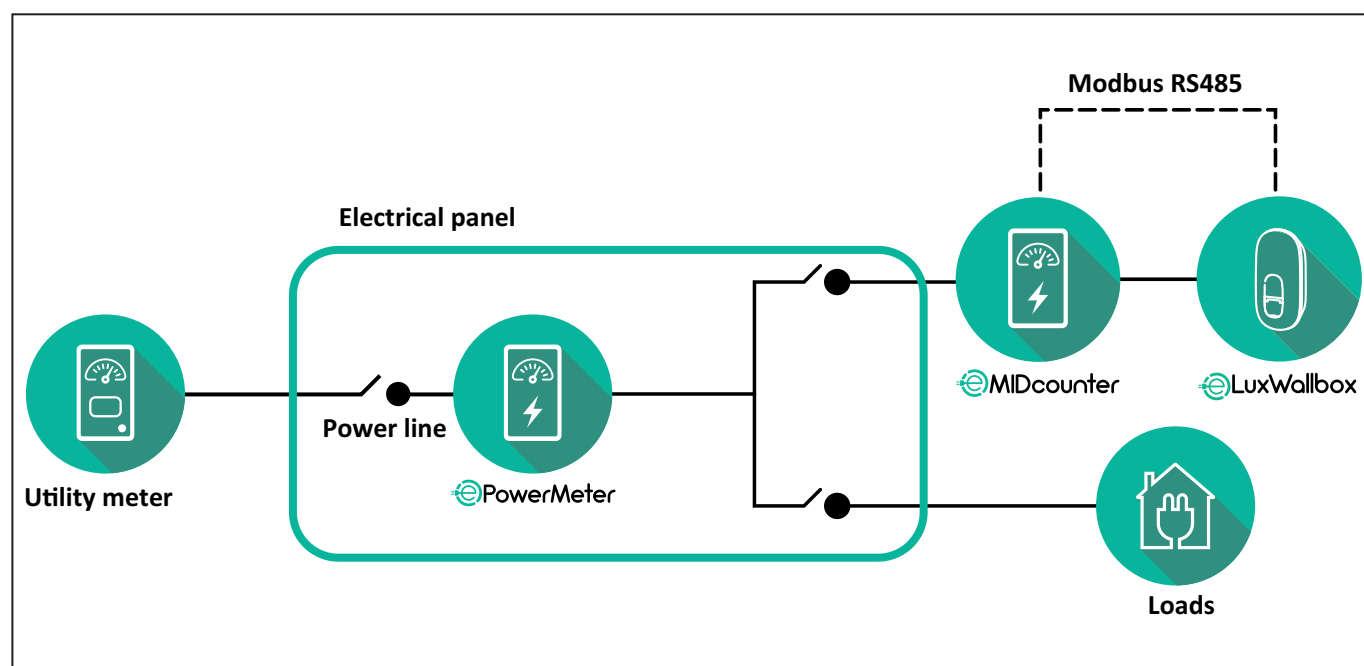

Na následujících schématech je vyobrazené zapojení měřiče **MIDcounter** (Finder a Gavazzi) do jednofázového a třífázového obvodu.

**Finder 1 f, přímé zapojení, 40 A
(7M2482300210)**

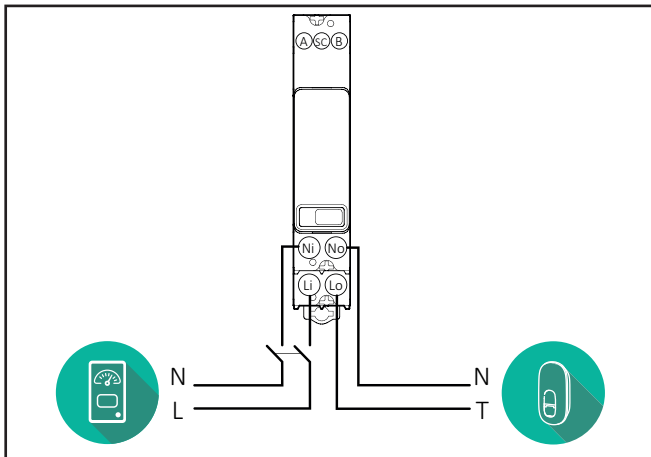

**Gavazzi 3 f, přímé zapojení, 65 A
(EM340DINAV23XS1PFB)**

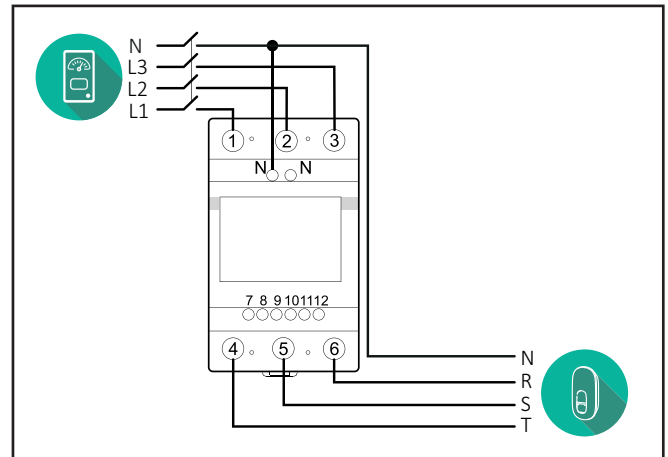

**Finder 3 f, přímé zapojení, 80 A
(7M3884000212)**

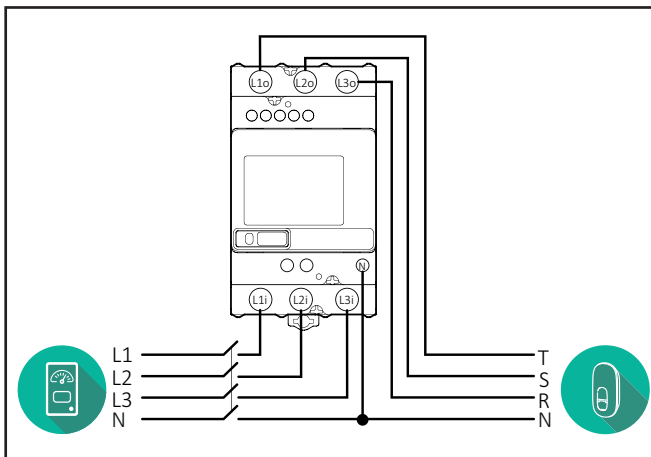

**Gavazzi 1 f, přímé zapojení, 100 A
(EM112DINAV01XS1PFB)**

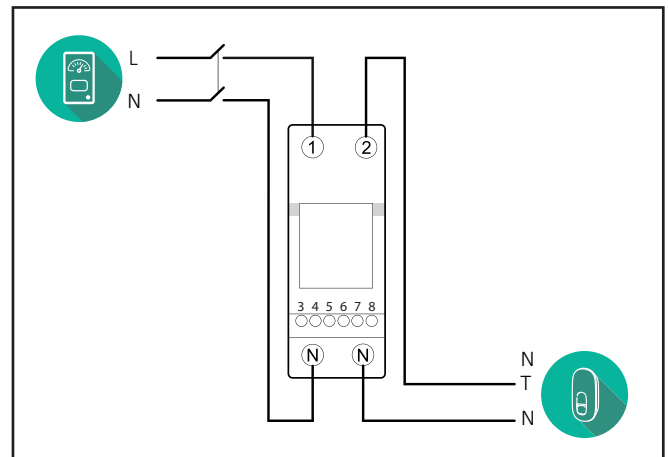

**Gavazzi 1 f, přímé zapojení, 32 A
(EM111DINAV81XS1PFB)**

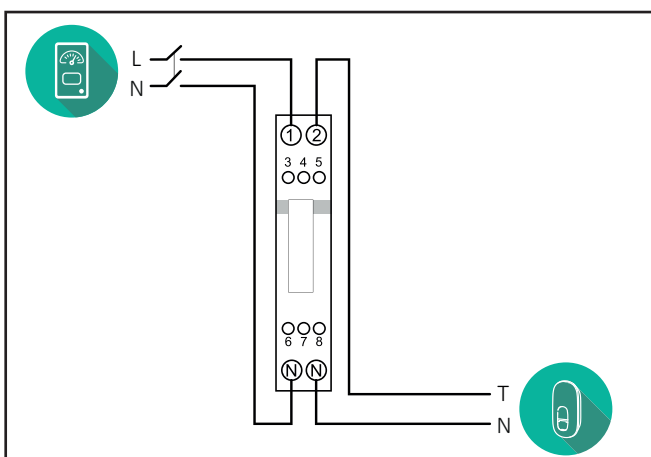

3.3. Instalace komunikačního kabelu

Komunikační kabel nainstalujte mezi elektroměr **PowerMeter (DPM)** a nabíjecí stanici **eLuxWallbox**.

- Na stanici **eLuxWallbox** odstraňte krytku ze vstupního bodu komunikačních kabelů a zasuňte článkový plášť Ø 25 mm.
- Utáhněte kabelovou koncovku.
- Vložte komunikační kabel tak, aby dosáhl ke komunikačnímu portu CN12 a navíc zůstala určitá vůle.
- Připojte komunikační kabel Modbus RS485 k pinům uzemnění, - a + konektoru CN12.



POZNÁMKA: Dvě kabelové vývodky lze nahradit kabelovými průchodkami Ø 25 mm (nejsou součástí dodávky stanice).

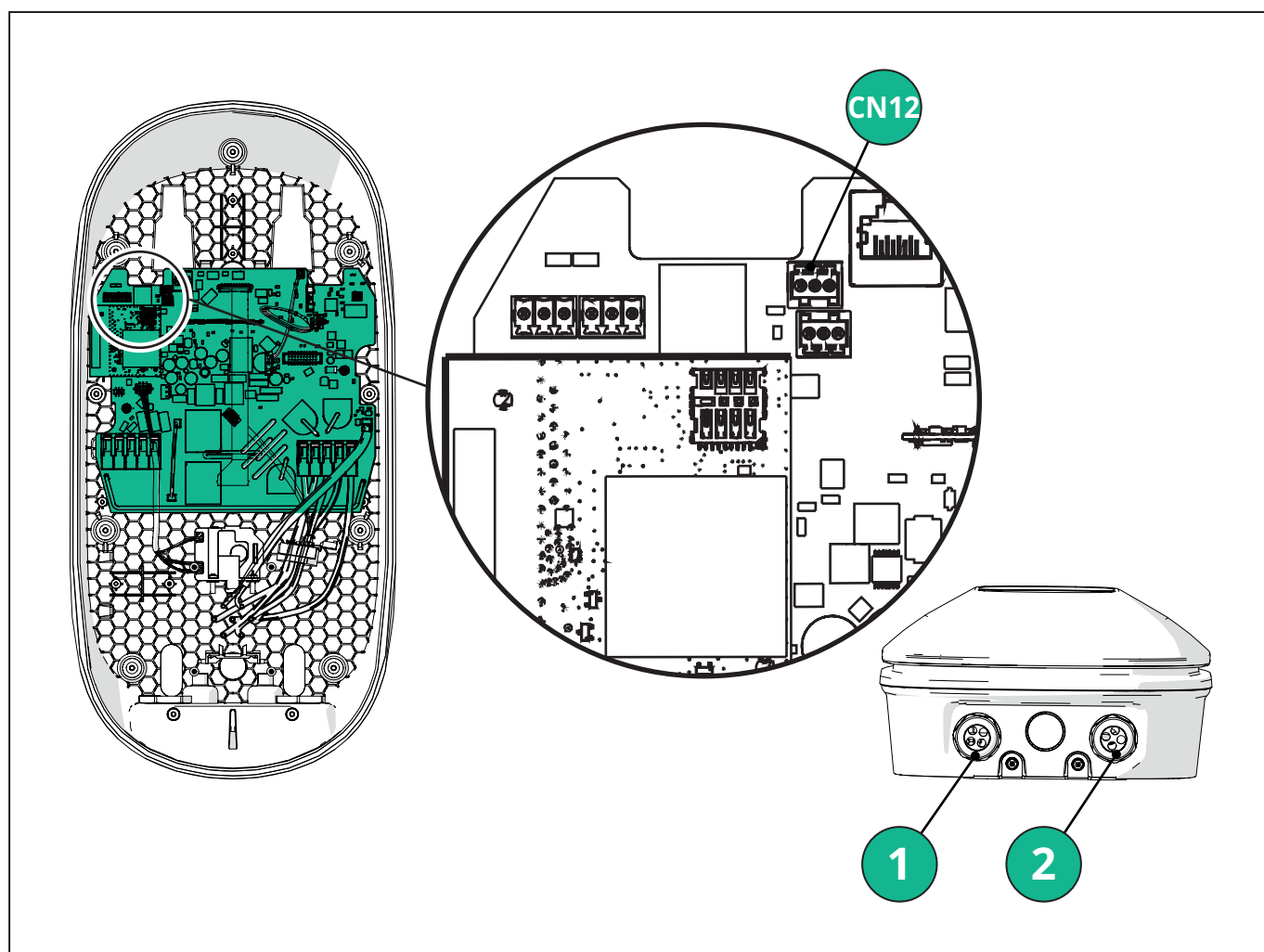

1 - Napájecí kabely

2 - Komunikační kabely

CN12 - RS485 Modbus pro externí komunikaci s měřičem (**DPM** a **MID**)

Připojte v následujícím pořadí komunikační kabely od elektroměru **PowerMeter (DPM)** do nabíjecí stanice **eLuxWallbox**.



VAROVÁNÍ: Pokud se instalují obě příslušenství, postupujte podle: „Kombinovaná instalace měřičů **MIDcounter** a **PowerMeter (DPM)**“.

CN12	Finder 1 f 7M.24.8.230.0210
Uzemnění	SC
-	B
+	A

CN12	Gavazzi 3 f EM340DINAV23XS1PFB
Uzemnění	10
-	9
+	8

Propojka 9/7

CN12	Finder 3 f 7M.38.8.400.0212
Uzemnění	SC
-	B
+	A

CN12	Gavazzi nepř 1 f EM111DINAV51XS1X / EM111DINMV51XS1X
Uzemnění	7
-	8
+	6

Propojka 8/5

CN12	Gavazzi 1 f EM111DINAV81XS1PFB
Uzemnění	7
-	8
+	6

Propojka 8/5

CN12	Gavazzi nepř 3 f EM330DINAV53HS1X
Uzemnění	13
-	12
+	11

Propojka 12/10

3.4. Kombinovaná instalace měřičů MIDcounter a PowerMeter (DPM)

Při instalaci obou elektrických příslušenství je umístění měřičů **MIDcounter** a **PowerMeter (DPM)** uvedené na níže uvedeném schématu:

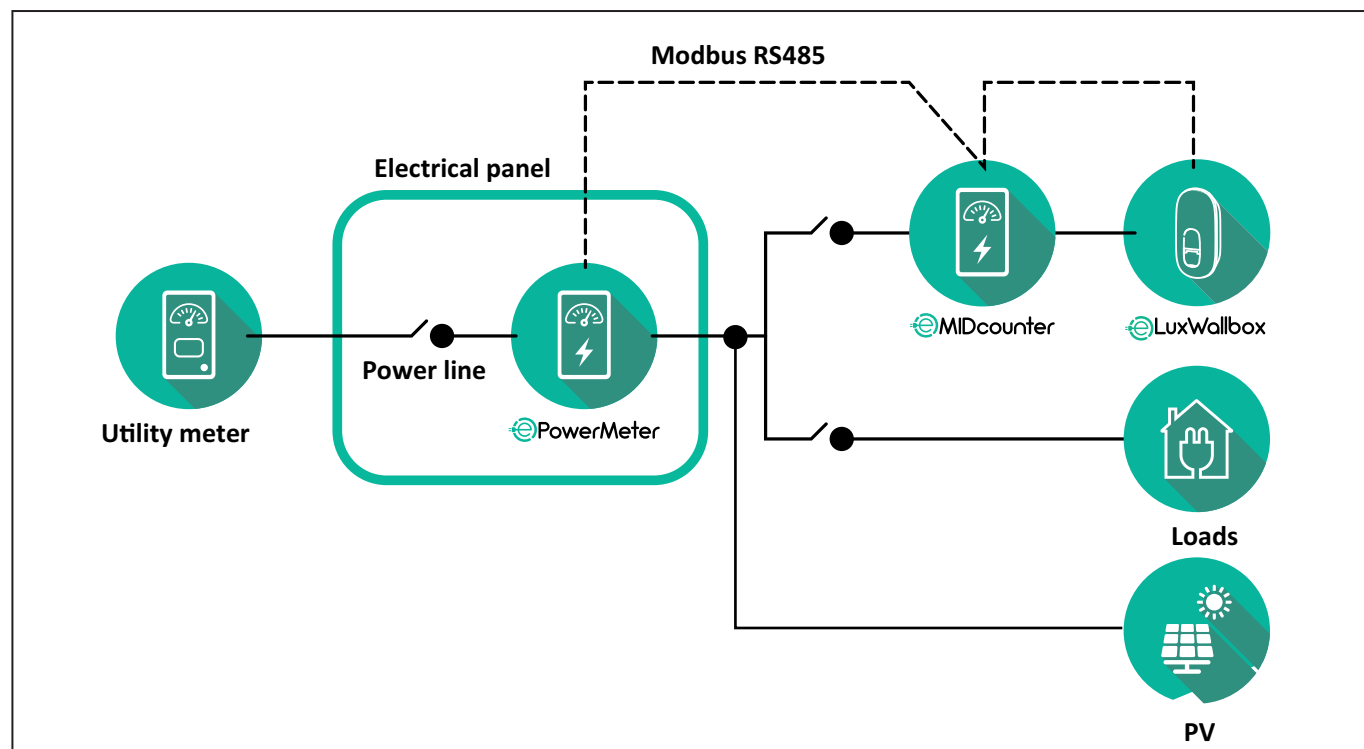

Připojte komunikační kabely Modbus. **PowerMeter (DPM)**, **MIDcounter** a **eLuxWallbox** je nutno připojit do stejné komunikační sběrnice ve formátu Daisy chain.

Na stanici **eLuxWallbox**:

- Odstraňte krytku ze vstupního bodu komunikačního kabelu a zasuňte člankový plášť Ø 25 mm.
- Utáhněte kabelovou koncovku.
- Vložte komunikační kabel tak, aby dosáhl ke komunikačnímu portu CN12 a navíc zůstala určitá vůle.
- Připojte komunikační kabel Modbus RS485 k pinům uzemnění, - a + konektoru CN12.

Komunikační kabely od příslušenství do nabíjecí stanice **eLuxWallbox** připojte podle následující tabulky.

Jedna fáze.

PowerMeter (DPM)	MIDcounter	eLuxWallbox
EM111DINAV51XS1X - EM111DINMV51XS1X	EM111DINAV81XS1PFB	CN12
GND (7)	GND (7)	GND
A- (8) / T*(5)	A- (8)	-
B+ (6)	B+ (6)	+
EM111DINAV51XS1X - EM111DINMV51XS1X	7M 24.8.230.0210	CN12
GND (7)	SC	GND
A-(8) / T*(5)	B-	-
B+ (6)	A+	+
EM111DINAV81XS1PFB	EM111DINAV81XS1PFB	CN12
GND (7)	GND (7)	GND
A-(8) / T*(5)	A- (8)	-
B+ (6)	B+ (6)	+
EM111DINAV81XS1PFB	7M 24.8.230.0210	CN12
GND (7)	SC	GND
A-(8) / T*(5)	B-	-
B+ (6)	A+	+
7M 24.8.230.0210	EM111DINAV81XS1PFB	CN12
SC	GND (7)	GND
B-	A- (8)	-
A+	B+ (6)	+
7M 24.8.230.0210	7M 24.8.230.0210	CN12
SC	SC	GND
B-	B-	-
A+	A+	+

Troj fáze.

PowerMeter (DPM)	MIDcounter	eLuxWallbox
EM330DINAV53HS1X	EM340DINAV23XS1PFB	CN12
GND (13)	GND (10)	GND
A-(12) / T*(10)	A-(9)	-
B+ (11)	B+ (8)	+
EM330DINAV53HS1X	7M.38.8.400.0212	CN12
GND (13)	SC	GND
A-(12) / T*(10)	B-	-
B+ (11)	A+	+
EM340DINAV23XS1PFB	EM340DINAV23XS1PFB	CN12
GND (10)	GND (10)	GND
A-(9) / T*(7)	A-(9)	-
B+ (8)	B+ (8)	+
EM340DINAV23XS1PFB	7M.38.8.400.0212	CN12
GND (10)	SC	GND
A-(9) / T*(7)	B-	-
B+ (8)	A+	+
7M.38.8.400.0212	EM340DINAV23XS1PFB	CN12
SC	GND (10)	GND
B-	A-(9)	-
A+	B+ (8)	+
7M.38.8.400.0212	7M.38.8.400.0212	CN12
SC	SC	GND
B-	B-	-
A+	A+	+

*A Na koncovku řetězce Modbus A na stanici je nutné nainstalovat koncový odpor 120 Ω. Nabíjecí stanice **eLuxWallbox** se dodává s nainstalovaným odporem. V modelech Gavazzi je odpor zabudovaný a lze ho zprovoznit propojkou mezi těmito koncovkami.

4. Konfigurace měřičů PowerMeter (DPM) a MIDcounter

Po nainstalování elektrického a komunikačního rozvodu zapněte **PowerMeter (DPM)** a/ nebo **MIDcounter**. Pak pokračujte konfigurací na displeji měřičů.

Konfigurace se liší v závislosti na modelu.

4.1. Modely Finder

Postup pro nastavení elektroměru Finder:

- Postupným tisknutím tlačítka na dotykovém displeji (a, b) lze přecházet mezi nabídkami a parametry.
- Dlouhým stiskem (~ 2 sekund) tlačítka na dotykovém displeji (a, b) zadejte a potvrďte volbu.

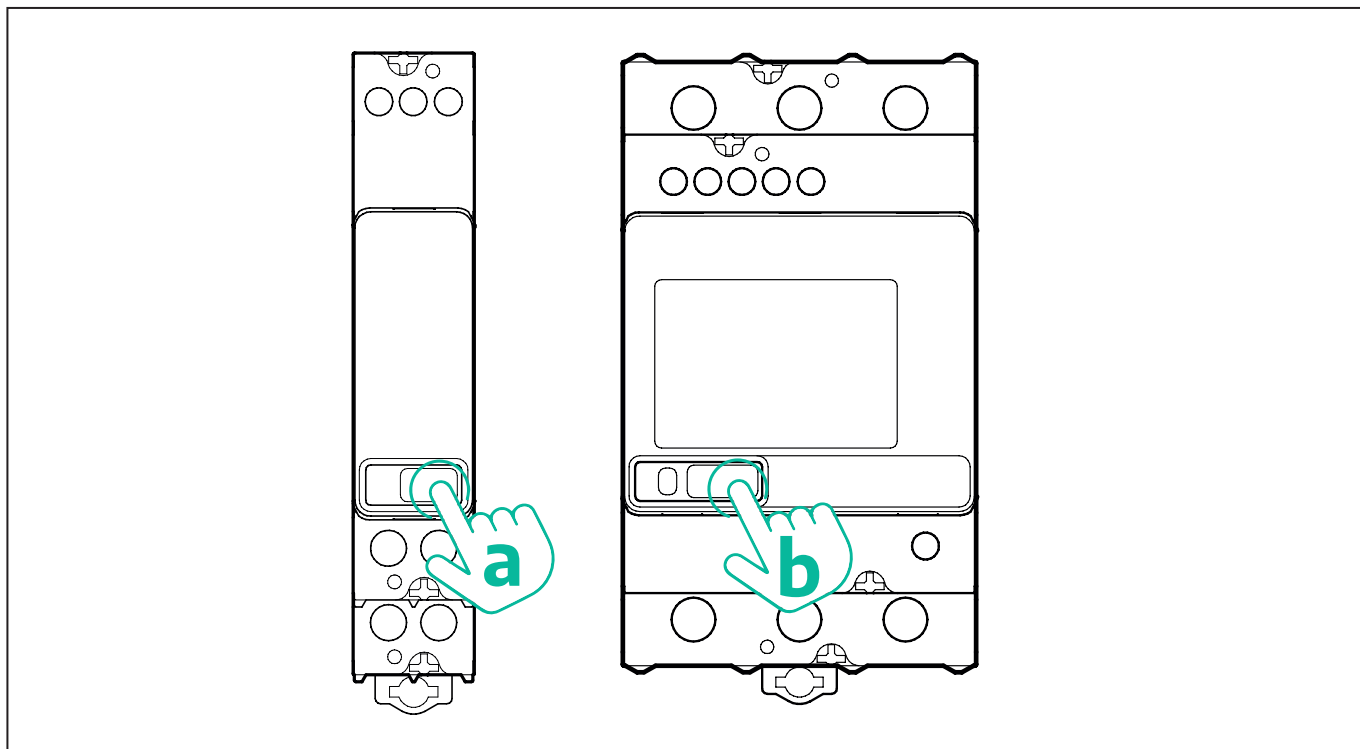

Pro nakonfigurování měřičů energie Finder v jednofázovém nebo třífázovém rozvodu postupujte takto:

- Při prvním zapnutí měřiče energie tiskněte tlačítko na dotykovém displeji (a, b), dokud se nerozblíká text na displeji pro vstup do menu „MAIN“.
- Stiskněte na dotykovém displeji tlačítko (a, b) pro procházení menu „MAIN“ a vyberte možnost „SETTING“ („SET“ u jednofázového měřiče). Zadejte volbu dlouhým stiskem.
- Přejděte do menu „SETTING“ stiskem tlačítka na dotykovém displeji (a, b) a vyberte možnost „COMMUNICATION“ („COMM“ na jednofázovém měřiči). Zadejte volbu dlouhým stiskem.
- Vložte správné hodnoty uvedené v tabulce níže. Pro změnu hodnoty tiskněte tlačítko na dotykovém displeji (a, b) a potvrďte zadání dlouhým stiskem tlačítka.

Pouze třífázový elektroměr Finder (navíc k předchozím nastavením):

- Stiskněte dlouze tlačítko na dotykovém displeji (a, b), dokud se nerozblíká text na displeji pro vstup do menu „MAIN“ (nebo pro návrat na menu „MAIN“).
- Procházejte menu „MAIN“ tisknutím tlačítka na dotykovém displeji (a, b), pak vyberte „INSTALLATION“. Dlouhým stiskem tlačítka (a, b) na dotykovém displeji zadejte volbu.
- Přejděte do menu „INSTALLATION“ stiskem tlačítka na dotykovém displeji (a, b) a vyberte následující možnost:
 - „Communication mode“ = „3L+N, L+N-Arithmetic“
 - Po potvrzení správné volby zadejte heslo: „**DCBA**“ Pozor: po zadání hesla **DCBA** již nelze změnit konfiguraci.
 - Na výzvu potvrďte změnu zvolením „Yes“.

VŠECHNY MODELY ZNAČKY FINDER	PowerMeter (DPM)	MIDcounter
ADRESA ZAŘÍZENÍ	1	2
BITY ZA SEKUNDU (BAUD)	38400 bit/s	38400 bit/s
PARITA	Kladná	Kladná
STOP BIT	1	1
Další pro třífázový typ	PowerMeter (DPM)	MIDcounter
KOMUNIKAČNÍ REŽIM	3L+N, L+N - Aritmetický	3L+N, L+N - Aritmetický
HESLO	DCBA	DCBA

4.2. Modely Gavazzi

Nastavení měřiče energie Gavazzi:

- Mezi nabídkami a parametry lze přecházet postupným tisknutím tlačítka na dotykovém displeji (c, d, e, g).
- Stiskněte tlačítko (~ 2 sekund) na dotykovém displeji (d, f) pro vstup do menu a potvrzení volby.

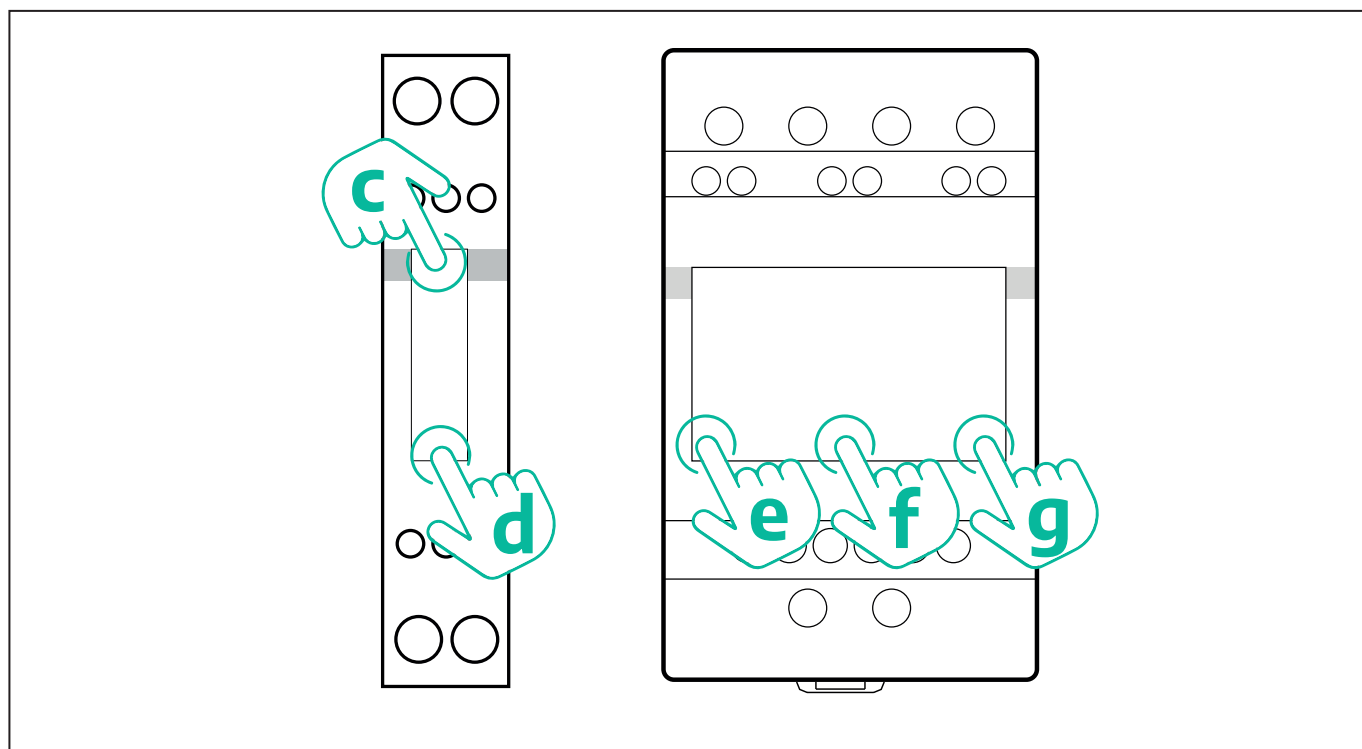

Pro nakonfigurování měřičů energie Gavazzi v jednofázovém přímém a nepřímém rozvodu postupujte takto:

- Při prvním zapnutí měřiče energie tiskněte tlačítko na dotykovém displeji (d), dokud se na displeji nezobrazí heslo.
- Dlouhým současným stiskem tlačítek (c, d) potvrďte heslo „0000“ a vstupte do menu „MAIN“.
- Procházejte menu „MAIN“ stiskem horního tlačítka (c) a vyberte níže v tabulce následující možnosti:

Pro nakonfigurování měřičů energie Gavazzi ve třífázovém přímém a nepřímém rozvodu postupujte takto:

- Při prvním zapnutí měřiče energie stiskněte dlouze prostřední tlačítko (f), dokud se na displeji nezobrazí heslo.
- Dlouhým současným stiskem tlačítek (e, g) potvrďte heslo „0000“ a vstupte do menu „MAIN“.
- Procházejte menu „MAIN“ tisknutím tlačítek (e nebo g) a vyberte níže v tabulce následující možnosti:

VŠECHNY MODELY ZNAČKY GAVAZZI	PowerMeter (DPM)	MIDcounter
PRŮCHOD	0000	0000
ADRESA	001	002
BAUD	38,4	38,4
PARITA	Kladná	Kladná
Další pro třífázový typ		
SYSTÉM	3Pn	3Pn
ADRESA	001	002

4.3. Přehled konfigurace zařízení

EM340DINAV23XS1PFB / EM330DINAV53HS1X	
PRŮCHOD	0000
SYSTÉM	3Pn
ADRESA	1
BAUD	38,4
PARITA	KLADNÁ

EM340DINAV23XS1PFB	
PRŮCHOD	0000
SYSTÉM	3Pn
ADRESA	2
BAUD	38,4
PARITA	KLADNÁ

EM111DINAV81XS1PFB / EM111DINAV51XS1X / EM111DINMV51XS1X	
PRŮCHOD	0000
ADRESA	001
BAUD	38,4
PARITA	KLADNÁ

EM111DINAV81XS1PFB	
PRŮCHOD	0000
ADRESA	002
BAUD	38,4
PARITA	KLADNÁ

7M 24.8.230.0210	
ADRESA ZAŘÍZENÍ	_ _ 1
BITY ZA SEKUNDU (BAUD)	38400 bit/s
PARITA	KLADNÁ
STOP BIT	1

7M 24.8.230.0210	
ADRESA ZAŘÍZENÍ	_ _ 2
BITY ZA SEKUNDU (BAUD)	38400 bit/s
PARITA	KLADNÁ
STOP BIT	1

7M.38.8.400.0212	
ADRESA ZAŘÍZENÍ	_ _ 1
BITY ZA SEKUNDU (BAUD)	38400 bit/s
PARITA	KLADNÁ
STOP BIT	1
REŽIM PŘIPOJENÍ	3L+N, L+N - Aritmetický
HESLO	DCBA

7M.38.8.400.0212	
ADRESA ZAŘÍZENÍ	_ _ 2
BITY ZA SEKUNDU (BAUD)	38400 bit/s
PARITA	KLADNÁ
STOP BIT	1
REŽIM PŘIPOJENÍ	3L+N, L+N - Aritmetický
HESLO	DCBA

4.4. PowerMeter (DPM) a MIDcounter: konfigurace v aplikaci

Instalaci a konfiguraci stanice **eLuxWallbox** a jejích příslušenství je nutno dokončit v příslušné aplikaci.

PowerUp je aplikace pro chytré telefony vyhrazená pouze pro kvalifikované techniky. Lze ji stáhnout z obchodu Google Play™ a Apple Store®. Konfigurace se provádí přes Bluetooth. Bez nakonfigurování v aplikaci nebude nabíjecí stanice fungovat správně.



UPOZORNĚNÍ: Ujistěte se, že máte nejnovější verzi aplikace PowerUp, abyste měli přístup ke všem funkcím.

Postupujte podle níže uvedených pokynů, abyste mohli začít s aplikací:

Stáhněte a nainstalujte si aplikaci PowerUp do chytrého telefonu a zapněte v něm Bluetooth.



Sejmutím QR kódu stanice **eLuxWallbox** ji spárujete s aplikací. QR kód je uvedený na boku spotřebiče.



Po spárování dokončete konfiguraci stanice **eLuxWallbox** a jejího příslušenství kliknutím na parametr k nakonfigurování.

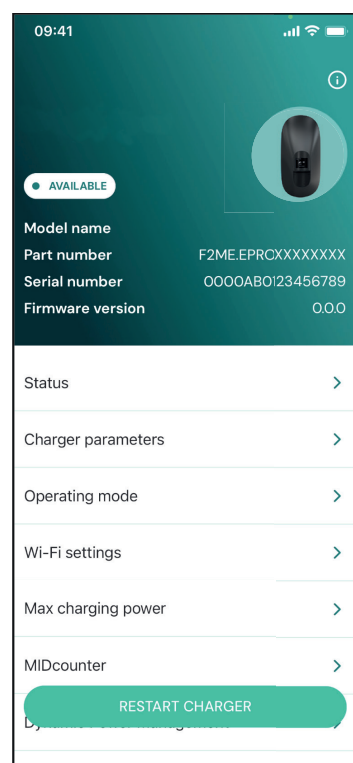

4.5. Konfigurace elektroměru PowerMeter (DPM)

Pro dokončení instalace elektroměru **PowerMeter (DPM)** postupujte takto:

Zvolte **DPM PowerMeter** na domovské stránce.

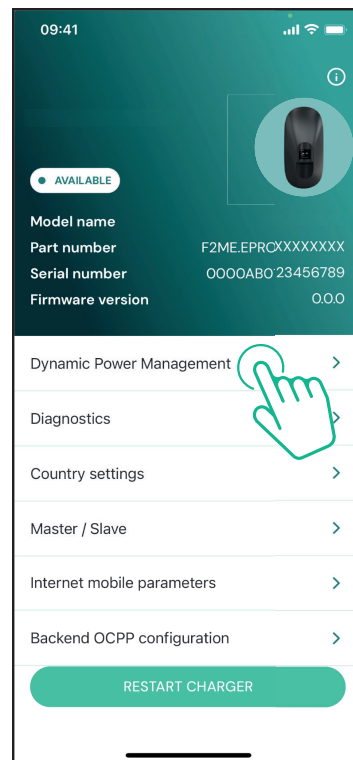

V rozbalovacím menu zvolte typ elektroměru **PowerMeter** podle nainstalovaného modelu.

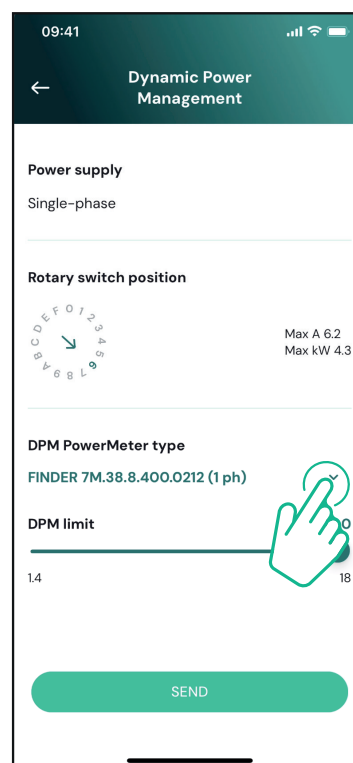

Zadejte hodnotu podle uživatelské smlouvy jak mezní hodnotu výkonu pro **DPM**.

Pouze u měřiče s nepřímým zapojením: nastavte kurzorem transformační poměr proudu CT.

- Pro CTV 60 A nastavte 60 jako poměr proudu
- Pro CTA 100 A nastavte 20 jako poměr proudu
- Pro CTA 150 A nastavte 30 jako poměr proudu

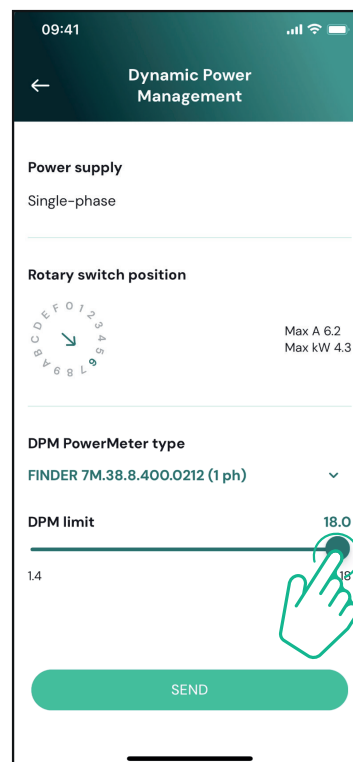

Klikněte v překryvném okně na „Send“: **eLuxWallbox** se restartuje.

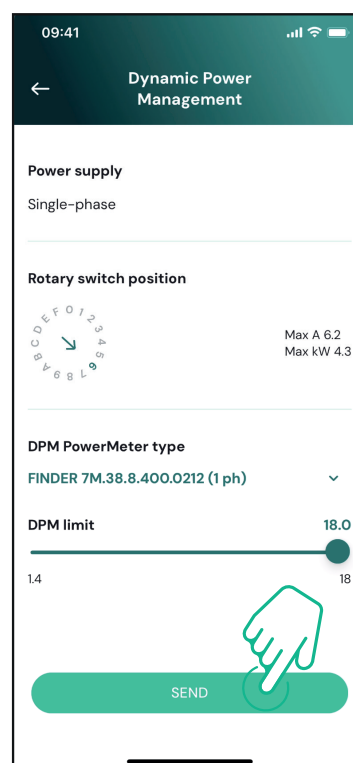

4.6. Konfigurace přístroje MIDcounter

Postup pro dokončení instalace měřiče **MIDcounter**:

Zvolte **MIDcounter** na domovské stránce.

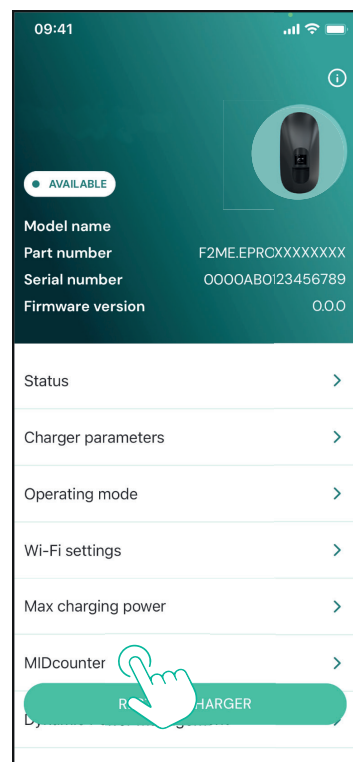

V rozbalovacím menu zvolte typ měřiče **MIDcounter** podle nainstalovaného modelu.

V rozbalovacím menu zvolte „OFF“ pro vypnutí konfigurace měřiče **MIDcounter**.

Potvrďte kliknutím na „Send“.

Aby se změny projevily, klikněte na šipku zpět v levém horním rohu a restartujte stanici **eLuxWallbox** příslušným tlačítkem na domovské stránce.

Pokud instalace obsahuje **PowerMeter (DPM)** i **MIDcounter**, je možné pokračovat konfigurací **DPM** ještě před tímto restartem.

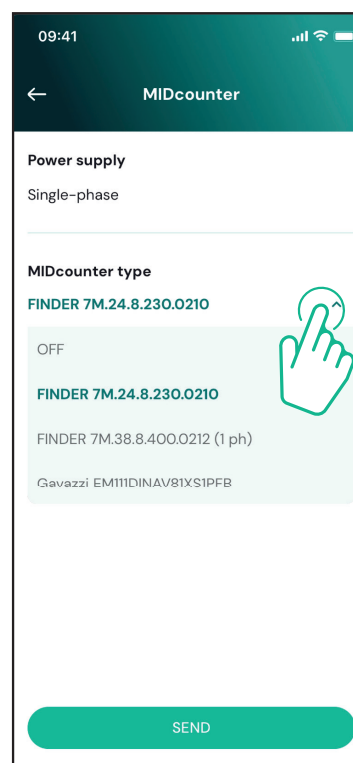

5. ŘEŠENÍ PROBLÉMŮ

Chybové stavy se uloží do diagnostických protokolů a zobrazí se na panelu stanice:

- U modelu **eLuxWallbox** Move bliká ledkový pásek červeně. Zjistěte v sekci **Diagnostika** v aplikaci PowerUP nebo v aplikaci koncového uživatele, o jaký chybový kód se jedná.
- U modelu **eLuxWallbox** se na displeji zobrazí stejný chybový kód jako v sekci **Diagnostika** v aplikaci PowerUP.

Pokud dojde k chybě, nabíjení se přeruší a zásuvka se odemkne, aby bylo možné vytáhnout vidlici.

V následující tabulce je uvedený seznam chyb, které se mohou vyskytnout, a příslušné řešení. Pokud chyba přetrvává, zaznamenejte si sériové číslo uvedené na štítku stanice a kontaktujte služby zákazníků.

Kód chyby / problém	"Popis chyby"	Řešení problémů
100	Výpadek napájení	<p>Zkontrolujte, zda je jistič v poloze ON. Zkontrolujte, je kabeláž správně připojená k CN1. Zkontrolujte napětí na CN1.</p> <p>Odpojte kabel Typ 2, počkejte, až teplota klesne. Pak chyba sama zmizí.</p>
101	Přehřátí	<p>Pro restart nabíjení připojte znovu kabel. Ujistěte se, že je místo zvolené pro instalaci stanice kompatibilní se předepsaným teplotním rozsahem (-25/+50 °C, bez vystavení přímému slunečnímu svitu).</p>
102	Chyba komunikace mezi MCU a MPU.	<p>Restartujte stanici jističem, pak ji nechte vypnutou po dobu min. 60 sekund. Zkontrolujte kabeláž na CN1.</p>
103	Hardwarová chyba, chyba zařízení na ochranu proti zemního spojení (GPD error)	<p>- u jednofázového připojení se ujistěte, že je zemnicí vodič je připojený k PE, nulový vodič k N a fázový vodič k T - u třífázového připojení se ujistěte, že je zemnicí vodič připojený k PE, nulový vodič k N a fázové vodiče L1, L2 a L3 k T, S a R.</p> <p>Zkontrolujte, zda mezi PE a N není rozdíl napětí vyšší než 10 V. Zkontrolujte zapojení chrániče PE.</p> <p>Pokud jsou přípoje v pořádku a chyba trvá, zapněte stanici a upravte konfiguraci konektoru Dipswitch (SW2).</p>

104	Hardwarová chyba, monitor zbytkového proudu AC v poruše. (spoušť RCM AC)	<p>Zkuste znovu zapnout nabíjení odpojením a zapojením všech konektorů.</p> <p>Pokud problém trvá, zkontrolujte nabíjecí kabel nebo přívod do vozidla na případné další problémy.</p> <p>Pokud není problém s kabely a EV, zkontrolujte konektor CN27 a kabel RCM.</p>
105	Hardwarová chyba, monitor zbytkového proudu DC v poruše. (spoušť RCM DC)	<p>Zkontrolujte, zda není problém s kabelem nebo vozidlem. Pokud možno zkuste spustit nabíjení jiným kabelem nebo vozidlem.</p>
106	Vnitřní chyba měřiče	<p>Restartujte stanici jističem, pak ji nechte vypnutou po dobu min. 60 sekund.</p>
107	Chyba komunikace s PowerMeter (DPM)	<p>Zkontrolujte, zda je správně nakonfigurovaná komunikace v elektroměru DPM PowerMeter.</p> <p>Zkontrolujte, zda je v instalační aplikaci správně nakonfigurovaný model DPM.</p> <p>Zkontrolujte připojení komunikačního kabelu na CN12.</p> <p>Zkontrolujte, zda byl pro Modbus RS485 použitý správný kabel a ve správné délce.</p>
108	Chyba konfigurace, Poloha otočného přepínače (typ napájení) není v souladu s typem DPM/MID .	<p>Zkontrolujte polohu otočného přepínače. Pokud není v souladu s 1f/3f instalací, změňte ji podle tabulky uvedené v manuálu, pak restartujte stanici.</p> <p>Pokud není příslušenství nainstalované (DPM/MID), zkontrolujte, že je funkce vypnutá v instalační aplikaci.</p> <p>Pokud není příslušenství nainstalované (DPM/MID), zkontrolujte, zda je v instalační aplikaci nastavený správný model. Pak restartujte stanici.</p>
109	Main/secondary RS485: chyba komunikace	<p>Zkontrolujte konfiguraci nastavení Main / Secondary v instalační aplikaci.</p> <p>Zkontrolujte, zda je hlavní stanice dostupná.</p> <p>Zkontrolujte připojení komunikačního kabelu na CN9 a CN10.</p> <p>Zkontrolujte, zda byl pro Modbus RS485 použitý správný kabel.</p>

110	MIDcounter: chyba komunikace	<p>Zkontrolujte v zařízení MIDcounter na správnou konfiguraci komunikace.</p> <p>Zkontrolujte připojení komunikačního kabelu na CN12.</p> <p>Zkontrolujte, zda byl pro Modbus RS485 použitý správný kabel.</p> <p>Zkontrolujte, zda je v instalační aplikaci správně nakonfigurovaný model MID.</p>
300	Nesoulad mezi ovládním stykače stanice a zpětnou vazbou.	<p>Restartujte stanici jističem, pak ji nechte vypnutou po dobu min. 60 sekund.</p> <p>Pokud chyba trvá i po restartu, obraťte se na zákaznický servis.</p>
301	Byl detekován zkrat ve vedení Control Pilot.	<p>Při vypnuté stanici zkontrolujte zásuvku na vnitřní či vnější poškození nebo závadu (pokud ano, nepoužívejte stanici a kontaktujte zákaznický servis).</p> <p>Zkontrolujte, zda problém není v kabelu ani u vozidla, a pokuste se o další nabíjení (s jiným vozidlem či jiným kabelem, pokud je to možné).</p>
302	Stav E nebo F nastavený pro vedení Control Pilot.	Při vypnuté stanici zkontrolujte kabel a jeho přípojky na poškození či závady uvnitř a vně (pokud ano, nepoužijte je a pokuste se nabít vozidlo jiným kabelem).
303	Odpojený Control Pilot.	Zkontrolujte, zda jsou konektory kabelu řádně zasunuté do zásuvky stanice a vozidla.
304	Odpojený Proximity Pilot.	Zkontrolujte, zda problém není v kabelu ani u vozidla, a pokuste se o další nabíjení (s jiným vozidlem či jiným kabelem, pokud je to možné).
305	Byl detekován prasklý Proximity Pilot.	Zkontrolujte, zda problém není v kabelu ani u vozidla, a pokuste se o další nabíjení (s jiným vozidlem či jiným kabelem, pokud je to možné).
306	Byla detekovaná vadná dioda ve vedení Control Pilot (no - 12V).	Odpojte kabel od stanice a vozidla a opětným připojením zkuste, zda se nabíjení spustí.
307	Odpojený Control Pilot.	<p>Při vypnuté stanici zkontrolujte kabel a jeho přípojky na poškození či závady uvnitř a vně (pokud ano, nepoužijte je a pokuste se nabít vozidlo jiným kabelem).</p> <p>Zkontrolujte, zda jsou konektory kabelu řádně zasunuté do zásuvky stanice a vozidla.</p> <p>Zkontrolujte, zda problém není v kabelu ani u vozidla, a pokuste se o další nabíjení (s jiným vozidlem či jiným kabelem, pokud je to možné).</p>

308	Nesoulad mezi ovládáním motoru a zpětnou vazbou nebo motor v poruše.	Odpojte kabel od stanice a vozidla a opětným připojením zkuste, zda se nabíjení spustí. Zkontrolujte, zda jsou konektory kabelu řádně zasunuté do zásuvky stanice a vozidla.
309	Chyba při kontrole motoru během inicializační fáze EVSE.	Restartujte stanici jističem, pak ji nechte vypnutou po dobu min. 60 sekund.
310	Byla detekována chyba před nabíjením (nedošlo k detekci PP nebo chyba motoru nebo nedošlo k detekci CP).	Při vypnuté stanici zkontrolujte kabel a jeho přípojky na poškození či závady uvnitř a vně (pokud ano, nepoužijte je a pokuste se nabít vozidlo jiným kabelem). Zkontrolujte, zda jsou konektory kabelu řádně zasunuté do zásuvky stanice a vozidla.
311	Byla detekována chyba po nabíjení (porucha motoru nebo neodpojení CP).	Zkontrolujte, zda problém není v kabelu ani u vozidla, a pokuste se o další nabíjení (s jiným vozidlem či jiným kabelem, pokud je to možné). Restartujte stanici jističem, pak ji nechte vypnutou po dobu min. 60 sekund.
312	Nouzový stop přijatý od MPU.	
313	Během nabíjení byl detekovaný ve vedení Control Pilot proud 100% střídou.	Zkontrolujte, zda není problém v kabelu ani vozidle, a pokuste se opět spustit nabíjení jiným kabelem a/nebo stanicí.
315	Proud mimo meze ve fázi L1	
316	Proud mimo meze ve fázi L2	Odpojte kabel, pokud možno snižte nabíjecí výkon na straně vozidla a pokuste se opět spustit nabíjení.
317	Proud mimo meze ve fázi L3	
318	Napětí pod mezní hodnotou u fáze L1	Zkontrolujte, zda je otočný spínač nastavený na polohu konzistentní s jednofázovou/třífázovou instalací. Zkontrolujte, zda je na CN1-T napětí vyšší než 196 V. Pokud je nižší než 196 V, zkontrolujte elektrický rozvod nebo kontaktujte dodavatele elektrické energie. Pokud se chyba vyskytne během nabíjení vozidla, snažte se snížit nastavený nabíjecí výkon. Zkontrolujte, zda je elektrický rozvod dimenzovaný na odběr výkonu vozidlem.

319	Napětí pod mezní hodnotou u fáze L2	Otočný přepínač je ve třífázové poloze. Zkontrolujte, zda se skutečně jedná o třífázovou instalaci. Pokud ne, přepněte otočný přepínač do správné polohy pod instalačního manuálu.
320	Napětí pod mezní hodnotou u fáze L3	Zkontrolujte, zda je na CN1-S a R napětí vyšší než 196 V. Pokud je nižší než 196 V, zkontrolujte elektrický rozvod nebo kontaktujte dodavatele elektrické energie. Pokud se chyba vyskytne během nabíjení vozidla, snažte se snížit nastavený nabíjecí výkon. Zkontrolujte, zda je elektrický rozvod dimenzovaný na odběr výkonu vozidlem.
321	Zakázaná změna stavu (IEC 61851-1)	EV nesplňuje standardy IEC 61851-1 stanovené pro nabíjení. Odpojte kabel od stanice a vozidla a opětným připojením zkuste, zda se nabíjení spustí. Pokud chyba trvá, obraťte se na výrobce vozidla.
	Displej/kontrolky zablokované v uvítacím režimu Welcome mode (kontrolky blikají červeně-zeleně-modře) Kontrolky či displej se nerozsvítí při zapnutí	Restartujte stanici jističem, pak ji nechte vypnutou po dobu min. 60 sekund.
	Stanice se nezapne.	Restartujte stanici: to může trvat až 30 sekund. Zkontrolujte, zda je jistič v poloze ON. Zkontrolujte, je kabeláž správně připojená k CN1. Zkontrolujte napětí na CN1. Restartujte stanici jističem, pak ji nechte vypnutou po dobu min. 60 sekund.
	Kabel uvízl v zásuvce stanice	Vypněte stanici jističem a vypojte kabel

Nabíjení se přerušilo a na displeji svítí zelená kontrolka/hláška. Nabíjení přerušil **DPM** nebo EV. Lze pokračovat v nabíjení.

Zkontrolujte, zda mezní hodnota nastavená v instalační aplikaci pro elektroměr **DPM** odpovídá smluvní hodnotě v kW uvedené ve smlouvě uživatele o dodávce elektrické energie. Pokud je hodnota správná, počkejte, až se nabíjení znovu spustí, nebo vypněte některý spotřebič v domácnosti.

V případě třífázové instalace zkontrolujte rozložení elektrických zátěží v jednotlivých fázích domácího rozvodu.

Po sejmutí QR kódu se dokončilo spárování.

Zkontrolujte, zda není porušený QR kód na štítku.

Aktualizuje aplikaci na nejnovější verzi.

Zavřete aplikaci a zkuste to znovu.

Restartujte stanici jističem, pak ji nechte vypnutou po dobu min. 60 sekund.

6. ČISTĚNÍ

Doporučuje se očistit vnějšek stanice, kdykoli je to třeba. Použijte měkkou utěrku navlhčenou neutrálním čisticím prostředkem. Po očištění odstraňte všechny stopy po vlhkosti nebo kapalině měkkou suchou utěrkou.



VÝSTRAHA: Stanici nečistěte tlakovým vzduchem ani proudem vody. Nepoužívejte mycí prostředky, které jsou příliš agresivní a korozivní pro materiály, z nichž je nabíjecí stanice vyrobená.

7. LIKVIDACE OBALU



Obaly zlikvidujte způsobem šetrným k životnímu prostředí. Materiály použité k balení tohoto produktu lze recyklovat a musí být zlikvidovány v souladu s legislativou platnou v zemi použití. Na obalu jsou uvedené následující pokyny ohledně zpracování obalu jako odpadu:



POZNÁMKA: Další informace o zařízení pro zpracování odpadu lze zjistit u orgánů státní správy v daném místě.

8. PODPORA

Pokud máte dotazy ohledně instalace stanice **eLuxWallbox**. Ohledně všech ostatních informací nebo s žádostmi o podporu kontaktuje společnost Free2move eSolutions S.p.A. prostřednictvím příslušné sekce na jejích webových stránkách: www.esolutions.free2move.com.

9. ODMÍTNUTÍ ODPOVĚDNOSTI

Společnost Free2move eSolutions S.p.A. nenesou odpovědnost za žádné škody přímo či nepřímo způsobené osobám, na věcech nebo zvířatům nedodržením jakéhokoli pokynu uvedeného v tomto manuálu a varování týkajících se instalace a údržby zařízení **eLuxWallbox**.

Společnost Free2move eSolutions S.p.A. si vyhrazuje veškerá práva k tomuto dokumentu, textům a obrázkům, které obsahuje. Je zakázáno je rozmnožovat zcela nebo zčásti, zpřístupnit třetím osobám či používat jejich obsah bez předchozího písemného souladu společnosti Free2move eSolutions S.p.A.

Veškeré informace v této příručce mohou být změněny bez předchozího upozornění a nepředstavují pro výrobce žádný závazek. Obrázky v tomto návodu jsou pouze ilustrační a mohou se lišit od dodaného produktu.

EN

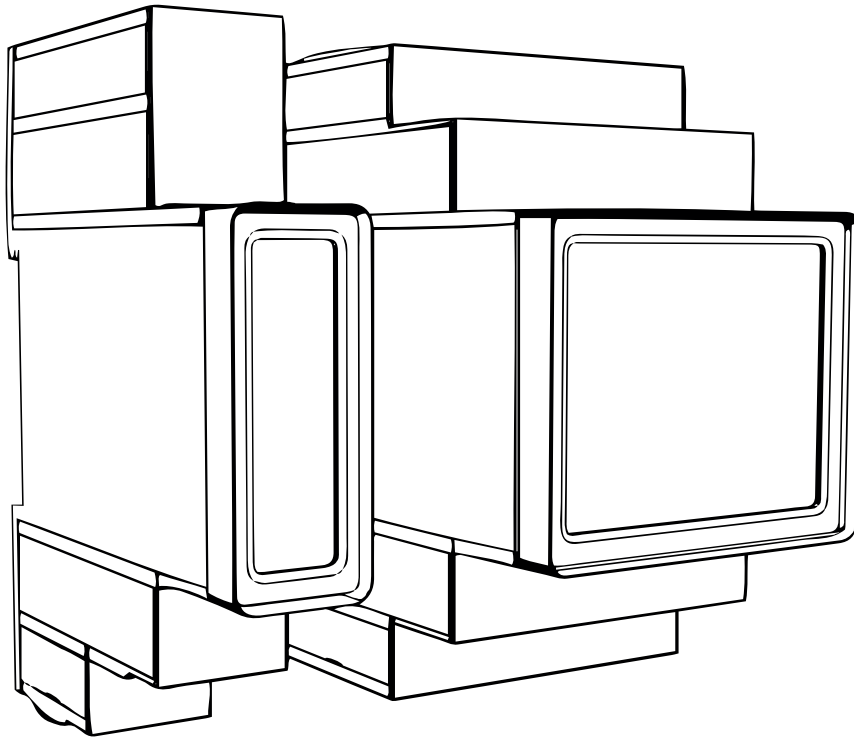
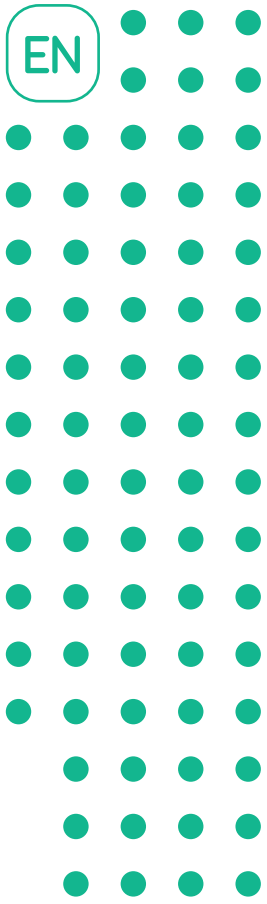

LuxWallbox

Accessories Manual



For safe and proper use,
follow these instructions.
Keep them for future reference

Table of content

1. INTRODUCTION	4
1.1. Purpose of the Manual	4
1.2. Identification of the Manufacturer.....	4
1.3. Structure of the Accessories Manual	4
1.4. Safety	5
1.5. Personal Protective Equipment (PPE).....	6
1.6. Warranty and delivery conditions	6
1.7. List of documents.....	7
1.8. Warnings	7
2. GENERAL INFORMATION	8
2.1. Fields of use	9
3. ACCESSORIES INSTALLATION	10
3.1. Installing PowerMeter (DPM).....	10
3.2. Installing MIDcounter	15
3.3. Communication cable installation	17
3.4. MIDcounter and PowerMeter (DPM) combined installation .	19
4. PowerMeter (DPM) and MIDcounter configuration.	22
4.1. Finder models.....	22
4.2. Gavazzi models.....	24
4.3. Device configuration summary	25
4.4. PowerMeter (DPM) and MIDcounter configuration on APP ..	26
4.5. PowerMeter (DPM) configuration	28
4.6. MIDcounter configuration.....	30
5. TROUBLESHOOTING.....	31
6. CLEANING.....	36
7. PACKAGING DISPOSAL	36
8. ASSISTANCE.....	37
9. DISCLAIMER.....	37



1. INTRODUCTION

1.1. Purpose of the Manual

This installation manual is a guide to help operators to work safely and carry out the installation operations needed to keep the charger in good working order.

The purpose of this document is to support qualified technicians who have received appropriate training, and demonstrated suitable skills and knowledge in the construction, installation, operation and maintenance of electrical equipment.

If the charger is used in a manner not specified in this manual, the protection provided by the charger may be impaired. This document contains the information required for the installation of the charger.

This document has been carefully checked by the Manufacturer Free2move eSolutions S.p.A. but oversights cannot be completely ruled out. If any errors are noted, please inform Free2move eSolutions S.p.A. Except for explicit contractual obligations, under no circumstances may Free2move eSolutions S.p.A. be held liable for any loss or damage resulting from the use of this manual, or from installation of the equipment. This document was originally written in English. In the event of any inconsistencies or doubts, please ask Free2move eSolutions S.p.A. for the original document.

1.2. Identification of the Manufacturer

The manufacturer of the charger is:

Free2move eSolutions S.p.A.

Piazzale Lodi, 3

20137 Milan – Italy

www.esolutions.free2move.com

1.3. Structure of the Accessories Manual





This manual is divided into chapters based on different topics and containing all the information that is needed to install the charger safely.

Each chapter is sub-divided into paragraphs which examine the fundamental points, and each paragraph may have its own title, along with sub-titles and a description.

1.4. Safety

This manual contains important safety instructions that must be followed during installation of the charger.

In order to fulfil this objective, this manual contains a number of precautionary texts, containing special instructions. These instructions are highlighted by a specific text box and are accompanied by a symbol, and are provided in order to ensure the safety of the personnel required to perform the operations described, and to avoid any damage to the charger and/or property:

	<p>This symbol means: DANGER</p> <p>This symbol is intended to highlight a dangerous situation for yourself and others. Read it carefully. Failure to comply with the instruction will result in an imminent hazardous situation which, if not avoided, will result in instant death, or serious or permanent injury.</p>
	<p>This symbol means: WARNING</p> <p>This symbol is intended to highlight safety information. Failure to comply with the instruction will result in a potentially hazardous situation which, if not avoided, could result in death or serious injury.</p>
	<p>This symbol means: CAUTION</p> <p>This symbol is intended to highlight safety information. Read it carefully. Failure to follow these instructions can result in death, serious injury or damage to equipment.</p>
	<p>This symbol means: NOTE</p> <p>Provides additional information to supplement instructions provided.</p>
	<p>This symbol means: NOTICE</p> <p>Provides instructions concerning the use of conduct necessary to handle the operations not associated with possible physical injuries.</p>

Installation must be carried out by qualified personnel. A dedicated, state-of-the-art electricity supply system must be designed and installed, and the system must be certified in compliance with local regulations and the energy supply contract.

Operators are required to read and fully understand this manual, and to comply strictly with the instructions it contains.

Free2move eSolutions S.p.A. cannot be held liable for damage caused to persons and/ or property, or to the equipment, if the conditions described in this document have not been complied with.





WARNING: Installation must be carried out in accordance with the regulations in force in the country of installation, and in compliance with all safety regulations for carrying out electrical work.

1.5. Personal Protective Equipment (PPE)

Personal Protective Equipment (PPE) means any equipment intended to be worn by the workers in order to protect them against one or more hazards likely to threaten their health or safety at the workplace, as well as any device or accessory intended for this purpose.

Since all the PPE indicated in this manual is intended to protect the personnel against health and safety hazards, the Manufacturer of the charger which is the subject of this manual recommends strict compliance with the indications contained in the various sections of this manual.

The list of PPE to be used in order to protect the operators against the residual risks present during the installation and maintenance interventions described in this document is provided below.

Symbol	Meaning
	Wear protective gloves
	Wear anti-static footwear



WARNING: It is responsibility of the operator to read and understand local regulations and evaluate the environmental conditions of the installation site in order to comply the need to wear additional PPE.

1.6. Warranty and delivery conditions

The warranty details are described in the Terms and Conditions of Sale included with the purchase order for this product and/or in the packaging of the product.

Free2move eSolutions S.p.A. assumes no responsibility for failure to comply with the instructions for proper installation, and cannot be held responsible for systems upstream or downstream of the equipment supplied.

Free2move eSolutions S.p.A. cannot be held responsible for defects or malfunctions deriving from: improper use of the charger; deterioration due to transport or particular environmental conditions or installation by unqualified persons.

Free2move eSolutions S.p.A. is not responsible for any disposal of the equipment, or parts thereof, that does not comply with the regulations and laws in force in the country of installation.



NOTICE: Any modification, manipulation or alteration of the hardware or software not expressly agreed with the manufacturer will immediately void the warranty.

1.7. List of documents

In addition to this manual, product documentation can be viewed and downloaded by visiting: www.esolutions.free2move.com.

1.8. Warnings



DANGER: Risk of electric shock and fire. Installation must be carried out in accordance with the regulations in force in the country of installation, and in compliance with all safety regulations for carrying out electrical work.

- Before installing or using the device, make sure that none of the components have been damaged. Damaged components can lead to electrocution, short circuits, and fire due to overheating. A device with damage or defects must not be used.
- Install **eLuxWallbox** away from petrol cans or combustible substances in general.
- Before installing **eLuxWallbox compatible accessories**, ensure the main power source has been disconnected.
- The **eLuxWallbox compatible accessories** must only be used for the specific applications they are designed for.
- Installation not carried out correctly may pose risks to the user.
- The charger must be connected to a mains network in compliance with local and international standards, and all the technical requirements indicated in this manual.
- Children or other persons not able to gauge risks related to the installation of the charger could suffer serious injury or put their lives at risk.
- Pets or other animals must be kept away from the device and packaging material
- Children must not play with the device, accessories or packaging provided with the product.
- The only part that can be removed from **eLuxWallbox**, is the removable cover. Access under the cover is only permitted by qualified personnel during installation, dismantling or maintenance.
- **eLuxWallbox** can only be used with an energy source.
- Necessary precautions to ensure safe operation with Active Implantable Medical Devices must be taken. To determine whether the charging process could adversely affect the medical device, please contact its manufacturer.

2. GENERAL INFORMATION

eLuxWallbox is an Alternate Current charging solution for powering electric vehicles and hybrid plug-ins, and is ideal for semi-public and residential use. The charger is available in three-phase or single-phase configurations and is equipped with a Type 2 socket.

The charger charges electric vehicles up to 22 kW in three-phase, or up to 7.4 kW in single-phase. The charger includes connectivity options such as remote monitoring via the eSolutions control platform (CPMS). Its final configuration must be completed using the **PowerUp** application. For the end user, the **eLuxWallbox** can be managed via the dedicated user's eSolutions Charging App. Both applications are available on Google Play™ and Apple Store®.

This charger is equipped with a SIM card for connection to the 4G mobile network.

The SIM card is automatically activated the first time the charger is turned on.

This document describes how to install the external accessories compatible with the **eLuxWallbox**.

The external accessories described in this manual are:

- **PowerMeter (DPM)**: an energy meter that enables the Dynamic Power Management (**DPM**) which is a smart function that allows an electric vehicle to be recharged using only the power available at home, modulating the charging power and avoiding unpleasant blackouts.
- **MIDcounter**: a certified energy meter that allows to monitor the consumption of the **eLuxWallbox** during each charging session.

This manual contains a description of the characteristics of the different accessories, information on models, installation process and final configuration of the devices.

The **eLuxWallbox** is configured to be used with the following electrical accessories: **PowerMeter (DPM)** or **MIDcounter**:

- Gavazzi, 1-phase, Direct, 32 A
- Finder, 1-phase, Direct, 40 A
- Gavazzi, 3-phase, Direct, 65 A
- Finder, 3-phase, Direct, 80 A

PowerMeter (DPM):

- Gavazzi, 1-phase, Indirect with 1x CT 100 A
- Gavazzi, 1-phase, Indirect with 1x CTV 60 A
- Gavazzi, 3-phase, Indirect with 3x CT 150 A



WARNING: Do not try to install the Electrical Accessories if you are not qualified as a professional electrician. To do so could cause serious danger and harm to you and to the people, property or animals around you.

To complete the installation, it is necessary to configure the **eLuxWallbox** through the dedicated apps:

	Installer's app: PowerUp
Product versions (EU):	EPRO23S224GWBAX
Product versions (UK):	EPRO23S224GWBAS



WARNING: Only Electrical Accessories suggested by Free2move eSolutions S.p.A. are compatible. Installation must be performed by qualified personnel in accordance with local regulations.

2.1. Fields of use

Free2move eSolutions S.p.A. declines all liability for any damage whatsoever due to incorrect or careless actions.

The charger may not be used for any purpose other than the one it is intended to fulfill.

The equipment must not be used by children or people with limited mental or physical abilities, or even by adults or expert professionals if the charger undergoes operations that do not comply with this manual and accompanying documentation.

The charger is a charging device for electric vehicles; the following classification (according to IEC 61851-1) identifies its characteristics:

- Power supply: permanently connected to the AC power supply grid
- Output: Alternate Current
- Environmental conditions: indoor / outdoor use
- Fixed installation
- Protection against electric shock: Class I
- EMC Environment classification: Class B
- Charging type: Mode 3 according to the IEC 61851-1 standard
- Optional function for ventilation not supported

3. ACCESSORIES INSTALLATION

To install the electrical accessories, it is necessary to use Modbus communication cables with the following characteristics:

- Modbus RS485 twisted STP 2x2 AWG24 or S/FTP cat.7 suitable for installation with a 400V power line
- Conductor size: 0.5 mm²
- Stripping length: 10 mm
- Recommended maximum length: 150 m

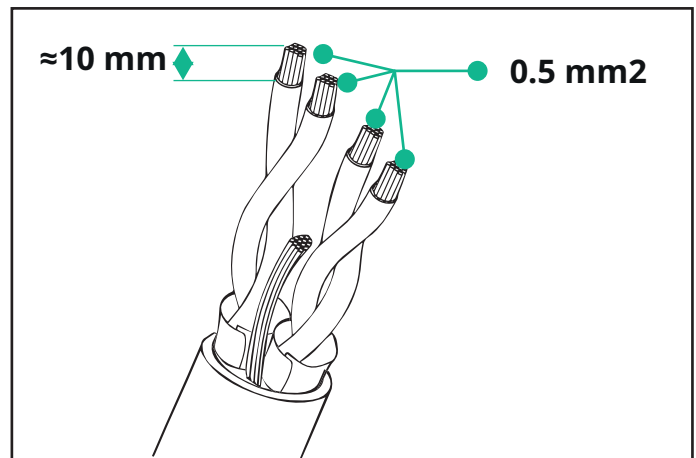

3.1. Installing PowerMeter (DPM)

PowerMeter (DPM) is an energy meter that enables the Dynamic Power Management (**DPM**) which is a smart function that allows an electric vehicle to be recharged using only the power available at home, modulating the charging power and avoiding unpleasant blackouts. Whenever other appliances are being used during the charging session, the system can modulate the charging power towards the car, even temporarily suspending the charging session. As soon as the other domestic appliances are switched off, the session will resume.

The **DPM** smart logic works both in three-phase and in single-phase installations.



WARNING: When installing in three-phase systems, make sure that the electrical loads (including the wallbox) are well balanced between the phases of the electrical system.



WARNING: Before carrying out any installation or maintenance work on the device, it must be ensured that the power supply is switched off.

For Direct models of the PowerMeter (DPM):

Place the **PowerMeter (DPM)** after the main utility meter. The **PowerMeter (DPM)** must measure all the electrical loads, including the **eLuxWallbox**.

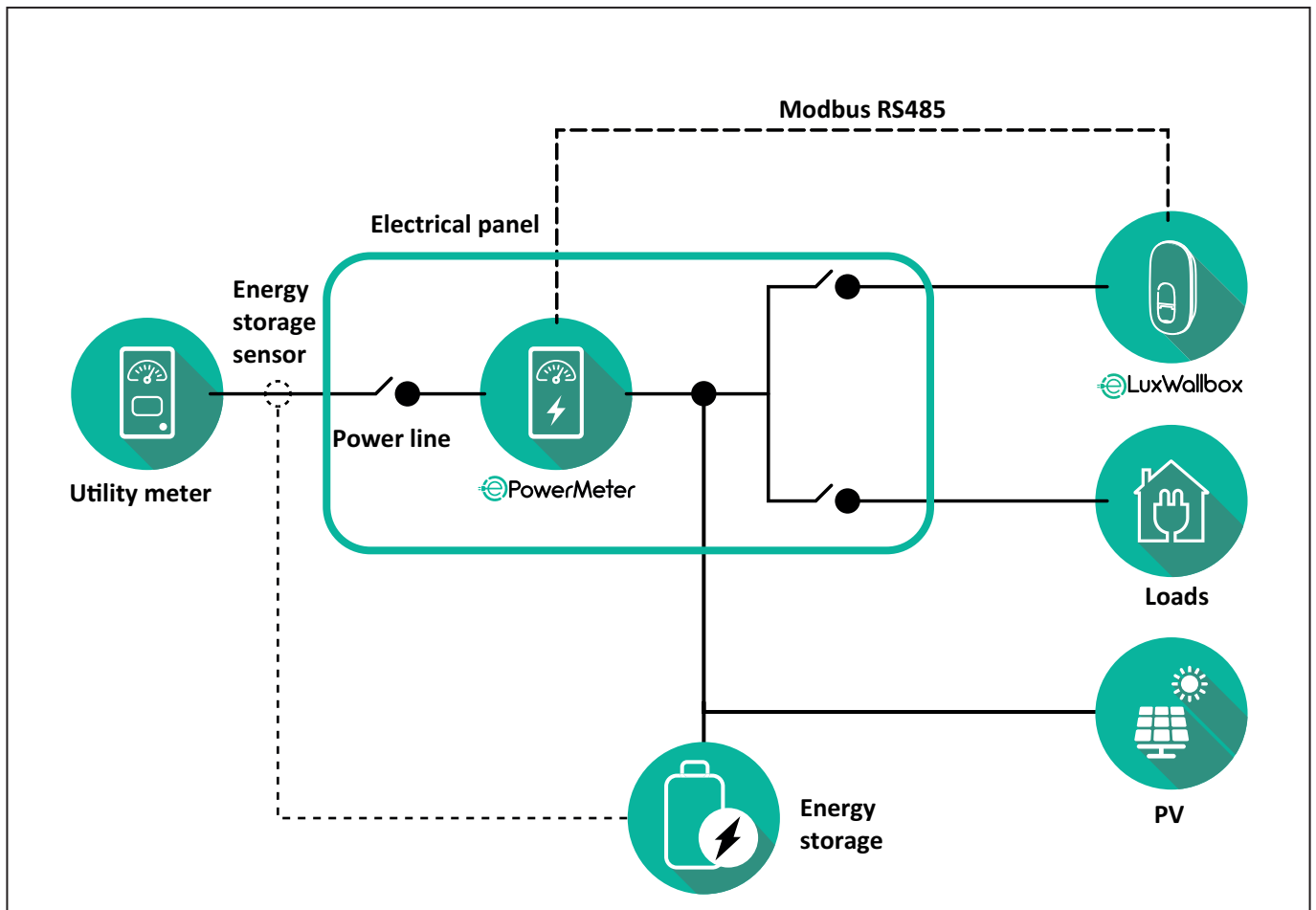

For Direct models of the PowerMeter:



WARNING: During the installation always refer to the manufacturer installation manual provided with the meter.



NOTE: For the single-phase or three-phase electrical connection of the Direct **PowerMeter**, please refer to the diagrams below.

Finder model 1ph and 3ph

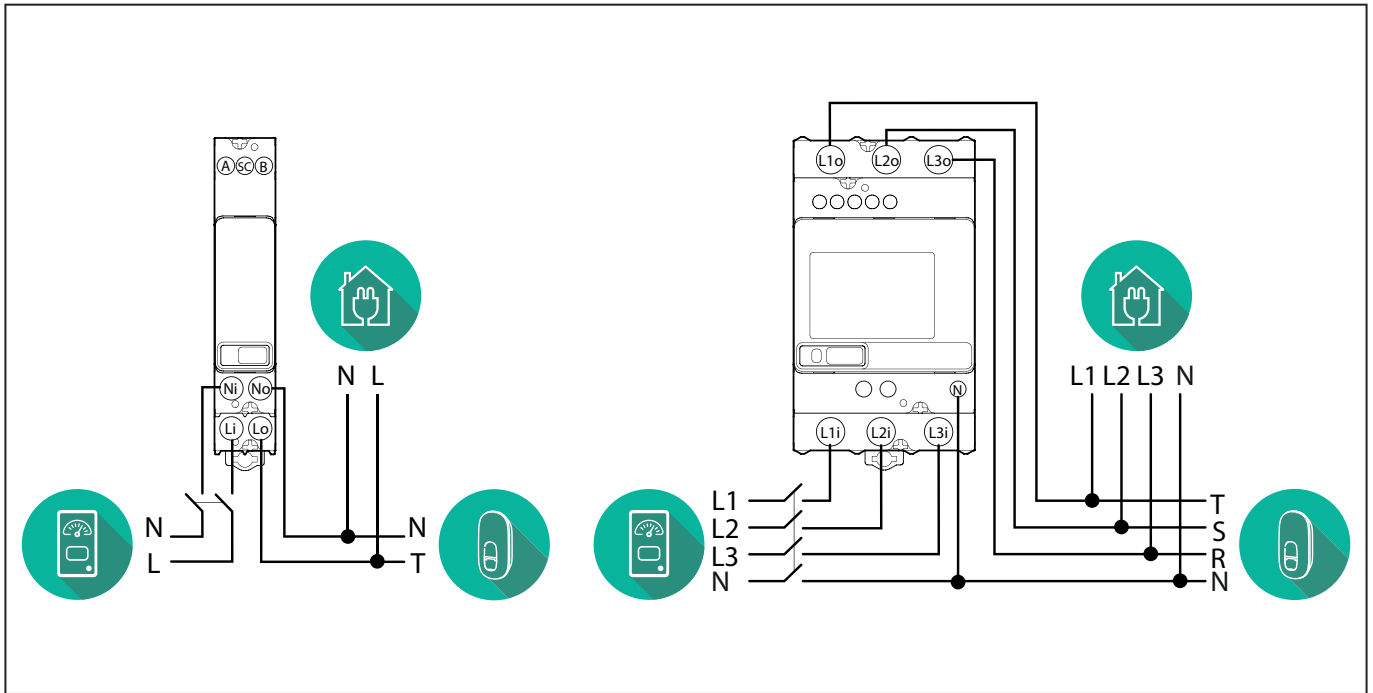

Gavazzi model 1ph and 3ph

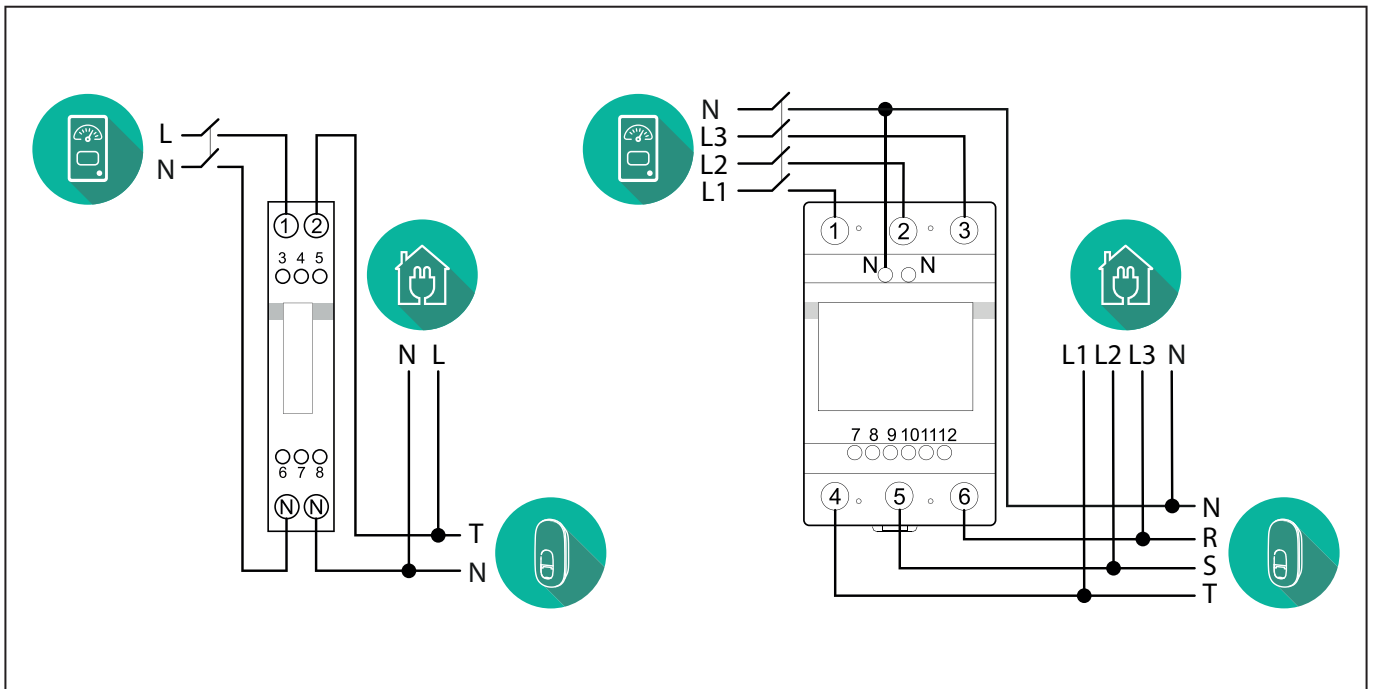

NOTICE:



- 1) If PV is present, the **PowerMeter** should be placed between the Utility Meter and the PV connection point.
- 2) If there is a home Energy storage, the **PowerMeter** should be placed between the Energy storage connection point and the Energy storage measurement sensor.

For Indirect models of the PowerMeter:

Place the CT (current transformer) of the **PowerMeter** after the main utility meter and before the main switch of the house/building. The current transformer must measure all the domestic loads, including the **eLuxWallbox**.

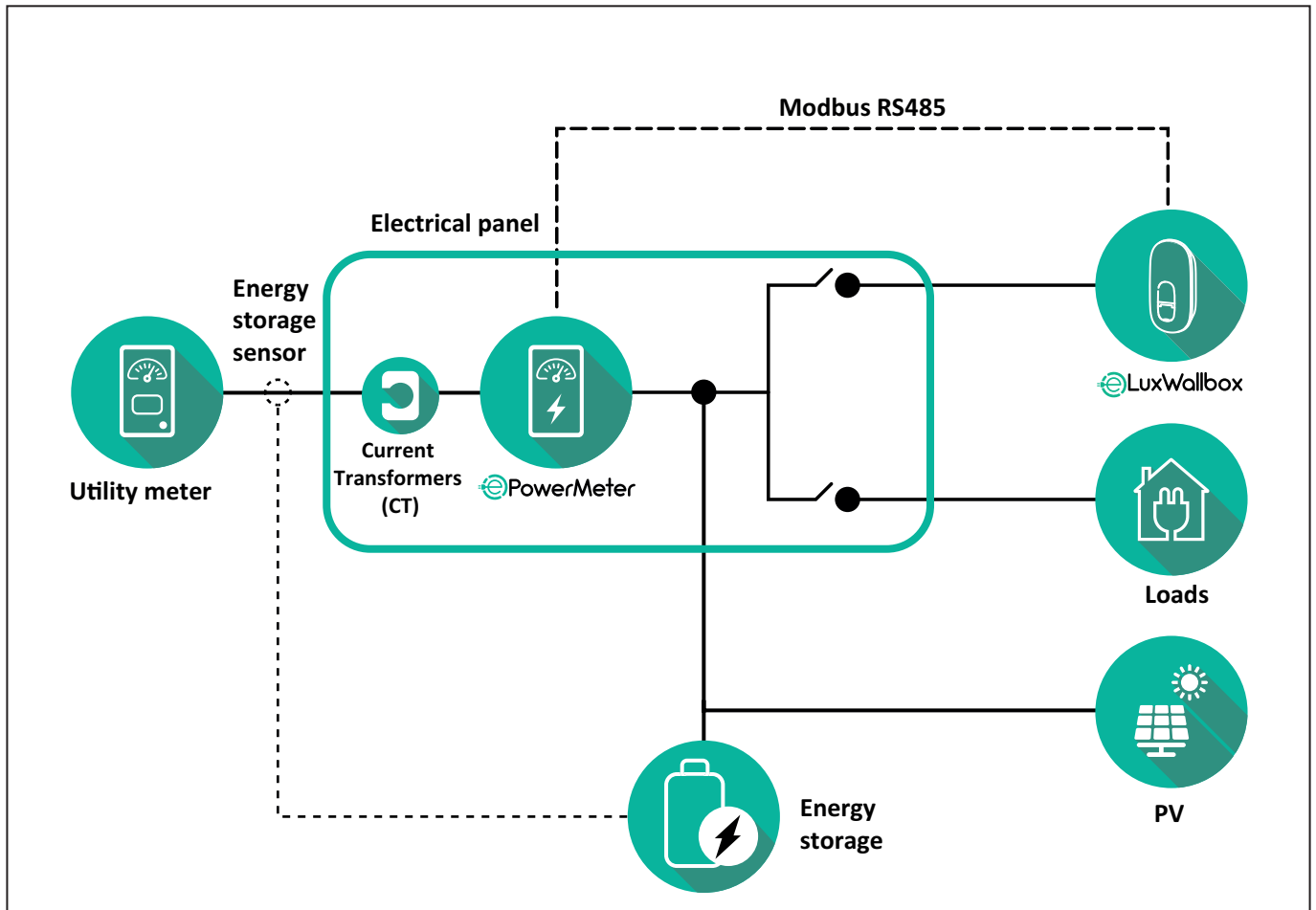

NOTICE:



1) If PV is present, the **PowerMeter** Current Transformers (CT) should be placed between the PV connection point and the Utility Meter.

2) If there is a home Energy storage, the **PowerMeter** Current Transformers (CT) should be placed between the Energy storage connection point and the Energy storage measurement sensor.

Connect the Current Transformers (CT) as indicated in the meter installation manual. Point the arrow on the CT in the direction of the loads.

For the three-phase or single-phase electrical connection of the indirect **PowerMeter**, refer to the diagrams below.

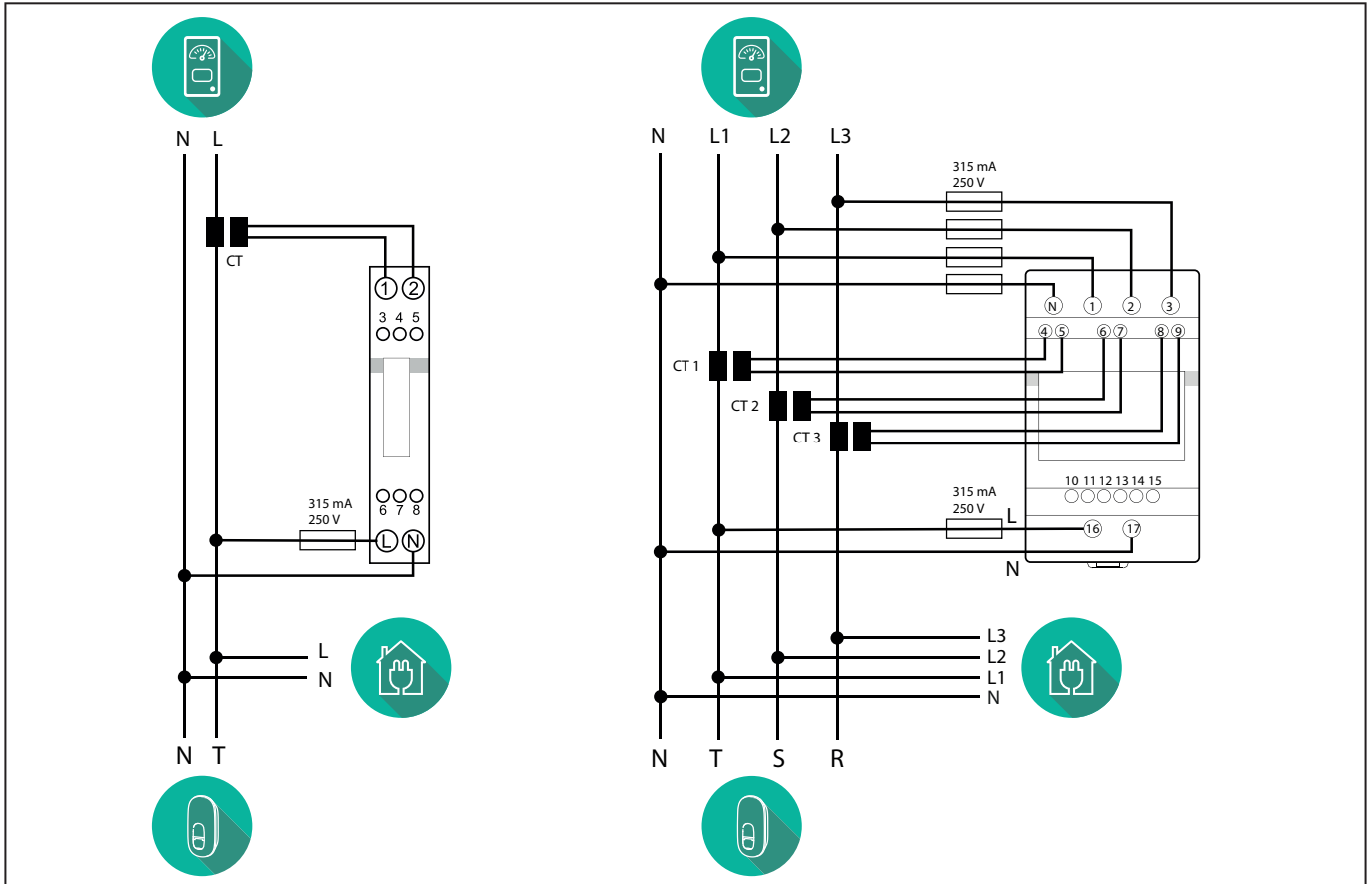

3.2. Installing MIDcounter

The **MIDcounter** is a certified energy meter that allows the consumption of the charger to be safely and reliably monitored during each charging session.

All the relevant data of the charging sessions is automatically recorded by a certified **MID** meter and transferred from the charger to the Charge Point Management System (CPMS).



WARNING: The power to the charger must remain off during this step.

Place the **MIDcounter** on the same power line as the charger, after the electrical protection devices.

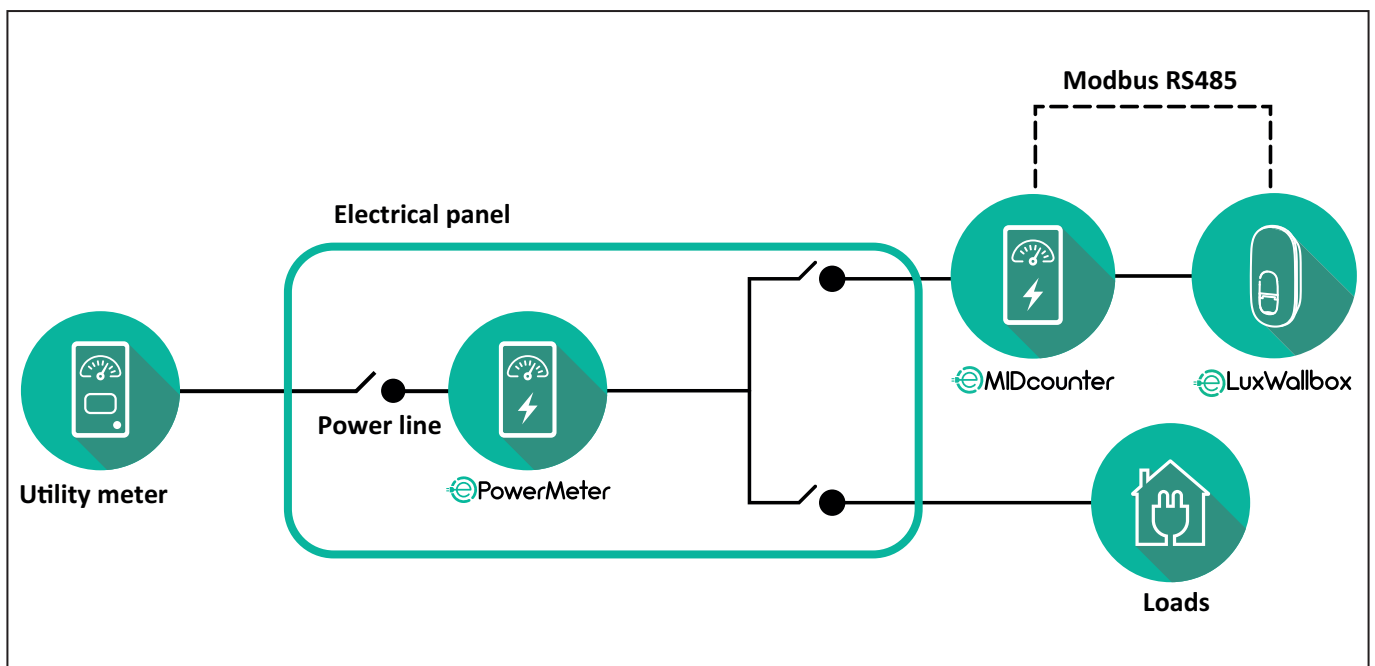

See the diagrams below for single phase and three phase electrical connection of **MIDcounter** (Finder and Gavazzi).

**Finder 1-phase, Direct, 40 A
(7M2482300210)**

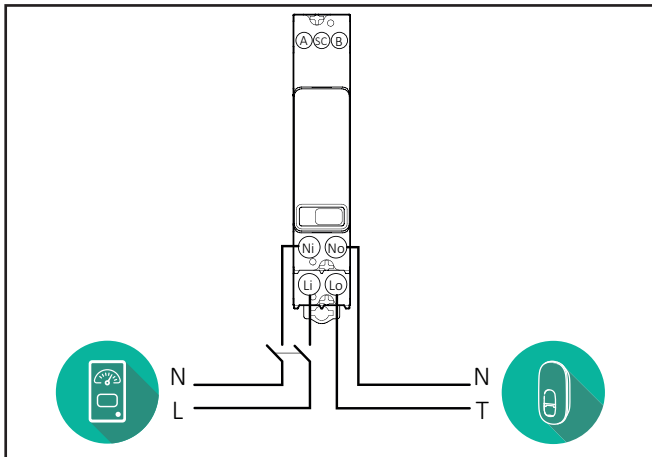

**Gavazzi, 3-phase, Direct, 65 A
(EM340DINAV23XS1PFB)**

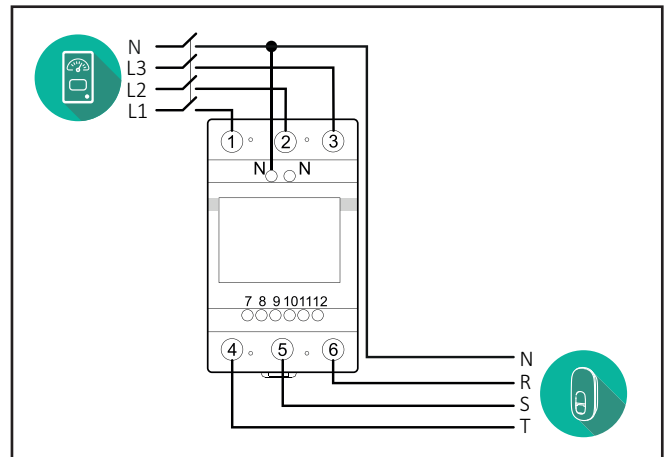

**Finder 3-phase, Direct, 80 A
(7M3884000212)**

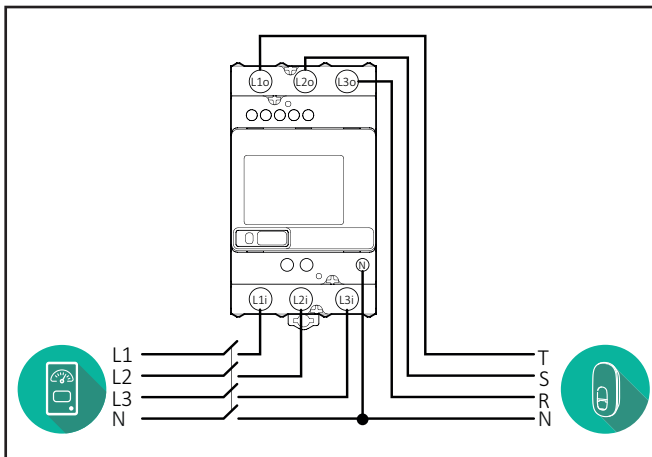

**Gavazzi, 1 phase, Direct, 100 A
(EM112DINAV01XS1PFB)**

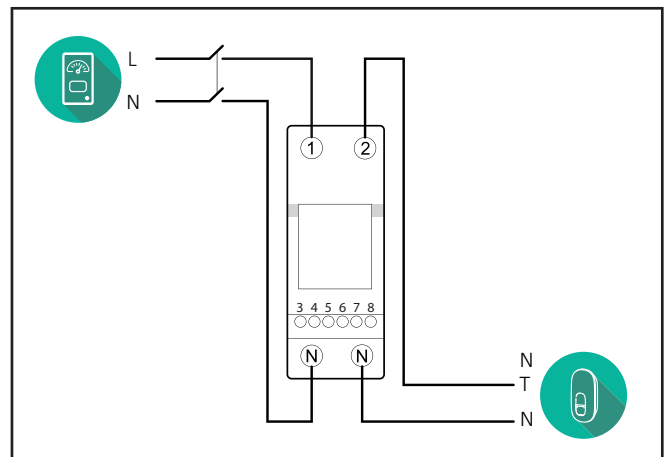

**Gavazzi, 1-phase, Direct, 32 A
(EM111DINAV81XS1PFB)**

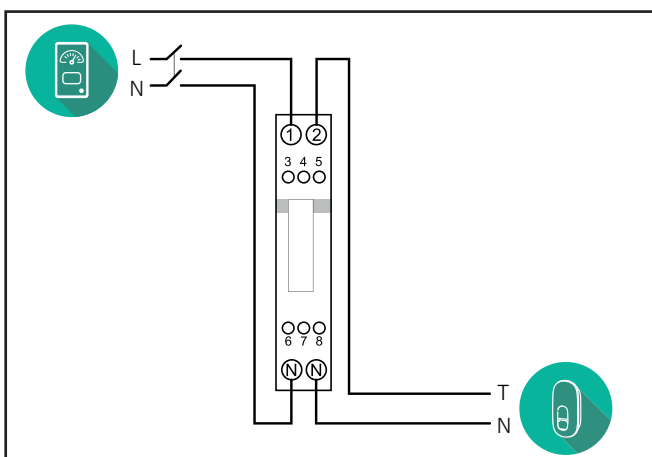

3.3. Communication cable installation

Install a communication cable between the **PowerMeter (DPM)** and the **eLuxWallbox**.

- On the **eLuxWallbox**, remove the protective cap of the communication cables entry point and insert the \varnothing 25 mm corrugated sheath.
- Tighten the box-cable sheath junction.
- Insert the communication cable, pulling it to a suitable length so that it reaches the communication port CN12, leaving some slack.
- Connect the Modbus RS485 communication cable to the GND, - and + pins of the CN12 connector.



NOTE: It is possible to replace the box-cable sheath junctions with \varnothing 25mm cable gland (not provided by the manufacturer).

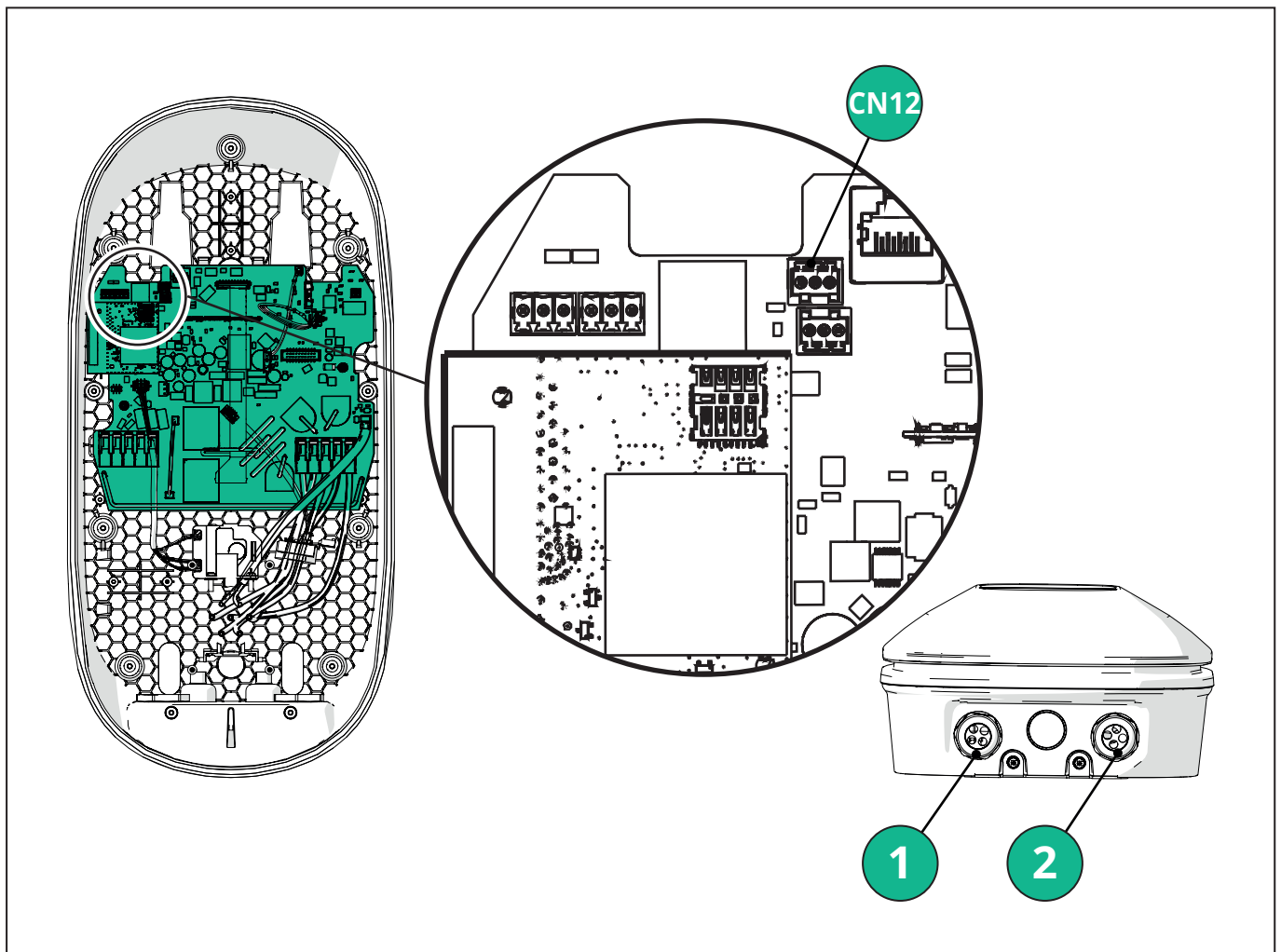

1 - Power supply cables

2 - Communication cables

CN12 - RS485 Modbus for external meter communication (**DPM** and **MID**)

Connect the communication cables in the following order from the **PowerMeter (DPM)** to **eLuxWallbox**.



WARNING: If the installation includes both accessories, follow the instructions for "MIDcounter and PowerMeter (DPM) combined installation".

CN12	Finder 1ph 7M.24.8.230.0210
GND	SC
-	B
+	A

CN12	Gavazzi 3ph EM340DINAV23XS1PFB
GND	10
-	9
+	8

Junction 9/7

CN12	Finder 3ph 7M.38.8.400.0212
GND	SC
-	B
+	A

CN12	Gavazzi Ind 1ph EM111DINAV51XS1X / EM111DINMV51XS1X
GND	7
-	8
+	6

Junction 8/5

CN12	Gavazzi 1ph EM111DINAV81XS1PFB
GND	7
-	8
+	6

Junction 8/5

CN12	Gavazzi Ind 3ph EM330DINAV53HS1X
GND	13
-	12
+	11

Junction 12/10

3.4. MIDcounter and PowerMeter (DPM) combined installation

If installing both electrical accessories, the positioning of **MIDcounter** together with the **PowerMeter (DPM)** is indicated in the diagram below:

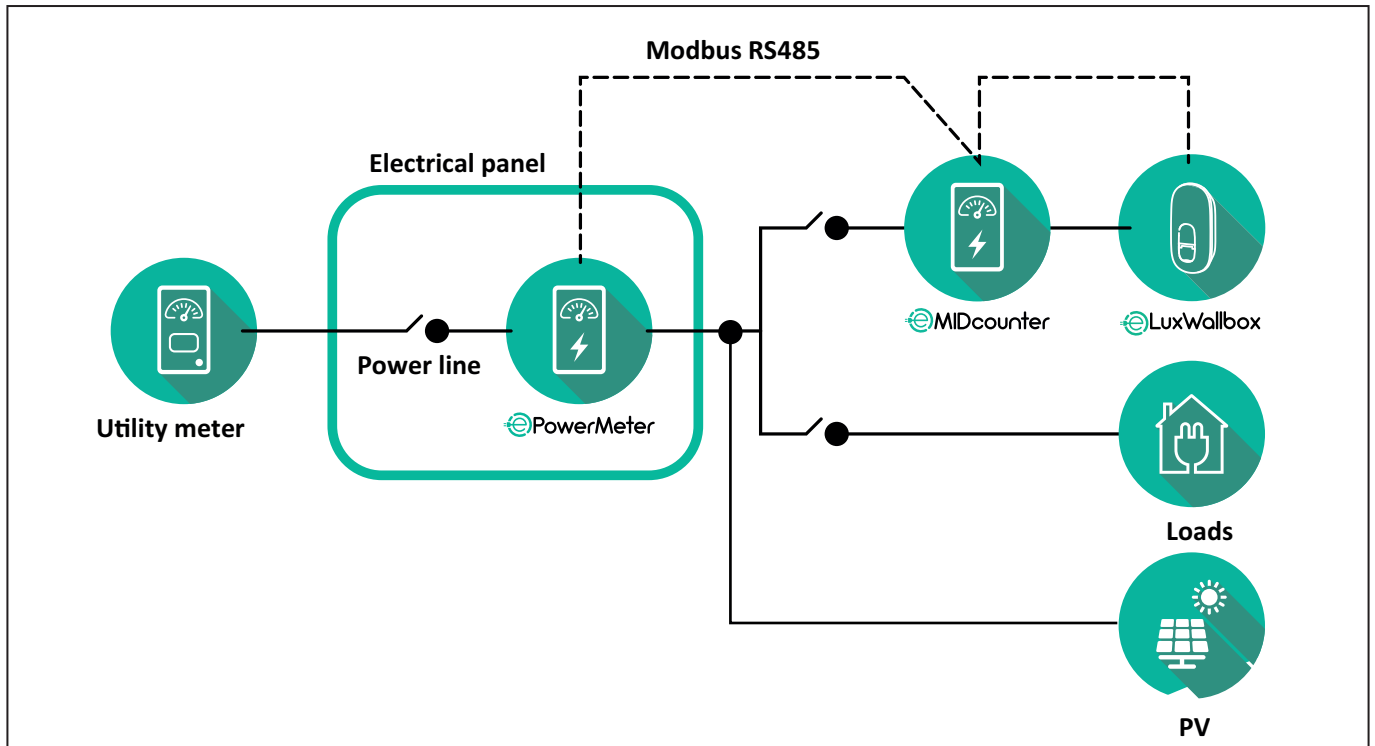

Connect the Modbus communication cables. The **PowerMeter (DPM)**, **MIDcounter** and the **eLuxWallbox** must be connected on the same communication bus in a Daisy chain format.

On the **eLuxWallbox**:

- Remove the protective cap of the communication cable entry point and insert the \varnothing 25 mm corrugated sheath.
- Tighten the box-cable sheath junction.
- Insert the communication cable, pulling it to a suitable length so that it reaches the communication port CN12, leaving some slack.
- Connect the Modbus RS485 communication cable to the GND, - and + pins of the CN12 connector.

Use the table below to connect the communication cables from the accessories to the **eLuxWallbox**.

Single-Phase.

PowerMeter (DPM)	MIDcounter	eLuxWallbox
EM111DINAV51XS1X - EM111DINMV51XS1X	EM111DINAV81XS1PFB	CN12
GND (7)	GND (7)	GND
A- (8) / T*(5)	A- (8)	-
B+ (6)	B+ (6)	+
EM111DINAV51XS1X - EM111DINMV51XS1X	7M 24.8.230.0210	CN12
GND (7)	SC	GND
A-(8) / T*(5)	B-	-
B+ (6)	A+	+
EM111DINAV81XS1PFB	EM111DINAV81XS1PFB	CN12
GND (7)	GND (7)	GND
A-(8) / T*(5)	A- (8)	-
B+ (6)	B+ (6)	+
EM111DINAV81XS1PFB	7M 24.8.230.0210	CN12
GND (7)	SC	GND
A-(8) / T*(5)	B-	-
B+ (6)	A+	+
7M 24.8.230.0210	EM111DINAV81XS1PFB	CN12
SC	GND (7)	GND
B-	A- (8)	-
A+	B+ (6)	+
7M 24.8.230.0210	7M 24.8.230.0210	CN12
SC	SC	GND
B-	B-	-
A+	A+	+

Three-Phase.

PowerMeter (DPM)	MIDcounter	eLuxWallbox
EM330DINAV53HS1X	EM340DINAV23XS1PFB	CN12
GND (13)	GND (10)	GND
A-(12) / T*(10)	A-(9)	-
B+ (11)	B+ (8)	+
EM330DINAV53HS1X	7M.38.8.400.0212	CN12
GND (13)	SC	GND
A-(12) / T*(10)	B-	-
B+ (11)	A+	+
EM340DINAV23XS1PFB	EM340DINAV23XS1PFB	CN12
GND (10)	GND (10)	GND
A-(9) / T*(7)	A-(9)	-
B+ (8)	B+ (8)	+
EM340DINAV23XS1PFB	7M.38.8.400.0212	CN12
GND (10)	SC	GND
A-(9) / T*(7)	B-	-
B+ (8)	A+	+
7M.38.8.400.0212	EM340DINAV23XS1PFB	CN12
SC	GND (10)	GND
B-	A-(9)	-
A+	B+ (8)	+
7M.38.8.400.0212	7M.38.8.400.0212	CN12
SC	SC	GND
B-	B-	-
A+	A+	+

*A 120 Ω terminating resistor must be installed on the devices at the ends of the Modbus chain. The resistor is present by default in the **eLuxWallbox**. Gavazzi models have a built-in resistor, which can be enabled by making a jumper between these terminals.

4. PowerMeter (DPM) and MIDcounter configuration

Power on the **PowerMeter (DPM)** and/or the **MIDcounter** when the electrical installation and communication installation are complete. Then proceed with the configuration on the display of the meters.

The configuration varies depending on the model.

4.1. Finder models

The following actions help to understand how to set Finder energy meters:

- Press the touchscreen button (a,b) to move between menus and parameters;
- Long press (~ 2 seconds) the touchscreen button (a,b) to enter and confirm selections

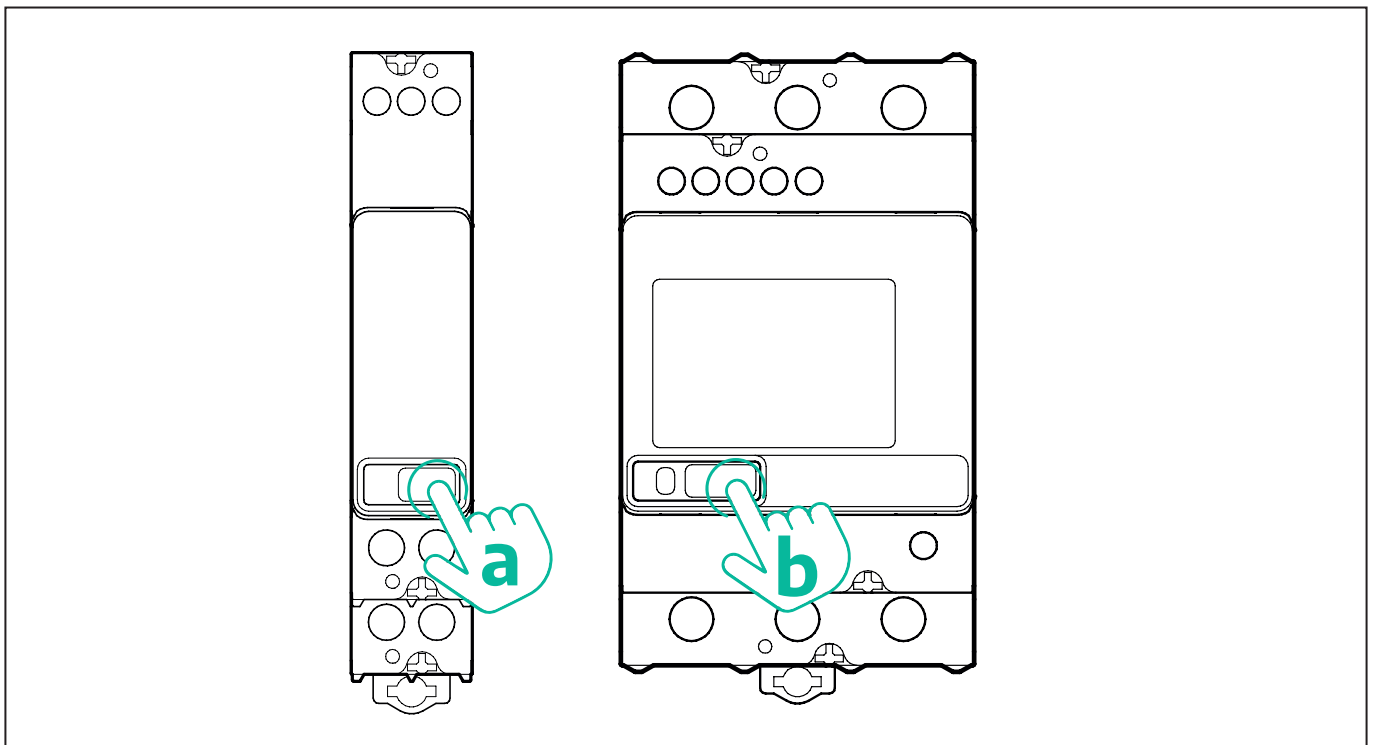

Follow the next steps to correctly configure the single-phase or three-phase Finder energy meters:

- When powering up the energy meter for the first time, long press the touchscreen button (a,b) until the display text blinks in order to enter the "MAIN" menu;
- Scroll the "MAIN" menu pressing the touchscreen button (a,b), then select "SETTING" ("SET" on single-phase meter). Long press to enter the selection.
- Scroll the "SETTING" menu pressing the touchscreen button (a,b), then select "COMMUNICATION" ("COMM" on single phase meter). Long press to enter the selection.
- Insert the correct values indicated in the table below. To modify the value press the touchscreen button (a,b), long press to confirm.

Only for three-phase Finder meter (in addition to previous options):

- Long press the touchscreen button (a,b) until the display text blinks in order to enter the "MAIN" menu (or return to the "MAIN" menu)
- Scroll the "MAIN" menu pressing the touchscreen button (a,b), then select "INSTALLATION". Long press the touchscreen button (a,b) to enter the selection
- Scroll the "INSTALLATION" menu pressing the touchscreen button (a,b) and then select the following option
 - "Communication mode" = "3L+N, L+N-Arithmetic"
 - Once the correct option is confirmed, enter the password: "DCBA" **Attention:** configuration cannot be modified after entering the password **DCBA**
 - Confirm the change selecting "Yes" when prompted.

ALL FINDER MODELS	PowerMeter (DPM)	MIDcounter
DEVICE ADDRESS	1	2
BITS PER SECOND (BAUD)	38400 bit/s	38400 bit/s
PARITY	Even	Even
STOP BIT	1	1
Additional for three-phase type		
	PowerMeter (DPM)	MIDcounter
COMMUNICATION MODE	3L+N, L+N-Arithmetic	3L+N, L+N-Arithmetic
PASSWORD	DCBA	DCBA

4.2. Gavazzi models

The following actions help to understand how to set Gavazzi energy meters:

- Press the touchscreen buttons (c, d, e, g) to move between menus and values
- press (~ 2 seconds) the touchscreen button (d, f) to enter the menu and confirm selections

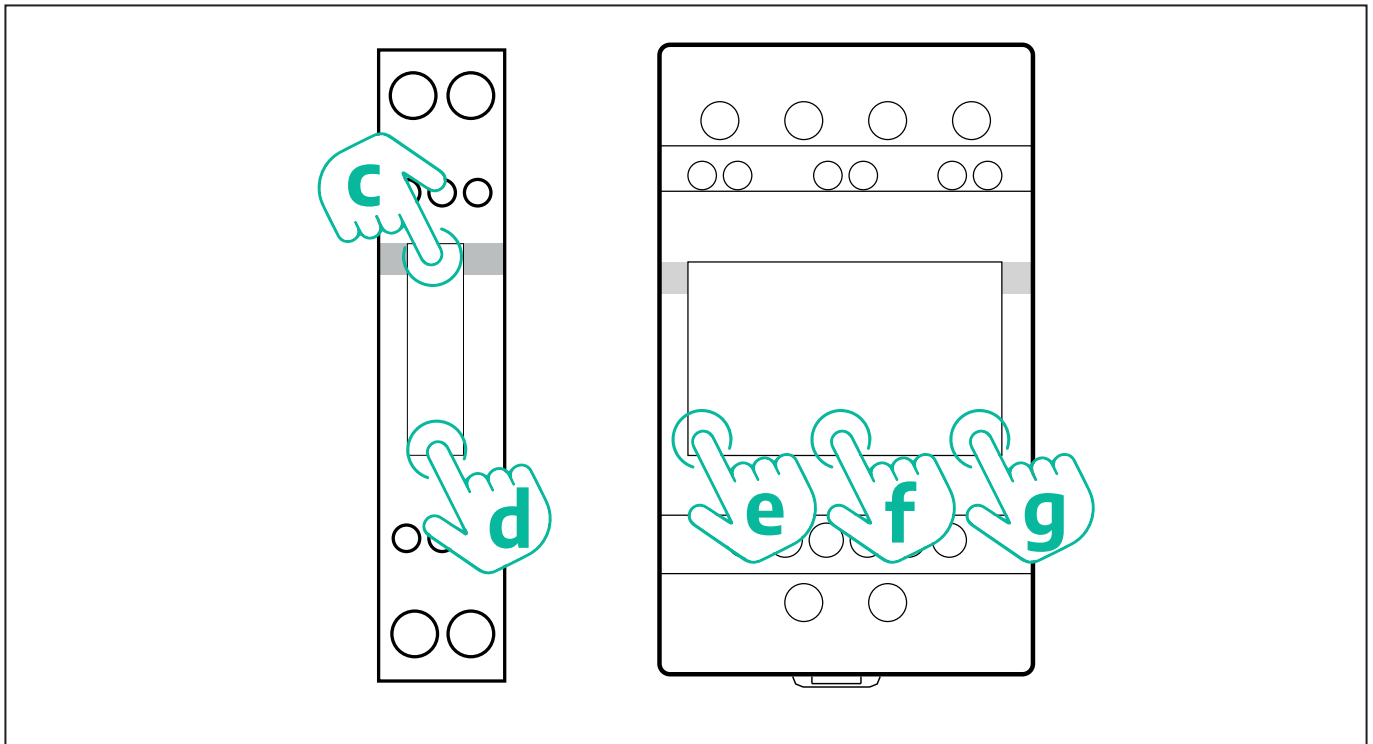

Follow the next steps to correctly configure the single-phase Gavazzi direct and indirect energy meters.

- When powering up the energy meter for the first time, long press the touchscreen button (d) until the password appears on the screen
- Long press the buttons (c, d) simultaneously in order to confirm the password "0000" and enter the "MAIN" menu
- Scroll the "MAIN" menu pressing the upper button (c) and then select the following options in the table below

Follow the next steps to correctly configure the three-phase Gavazzi direct and indirect energy meters:

- When powering up the energy meter for the first time, long press the central button (f) until the password appears on the screen;
- Long press the buttons (e, g) simultaneously in order to confirm the password "0000" and enter the "MAIN" menu
- Scroll the "MAIN" menu pressing the buttons (e or g) and then select the options in the table below

ALL GAVAZZI MODELS	PowerMeter (DPM)	MIDcounter
PASS	0000	0000
ADDRESS	001	002
BAUD	38.4	38.4
PARITY	Even	Even
Additional for three-phase type		
	PowerMeter (DPM)	MIDcounter
SYSTEM	3Pn	3Pn
ADDRESS	001	002

4.3. Device configuration summary

EM340DINAV23XS1PFB / EM330DINAV53HS1X		EM340DINAV23XS1PFB	
PASS	0000	PASS	0000
SYSTEM	3Pn	SYSTEM	3Pn
ADDRESS	1	ADDRESS	2
BAUD	38.4	BAUD	38.4
PARITY	EVEN	PARITY	EVEN

EM111DINAV81XS1PFB / EM111DINAV51XS1X / EM111DINMV51XS1X		EM111DINAV81XS1PFB	
PASS	0000	PASS	0000
ADDRESS	001	ADDRESS	002
BAUD	38.4	BAUD	38.4
PARITY	EVEN	PARITY	EVEN

7M 24.8.230.0210		7M 24.8.230.0210	
DEVICE ADDRESS	__ 1	DEVICE ADDRESS	__ 2
BITS PER SECOND (BAUD)	38400 bit/s	BITS PER SECOND (BAUD)	38400 bit/s
PARITY	EVEN	PARITY	EVEN
STOP BIT	1	STOP BIT	1

7M.38.8.400.0212		7M.38.8.400.0212	
DEVICE ADDRESS	__ 1	DEVICE ADDRESS	__ 2
BITS PER SECOND (BAUD)	38400 bit/s	BITS PER SECOND (BAUD)	38400 bit/s
PARITY	EVEN	PARITY	EVEN
STOP BIT	1	STOP BIT	1
CONNECTION MODE	3L+N, L+N - Arithmetic	CONNECTION MODE	3L+N, L+N - Arithmetic
PASSWORD	DCBA	PASSWORD	DCBA

4.4. PowerMeter (DPM) and MIDcounter configuration on APP

To complete installation, the final configuration of the **eLuxWallbox** and its accessories should be set via the dedicated app

PowerUp is a smartphone app for qualified installers only, available via Google Play™ and Apple Store®. The configuration is carried out via a Bluetooth connection. The wallbox cannot operate correctly if not configured via the app.



NOTICE: Make sure you have the latest version of PowerUp to have access to all of the features.

Follow the instructions below to get started with the app:

Download PowerUp to your smartphone and activate Bluetooth on the smartphone.



Scan **eLuxWallbox** QR code to pair it with the app. The QR Code can be found on the side of the charger.

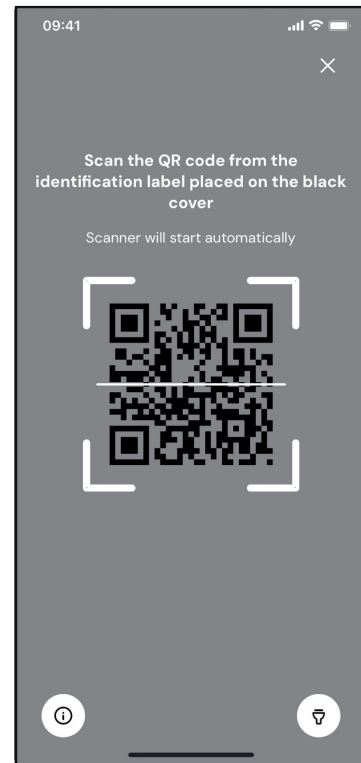

Once paired, complete the configuration set up of **eLuxWallbox** and its Accessories by clicking on the parameter to be configured.

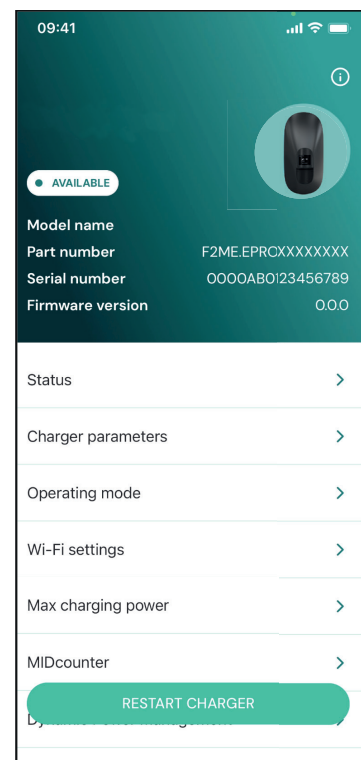

4.5. PowerMeter (DPM) configuration

To complete installation of the **PowerMeter (DPM)**, follow the steps below:

Select "**DPM PowerMeter**" on the homepage

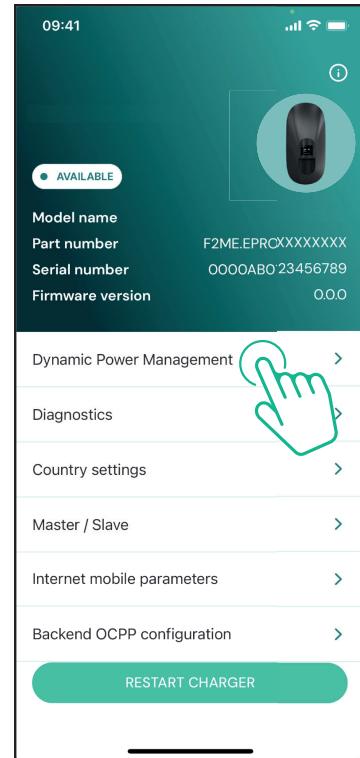

Select the **PowerMeter** type from the drop-down menu, matching the model installed.

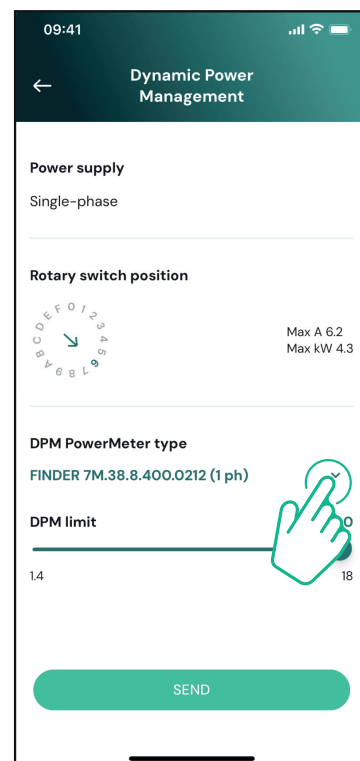

Enter the value of the user contractual power as **DPM** power limit.

For Indirect Meter only - Set the CT current ratio with the slider.

- With CTV 60 A set 60 as Current ratio
- With CTA 100 A set 20 as Current ratio
- With CTA 150 A set 30 as Current ratio

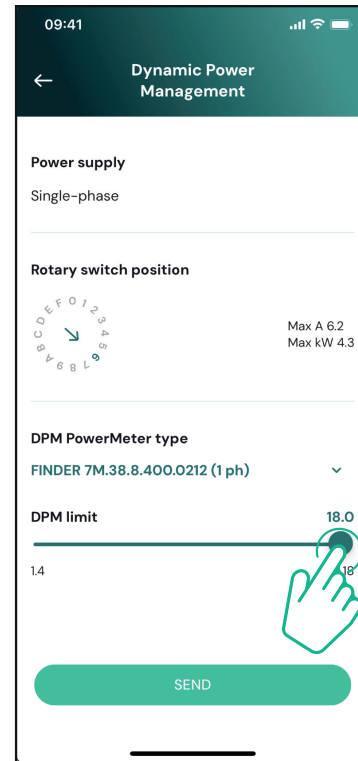

Click "Send" and confirm on the pop-up to restart **eLuxWallbox**.

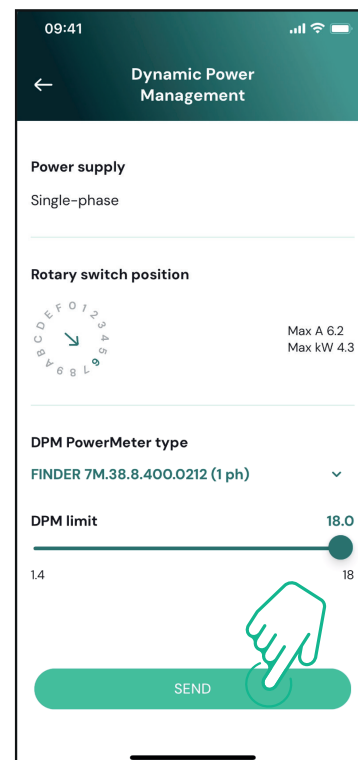

4.6. MIDcounter configuration

To complete installation of the **MIDcounter**, follow the steps below:

Select "**MIDcounter**" on the homepage

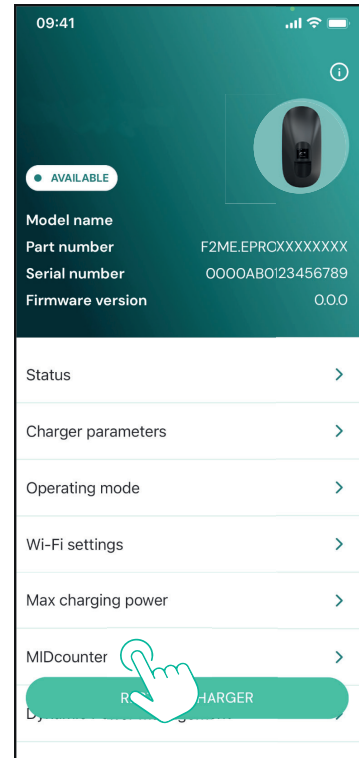

Select the **MIDcounter** type from the drop down menu, based on the model installed.

Select "OFF" from the drop down menu to disable the **MIDcounter** configuration.

Click "Send" to confirm.

To make the changes effective, click on the back arrow in the top left corner and restart **eLuxWallbox** through the dedicated button in the homepage.

If the installation has both the **PowerMeter (DPM)** and the **MIDcounter** it is possible to proceed with **DPM** configuration before restarting.

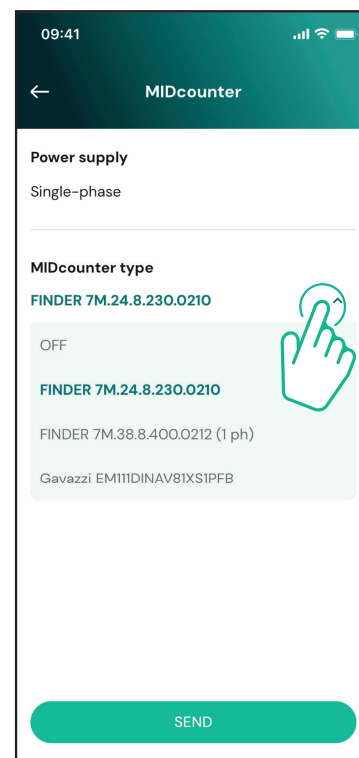

5. TROUBLESHOOTING

Error conditions are stored in the diagnostic logs and shown on the charger panel:

- On the **eLuxWallbox Move** model, the LED bar blinks red. See the **Diagnostic** section of PowerUP or the end-user App for the detailed error code.
- On the **eLuxWallbox** model, the display shows the error code, which is also available in the **Diagnostic** section of PowerUP.

When an error occurs, the charge is interrupted, and the socket is unlocked to allow you to disconnect the plug.

The following table provides a list of errors that can occur and the relative troubleshooting. If the error persists, note the serial number on the charger label and contact Customer Service.

Error code / issue	"Error Description"	Troubleshooting
100	Lack of power supply	<p>Check if the circuit breaker is ON. Check that the CN1 cabling is correct. Check the voltage in CN1.</p>
101	Overheating	<p>Disconnect the Type 2 cable, wait for the temperature to drop, then the error will clear.</p> <p>To restart the charging session, plug in the cable again. Make sure that installation site is compatible with temperature range (25°C/+50°C without direct exposure to sunlight)</p>
102	Communication error between MCU and MPU.	<p>Restart the charger from the circuit breaker, leaving the charger switched off for at least 60 seconds.</p>
103	Hardware fault, ground protection device error (GPD error)	<p>Check the cabling on CN1:</p> <ul style="list-style-type: none"> - in single-phase, make sure that ground cable is connected to PE, the Neutral cable is connected to N and the phase cable to T - in three-phase, make sure that the ground cable is connected to PE, the Neutral cable is connected to N and the phase cables L1, L2 and L3 are connected to T, S, and R. <p>Check whether the voltage difference between PE and N does not exceed 10V. Check PE connection</p> <p>If all connections are checked and the error persists, open the charger and modify the configuration of the Dipswitch (SW2) connector.</p>

104	Hardware fault, residual current monitor AC error. (RCM AC trip)	<p>Try to start a new charging session, removing and plugging in all the connectors.</p> <p>If the problem persists, check for the presence of any problems in the charging cable or vehicle inlet.</p> <p>If the cables and the EV don't show any problem, check CN27 connector and RCM cable.</p>
105	Hardware fault, residual current monitor DC error. (RCM DC trip)	<p>Check that the problem is not with the cable or vehicle. If possible, try another charging session with a different cable or vehicle.</p>
106	Internal meter error	<p>Restart the charger from the circuit breaker, leaving the charger switched off for at least 60 seconds.</p>
107	PowerMeter (DPM) communication error	<p>Check that the communication configuration on the DPM PowerMeter device is correct.</p> <p>Check that the DPM model configuration in the installer App is correct.</p> <p>Check the communication cable wiring on CN12.</p> <p>Check that the communication cable used is suitable for Modbus RS485 and cable length.</p>
108	Configuration Error, Rotary switch position (supply type) is not consistent with the DPM/ MID type.	<p>Check the position of the rotary switch. If it is not consistent with the 1-ph/3-ph installation, change it according to the table in the manual, then restart the charger.</p> <p>If the accessories (DPM/MID) are not installed, make sure that the function is disabled in the installer App.</p> <p>If the accessories (DPM/MID) are installed, check that the correct model is selected on the installer App. Then restart the charger.</p>
109	Main/secondary RS485 communication error	<p>Check the configuration of the Main/Secondary set up from installer App.</p> <p>Check that the Main charger is available.</p> <p>Check that the wiring of the communication cable on CN9 and CN10 is correct.</p> <p>Check that the communication cable used is suitable for Modbus RS485.</p>

110	MIDcounter communication error	<p>Check that the communication configuration on the MIDcounter device is correct.</p> <p>Check the communication cable wiring on CN12.</p> <p>Check that the communication cable used is suitable for Modbus RS485.</p> <p>Check that the MID model configuration in the installer App is correct.</p>
300	Inconsistency between the charger contactor command and feedback	<p>Restart the charger from the circuit breaker, leaving the charger switched off for at least 60 seconds.</p> <p>If error persists even after restart, call Customer Service.</p>
301	Short circuit detected on the Control Pilot line.	<p>With the charger switched off, check that there is no damage and no defects inside and outside the socket (if so, avoid using the charger and contact Customer Service).</p> <p>Check that the problem is not related to the cable or vehicle and try another charge session (with another vehicle or cable if possible).</p>
302	State E or F set on the Control Pilot line.	<p>With the charger switched off, check that there is no damage and no defects inside and outside the cable and its connectors (if so, avoid using it and attempt charge with another cable).</p>
303	Control Pilot disconnected.	<p>Check that the cable connectors are fully inserted inside the charger socket and vehicle inlet.</p>
304	Proximity Pilot disconnected.	<p>Check that the problem is not related to the cable or vehicle and try another charge session (with another vehicle or cable if possible).</p>
305	Broken Proximity Pilot detected.	<p>Check that the problem is not related to the cable or vehicle and try another charge session (with another vehicle or cable if possible).</p>
306	Diode fault detected on Control Pilot line (no - 12V).	<p>Attempt a new charging session unplugging and reinserting the cable from both the charger and vehicle inlet.</p>
307	Control Pilot disconnected.	<p>With the charger switched off, check that there is no damage and no defects inside and outside the cable and its connectors (if so, avoid using it and attempt charge with another cable).</p> <p>Check that the cable connectors are fully inserted inside the charger socket and vehicle inlet.</p> <p>Check that the problem is not related to the cable or vehicle and try another charge session (with another vehicle or cable if possible).</p>

308	Inconsistency between the motor command and feedback, or the motor is in an error condition.	<p>Attempt a new charging session unplugging and reinserting the cable from both the charger and vehicle inlet.</p> <p>Check that the cable connectors are fully inserted inside the charger socket and vehicle inlet.</p>
309	Motor check error during EVSE initialization phase.	Restart the charger from the circuit breaker, leaving the charger switched off for at least 60 seconds.
310	Error detected before charging (PP not detected, or motor fault, or CP not detected).	<p>With the charger switched off, check that there is no damage and no defects inside and outside the cable and its connectors (if so, avoid using it and attempt charge with another cable).</p> <p>Check that the cable connectors are fully inserted inside the charger socket and vehicle inlet.</p>
311	Error detected after charging (motor fault, or CP not disconnected).	Check that the problem is not related to the cable or vehicle and try another charge session (with another vehicle or cable if possible).
312	Emergency stop received from the MPU.	Restart the charger from the circuit breaker, leaving the charger switched off for at least 60 seconds.
313	Current detected during charging, with 100% duty cycle on the Control Pilot line.	Check that the problem is not cable nor vehicle related, attempt a new charging session with another cable and/or charger.
315	Current over limits on phase L1	Unplug the cable, if possible lower the power of charge on the vehicle side and attempt a new charging session.
316	Current over limits on phase L2	
317	Current over limits on phase L3	
318	Voltage below a threshold on phase L1	<p>Check the rotary switch position is consistent with 1-ph/3-ph installation.</p> <p>Check that the voltage on CN1-T is above 196 V.</p> <p>If the voltage is below 196 V, check the electric system or contact the energy supplier.</p> <p>If an error occurs during vehicle charging, try to reduce the set-up charging power and verify that the electric system is correctly dimensioned for the power drawn by the vehicle.</p>

319	Voltage below a threshold on phase L2	The rotary switch is in a three-phase position. Check that the intended installation is in three-phase. If not, select the correct rotary switch position as per Installation Manual.
320	Voltage below a threshold on phase L3	<p>Check that the voltage on CN1-S and R is above 196 V. If the voltage is below 196V, check the electric system or contact the energy supplier.</p> <p>If an error occurs during vehicle charging, try to reduce the set-up charging power and verify that the electric system is correctly dimensioned for the power drawn by the vehicle.</p>
321	Forbidden state change (IEC 61851-1)	<p>EV does not meet IEC 61851-1 standards for starting a charge session.</p> <p>Attempt a new charging session unplugging and reinserting the cable from both the charger and vehicle inlet.</p> <p>If the error persists, contact the vehicle manufacturer.</p>
	Display/LED stuck in Welcome mode (LED blinks red-green-blue)	Restart the charger from the circuit breaker, leaving the charger switched off for at least 60 seconds.
	LED or display does not light up at startup	
	The charger does not start	<p>Let the unit restart, it may take up to 30 seconds.</p> <p>Check if the circuit breaker is ON.</p> <p>Check that the CN1 cabling is correct.</p> <p>Check the voltage in CN1.</p> <p>Restart the charger from the circuit breaker, leaving the charger switched off for at least 60 seconds.</p>
	Cable stuck in the charger socket	Turn off the charger from the circuit breaker, then remove the cable.
	Suspended Charging with solid green LED/ message on the display. The charging session is suspended by the DPM or the EV. The session may resume.	<p>Verify that the max power in the DPM power limit section of the installer App is consistent with the contract power value in kW as indicated in the user's electricity contract. If the value is correct, wait for the charging session to resume or turn off some house loads.</p> <p>In the case of 3-ph installation, verify that the electrical loads are well balanced on the phases of the domestic system.</p>

	<p>App pairing does not complete after QR scan.</p>	<p>Check the integrity of the QR code on the label. Update the App to the latest version. Close and restart the App, then try again. Restart the charger from the circuit breaker, leaving the charger switched off for at least 60 seconds.</p>
--	---	---

6. CLEANING

Cleaning the outside of the device is always recommended when necessary and should be carried out using a soft damp cloth with a mild detergent. When finished, wipe off any traces of moisture or liquid with a soft dry cloth.



CAUTION: Avoid strong jets of air or water as well as the use of soaps or detergents that are too harsh and corrosive for the materials of the charger.

7. PACKAGING DISPOSAL



Dispose of packaging in an environmentally friendly manner. The materials used for packaging this product can be recycled and must be disposed of in compliance with the legislation in force in the country of use. The following disposal directions will be found on the packaging based on the type of material.



NOTE: Further information about current disposal facilities can be obtained from local authorities.

8. ASSISTANCE

If you have any questions about the installation of **eLuxWallbox**. For any other information or requests for support, please contact Free2move eSolutions S.p.A. through the relevant section of its website: www.esolutions.free2move.com.

9. DISCLAIMER

Free2move eSolutions S.p.A. will not be held responsible for any damage directly or indirectly caused to people, things or animals due to the failure to comply with all the provisions set out in this Manual, and the warnings regarding the installation and maintenance of **eLuxWallbox**.

Free2move eSolutions S.p.A. reserves all rights to this document, the article and the illustrations it contains. The reproduction, whole or in part, disclosure to third parties or use of its contents is prohibited without the prior written consent of Free2move eSolutions S.p.A.

Any information in this manual may be changed without prior notice and does not represent any obligation on the part of the manufacturer. Images in this manual are for illustrative purposes only and might differ from the delivered product.

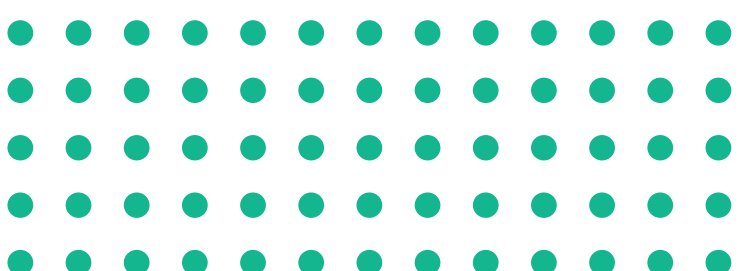

Registered office
Free2move eSolutions S.p.A.
 Piazzale Lodi, 3
 20137 Milan - Italy
www.esolutions.free2move.com

EN

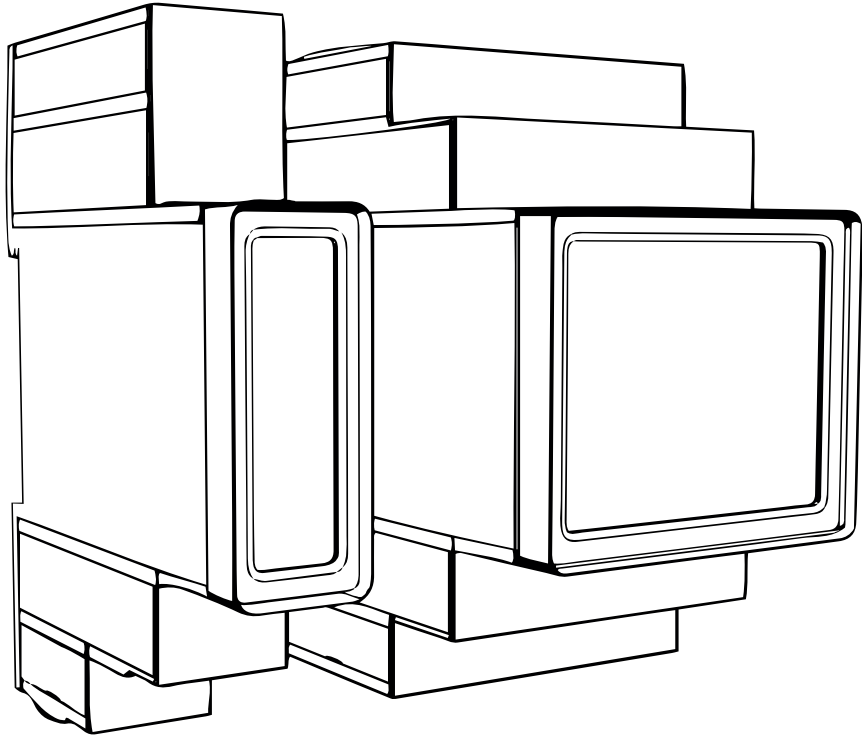
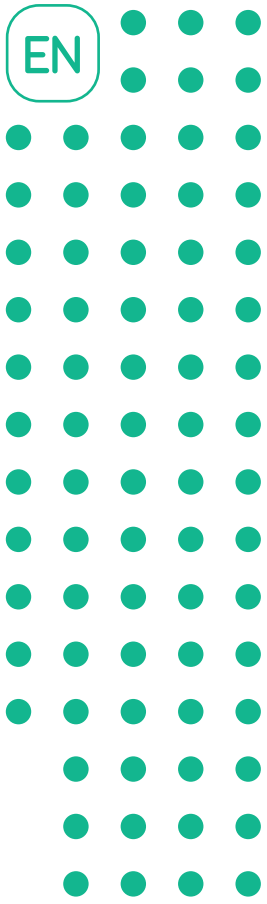

LuxWallbox

Accessories Manual



For safe and proper use,
follow these instructions.
Keep them for future reference

Table of content

1. INTRODUCTION	4
1.1. Purpose of the Manual	4
1.2. Identification of the Manufacturer.....	4
1.3. Structure of the Accessories Manual	4
1.4. Safety	5
1.5. Personal Protective Equipment (PPE).....	6
1.6. Warranty and delivery conditions	6
1.7. List of documents.....	7
1.8. Warnings	7
2. GENERAL INFORMATION	8
2.1. Fields of use	9
3. ACCESSORIES INSTALLATION	10
3.1. Installing PowerMeter (DPM).....	10
3.2. Installing MIDcounter	15
3.3. Communication cable installation	17
3.4. MIDcounter and PowerMeter (DPM) combined installation .	19
4. PowerMeter (DPM) and MIDcounter configuration.	22
4.1. Finder models.....	22
4.2. Gavazzi models.....	24
4.3. Device configuration summary	25
4.4. PowerMeter (DPM) and MIDcounter configuration on APP ..	26
4.5. PowerMeter (DPM) configuration	28
4.6. MIDcounter configuration.....	30
5. TROUBLESHOOTING.....	31
6. CLEANING.....	36
7. PACKAGING DISPOSAL	36
8. ASSISTANCE.....	37
9. DISCLAIMER.....	37



1. INTRODUCTION

1.1. Purpose of the Manual

This installation manual is a guide to help operators to work safely and carry out the installation operations needed to keep the charger in good working order.

The purpose of this document is to support qualified technicians who have received appropriate training, and demonstrated suitable skills and knowledge in the construction, installation, operation and maintenance of electrical equipment.

If the charger is used in a manner not specified in this manual, the protection provided by the charger may be impaired. This document contains the information required for the installation of the charger.

This document has been carefully checked by the Manufacturer Free2move eSolutions S.p.A. but oversights cannot be completely ruled out. If any errors are noted, please inform Free2move eSolutions S.p.A. Except for explicit contractual obligations, under no circumstances may Free2move eSolutions S.p.A. be held liable for any loss or damage resulting from the use of this manual, or from installation of the equipment. This document was originally written in English. In the event of any inconsistencies or doubts, please ask Free2move eSolutions S.p.A. for the original document.

1.2. Identification of the Manufacturer

The manufacturer of the charger is:

Free2move eSolutions S.p.A.

Piazzale Lodi, 3

20137 Milan – Italy

www.esolutions.free2move.com

1.3. Structure of the Accessories Manual





This manual is divided into chapters based on different topics and containing all the information that is needed to install the charger safely.

Each chapter is sub-divided into paragraphs which examine the fundamental points, and each paragraph may have its own title, along with sub-titles and a description.

1.4. Safety

This manual contains important safety instructions that must be followed during installation of the charger.

In order to fulfil this objective, this manual contains a number of precautionary texts, containing special instructions. These instructions are highlighted by a specific text box and are accompanied by a symbol, and are provided in order to ensure the safety of the personnel required to perform the operations described, and to avoid any damage to the charger and/or property:

	<p>This symbol means: DANGER</p> <p>This symbol is intended to highlight a dangerous situation for yourself and others. Read it carefully. Failure to comply with the instruction will result in an imminent hazardous situation which, if not avoided, will result in instant death, or serious or permanent injury.</p>
	<p>This symbol means: WARNING</p> <p>This symbol is intended to highlight safety information. Failure to comply with the instruction will result in a potentially hazardous situation which, if not avoided, could result in death or serious injury.</p>
	<p>This symbol means: CAUTION</p> <p>This symbol is intended to highlight safety information. Read it carefully. Failure to follow these instructions can result in death, serious injury or damage to equipment.</p>
	<p>This symbol means: NOTE</p> <p>Provides additional information to supplement instructions provided.</p>
	<p>This symbol means: NOTICE</p> <p>Provides instructions concerning the use of conduct necessary to handle the operations not associated with possible physical injuries.</p>

Installation must be carried out by qualified personnel. A dedicated, state-of-the-art electricity supply system must be designed and installed, and the system must be certified in compliance with local regulations and the energy supply contract.

Operators are required to read and fully understand this manual, and to comply strictly with the instructions it contains.

Free2move eSolutions S.p.A. cannot be held liable for damage caused to persons and/ or property, or to the equipment, if the conditions described in this document have not been complied with.





WARNING: Installation must be carried out in accordance with the regulations in force in the country of installation, and in compliance with all safety regulations for carrying out electrical work.

1.5. Personal Protective Equipment (PPE)

Personal Protective Equipment (PPE) means any equipment intended to be worn by the workers in order to protect them against one or more hazards likely to threaten their health or safety at the workplace, as well as any device or accessory intended for this purpose.

Since all the PPE indicated in this manual is intended to protect the personnel against health and safety hazards, the Manufacturer of the charger which is the subject of this manual recommends strict compliance with the indications contained in the various sections of this manual.

The list of PPE to be used in order to protect the operators against the residual risks present during the installation and maintenance interventions described in this document is provided below.

Symbol	Meaning
	Wear protective gloves
	Wear anti-static footwear



WARNING: It is responsibility of the operator to read and understand local regulations and evaluate the environmental conditions of the installation site in order to comply the need to wear additional PPE.

1.6. Warranty and delivery conditions

The warranty details are described in the Terms and Conditions of Sale included with the purchase order for this product and/or in the packaging of the product.

Free2move eSolutions S.p.A. assumes no responsibility for failure to comply with the instructions for proper installation, and cannot be held responsible for systems upstream or downstream of the equipment supplied.

Free2move eSolutions S.p.A. cannot be held responsible for defects or malfunctions deriving from: improper use of the charger; deterioration due to transport or particular environmental conditions or installation by unqualified persons.

Free2move eSolutions S.p.A. is not responsible for any disposal of the equipment, or parts thereof, that does not comply with the regulations and laws in force in the country of installation.



NOTICE: Any modification, manipulation or alteration of the hardware or software not expressly agreed with the manufacturer will immediately void the warranty.

1.7. List of documents

In addition to this manual, product documentation can be viewed and downloaded by visiting: www.esolutions.free2move.com.

1.8. Warnings



DANGER: Risk of electric shock and fire. Installation must be carried out in accordance with the regulations in force in the country of installation, and in compliance with all safety regulations for carrying out electrical work.

- Before installing or using the device, make sure that none of the components have been damaged. Damaged components can lead to electrocution, short circuits, and fire due to overheating. A device with damage or defects must not be used.
- Install **eLuxWallbox** away from petrol cans or combustible substances in general.
- Before installing **eLuxWallbox compatible accessories**, ensure the main power source has been disconnected.
- The **eLuxWallbox compatible accessories** must only be used for the specific applications they are designed for.
- Installation not carried out correctly may pose risks to the user.
- The charger must be connected to a mains network in compliance with local and international standards, and all the technical requirements indicated in this manual.
- Children or other persons not able to gauge risks related to the installation of the charger could suffer serious injury or put their lives at risk.
- Pets or other animals must be kept away from the device and packaging material
- Children must not play with the device, accessories or packaging provided with the product.
- The only part that can be removed from **eLuxWallbox**, is the removable cover. Access under the cover is only permitted by qualified personnel during installation, dismantling or maintenance.
- **eLuxWallbox** can only be used with an energy source.
- Necessary precautions to ensure safe operation with Active Implantable Medical Devices must be taken. To determine whether the charging process could adversely affect the medical device, please contact its manufacturer.

2. GENERAL INFORMATION

eLuxWallbox is an Alternate Current charging solution for powering electric vehicles and hybrid plug-ins, and is ideal for semi-public and residential use. The charger is available in three-phase or single-phase configurations and is equipped with a Type 2 socket.

The charger charges electric vehicles up to 22 kW in three-phase, or up to 7.4 kW in single-phase. The charger includes connectivity options such as remote monitoring via the eSolutions control platform (CPMS). Its final configuration must be completed using the **PowerUp** application. For the end user, the **eLuxWallbox** can be managed via the dedicated user's eSolutions Charging App. Both applications are available on Google Play™ and Apple Store®.

This charger is equipped with a SIM card for connection to the 4G mobile network.

The SIM card is automatically activated the first time the charger is turned on.

This document describes how to install the external accessories compatible with the **eLuxWallbox**.

The external accessories described in this manual are:

- **PowerMeter (DPM)**: an energy meter that enables the Dynamic Power Management (**DPM**) which is a smart function that allows an electric vehicle to be recharged using only the power available at home, modulating the charging power and avoiding unpleasant blackouts.
- **MIDcounter**: a certified energy meter that allows to monitor the consumption of the **eLuxWallbox** during each charging session.

This manual contains a description of the characteristics of the different accessories, information on models, installation process and final configuration of the devices.

The **eLuxWallbox** is configured to be used with the following electrical accessories: **PowerMeter (DPM)** or **MIDcounter**:

- Gavazzi, 1-phase, Direct, 32 A
- Finder, 1-phase, Direct, 40 A
- Gavazzi, 3-phase, Direct, 65 A
- Finder, 3-phase, Direct, 80 A

PowerMeter (DPM):

- Gavazzi, 1-phase, Indirect with 1x CT 100 A
- Gavazzi, 1-phase, Indirect with 1x CTV 60 A
- Gavazzi, 3-phase, Indirect with 3x CT 150 A



WARNING: Do not try to install the Electrical Accessories if you are not qualified as a professional electrician. To do so could cause serious danger and harm to you and to the people, property or animals around you.

To complete the installation, it is necessary to configure the **eLuxWallbox** through the dedicated apps:

	Installer's app: PowerUp
Product versions (EU):	EPRO23S224GWBAX
Product versions (UK):	EPRO23S224GWBAS



WARNING: Only Electrical Accessories suggested by Free2move eSolutions S.p.A. are compatible. Installation must be performed by qualified personnel in accordance with local regulations.

2.1. Fields of use

Free2move eSolutions S.p.A. declines all liability for any damage whatsoever due to incorrect or careless actions.

The charger may not be used for any purpose other than the one it is intended to fulfill.

The equipment must not be used by children or people with limited mental or physical abilities, or even by adults or expert professionals if the charger undergoes operations that do not comply with this manual and accompanying documentation.

The charger is a charging device for electric vehicles; the following classification (according to IEC 61851-1) identifies its characteristics:

- Power supply: permanently connected to the AC power supply grid
- Output: Alternate Current
- Environmental conditions: indoor / outdoor use
- Fixed installation
- Protection against electric shock: Class I
- EMC Environment classification: Class B
- Charging type: Mode 3 according to the IEC 61851-1 standard
- Optional function for ventilation not supported

3. ACCESSORIES INSTALLATION

To install the electrical accessories, it is necessary to use Modbus communication cables with the following characteristics:

- Modbus RS485 twisted STP 2x2 AWG24 or S/FTP cat.7 suitable for installation with a 400V power line
- Conductor size: 0.5 mm²
- Stripping length: 10 mm
- Recommended maximum length: 150 m

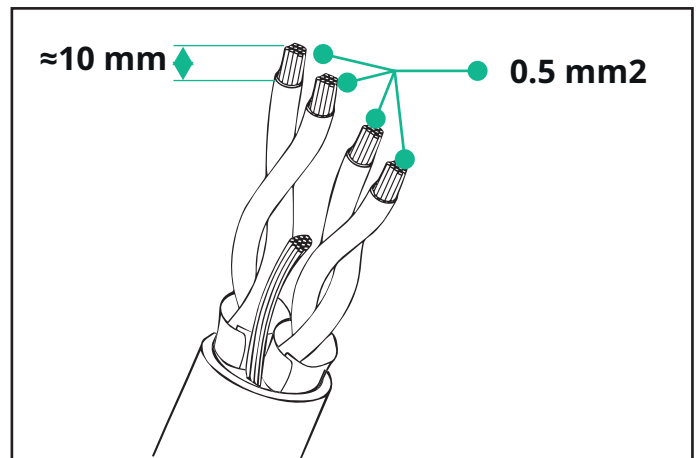

3.1. Installing PowerMeter (DPM)

PowerMeter (DPM) is an energy meter that enables the Dynamic Power Management (**DPM**) which is a smart function that allows an electric vehicle to be recharged using only the power available at home, modulating the charging power and avoiding unpleasant blackouts. Whenever other appliances are being used during the charging session, the system can modulate the charging power towards the car, even temporarily suspending the charging session. As soon as the other domestic appliances are switched off, the session will resume.

The **DPM** smart logic works both in three-phase and in single-phase installations.



WARNING: When installing in three-phase systems, make sure that the electrical loads (including the wallbox) are well balanced between the phases of the electrical system.



WARNING: Before carrying out any installation or maintenance work on the device, it must be ensured that the power supply is switched off.

For Direct models of the PowerMeter (DPM):

Place the **PowerMeter (DPM)** after the main utility meter. The **PowerMeter (DPM)** must measure all the electrical loads, including the **eLuxWallbox**.

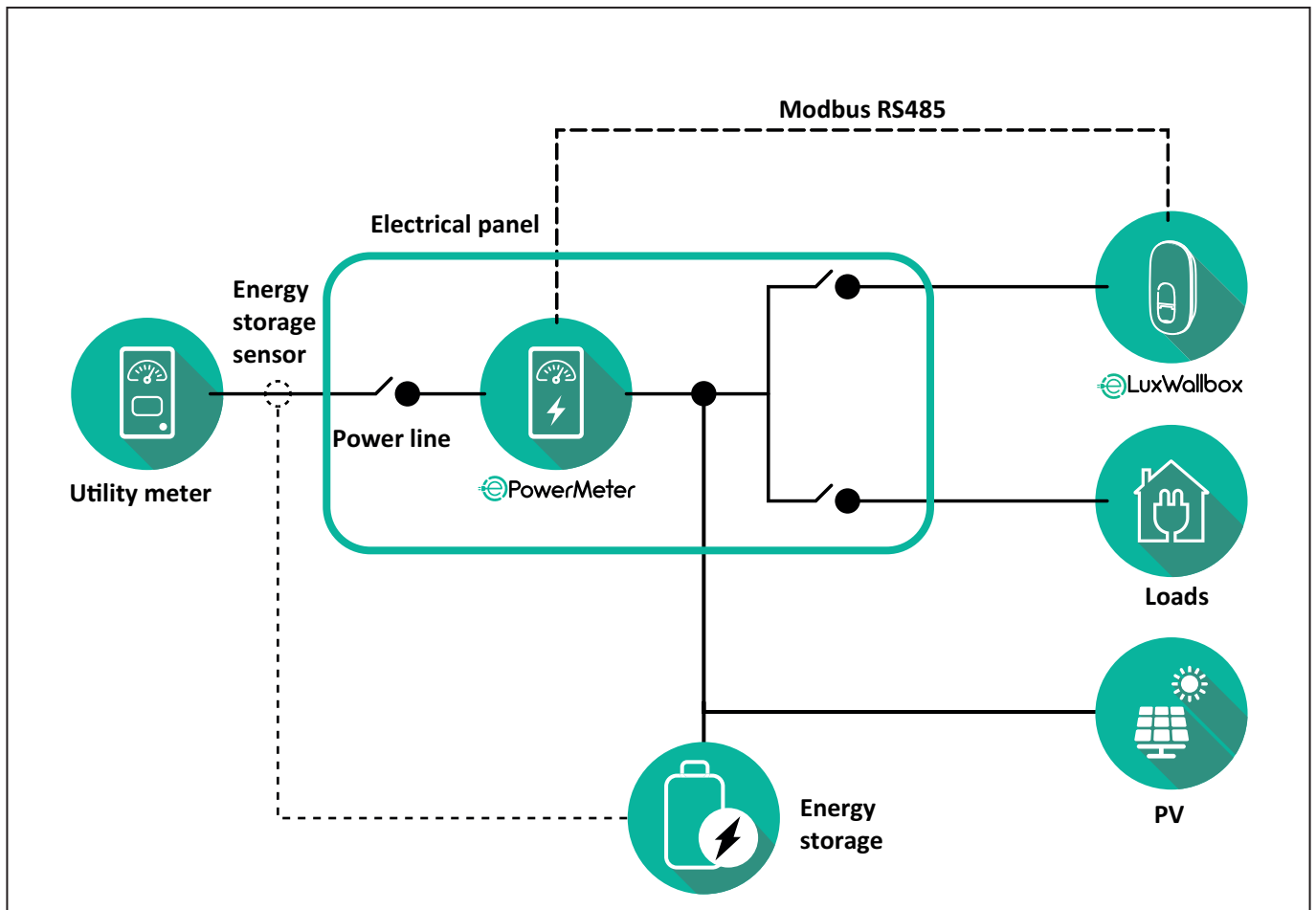

For Direct models of the PowerMeter:



WARNING: During the installation always refer to the manufacturer installation manual provided with the meter.



NOTE: For the single-phase or three-phase electrical connection of the Direct **PowerMeter**, please refer to the diagrams below.

Finder model 1ph and 3ph

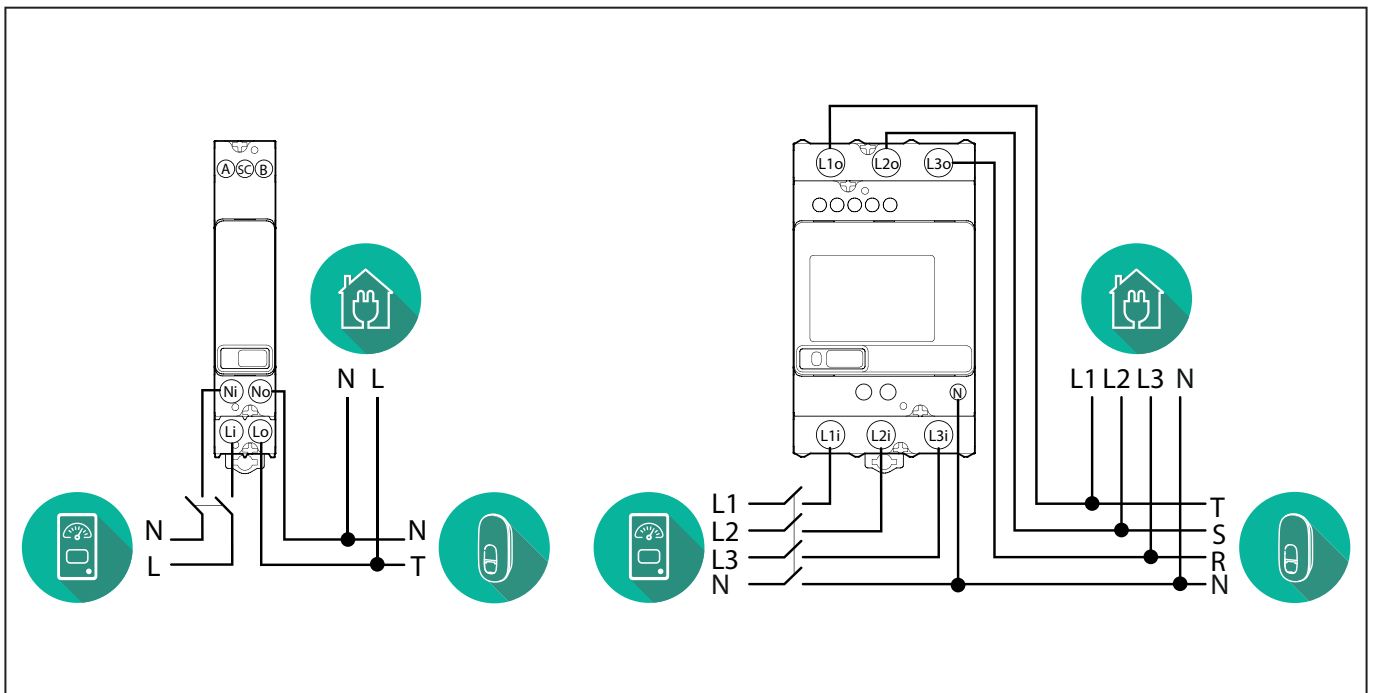

Gavazzi model 1ph and 3ph

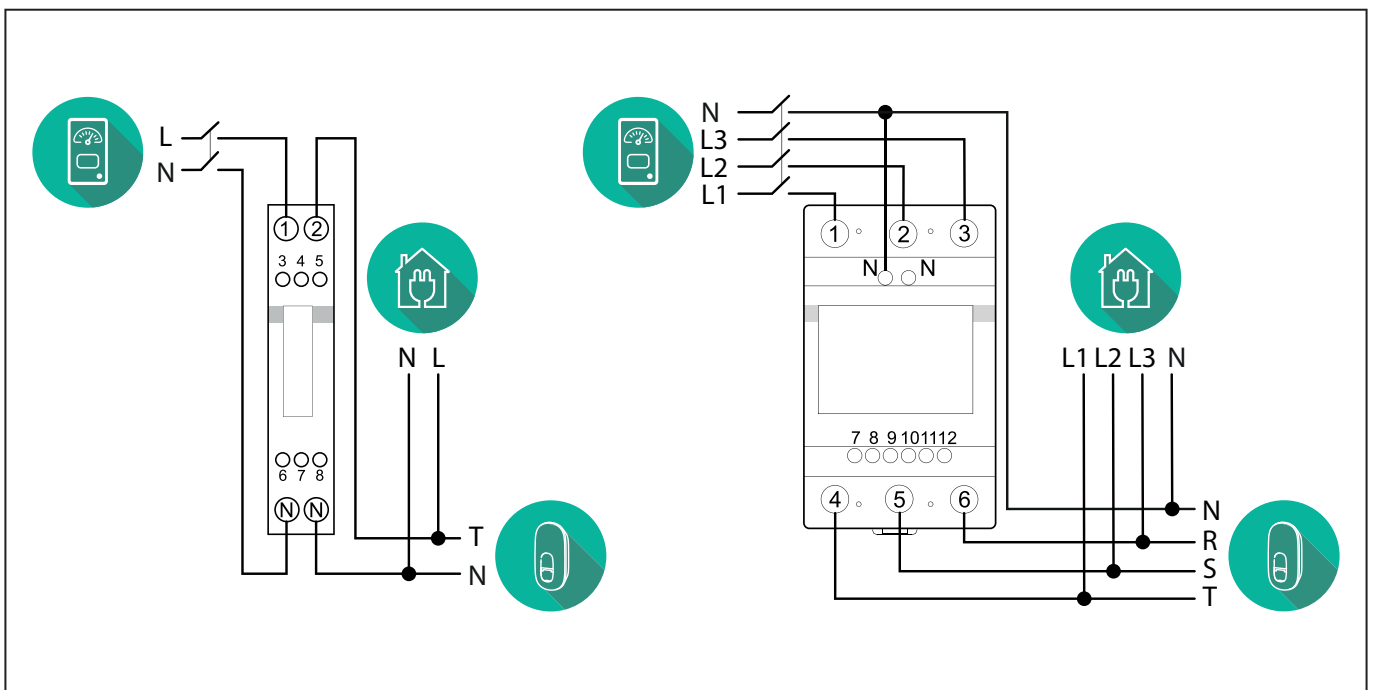

NOTICE:



1) If PV is present, the **PowerMeter** should be placed between the Utility Meter and the PV connection point.

2) If there is a home Energy storage, the **PowerMeter** should be placed between the Energy storage connection point and the Energy storage measurement sensor.

For Indirect models of the PowerMeter:

Place the CT (current transformer) of the **PowerMeter** after the main utility meter and before the main switch of the house/building. The current transformer must measure all the domestic loads, including the **eLuxWallbox**.

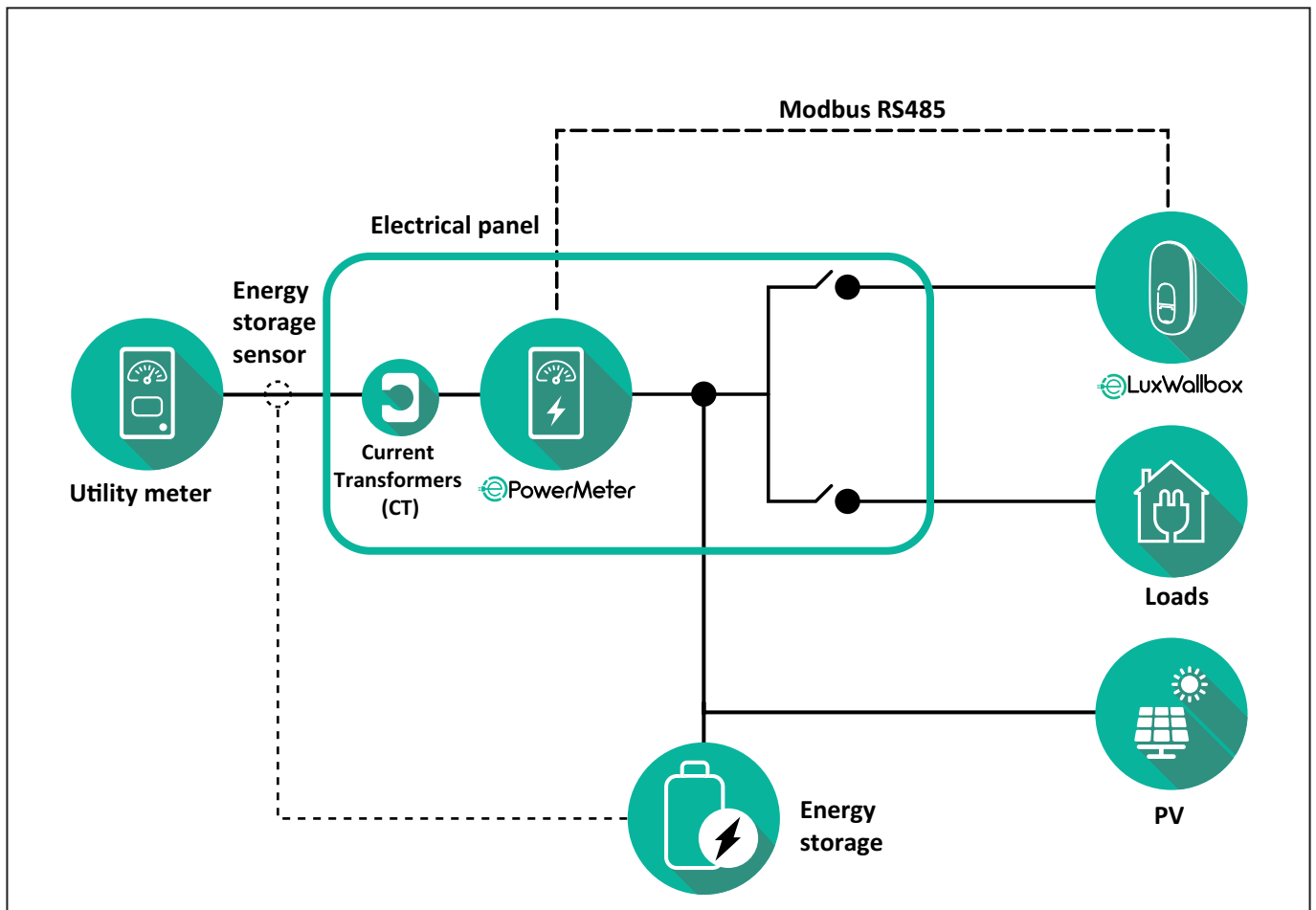

NOTICE:



1) If PV is present, the **PowerMeter** Current Transformers (CT) should be placed between the PV connection point and the Utility Meter.

2) If there is a home Energy storage, the **PowerMeter** Current Transformers (CT) should be placed between the Energy storage connection point and the Energy storage measurement sensor.

Connect the Current Transformers (CT) as indicated in the meter installation manual. Point the arrow on the CT in the direction of the loads.

For the three-phase or single-phase electrical connection of the indirect **PowerMeter**, refer to the diagrams below.

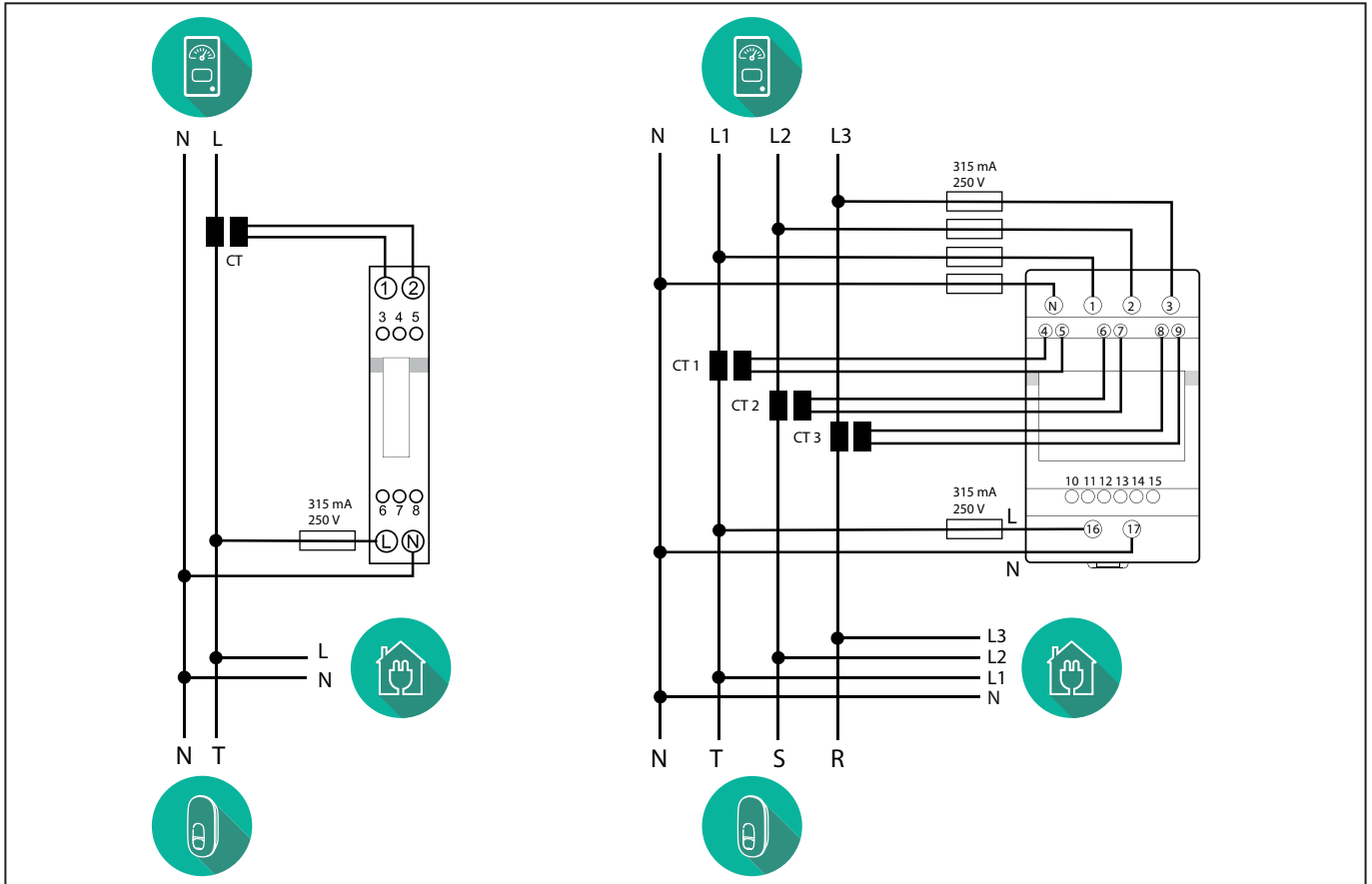

3.2. Installing MIDcounter

The **MIDcounter** is a certified energy meter that allows the consumption of the charger to be safely and reliably monitored during each charging session.

All the relevant data of the charging sessions is automatically recorded by a certified **MID** meter and transferred from the charger to the Charge Point Management System (CPMS).



WARNING: The power to the charger must remain off during this step.

Place the **MIDcounter** on the same power line as the charger, after the electrical protection devices.

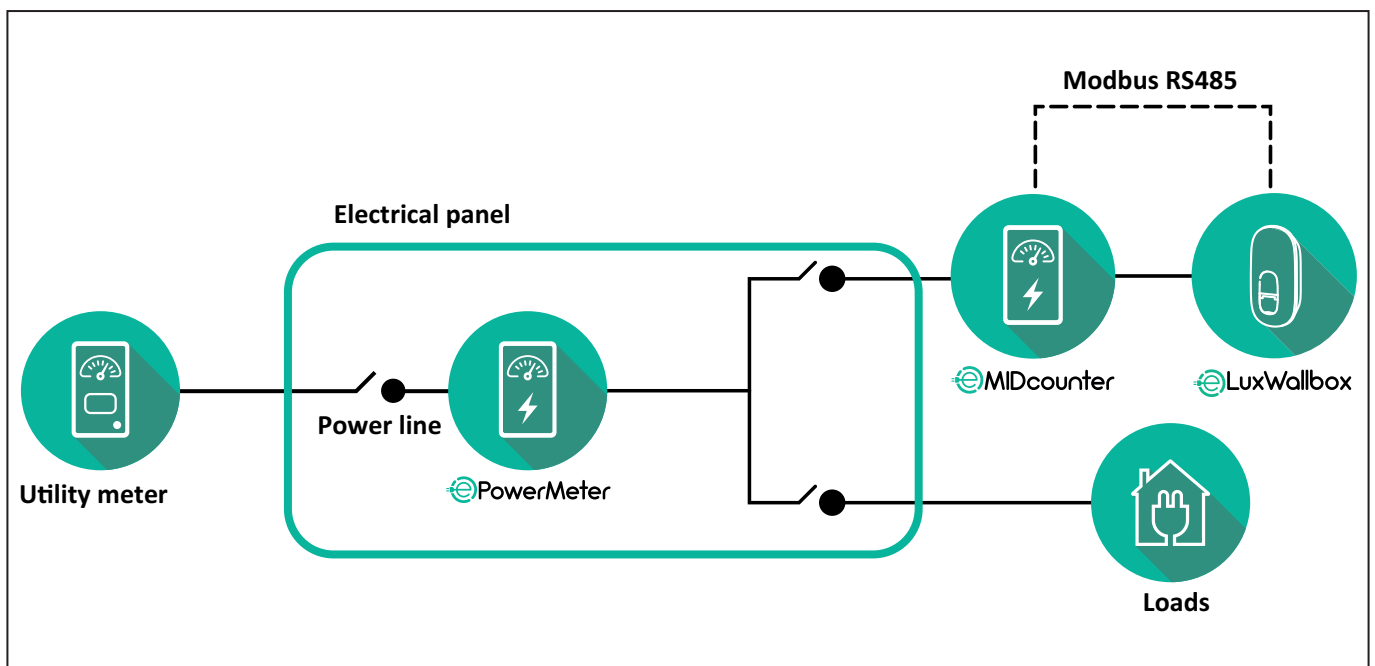

See the diagrams below for single phase and three phase electrical connection of **MIDcounter** (Finder and Gavazzi).

**Finder 1-phase, Direct, 40 A
(7M2482300210)**

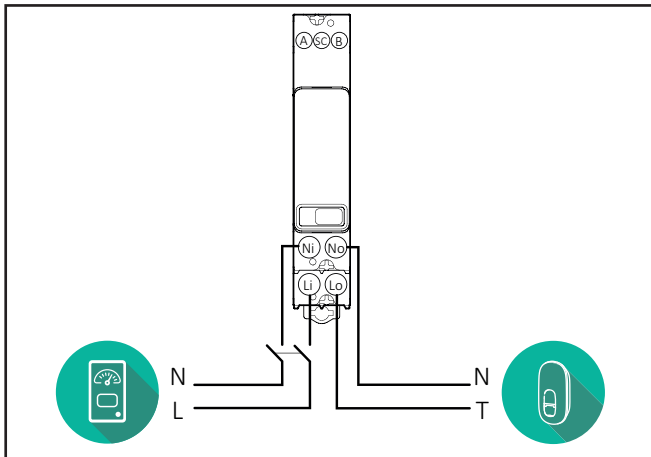

**Gavazzi, 3-phase, Direct, 65 A
(EM340DINAV23XS1PFB)**

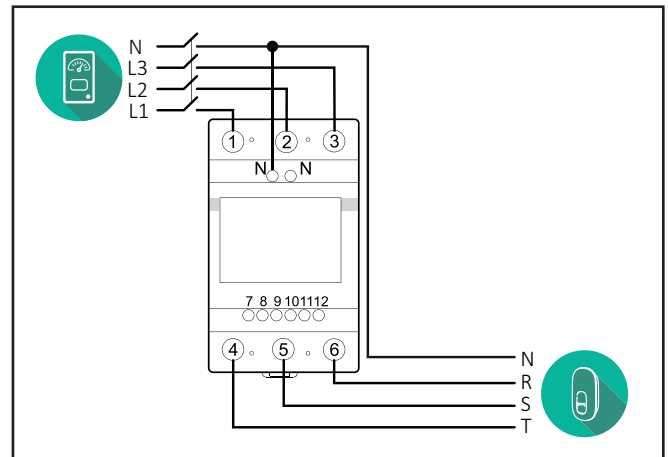

**Finder 3-phase, Direct, 80 A
(7M3884000212)**

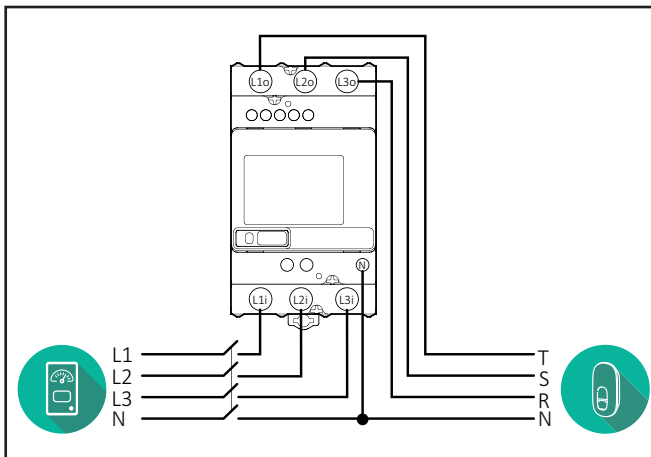

**Gavazzi, 1 phase, Direct, 100 A
(EM112DINAV01XS1PFB)**

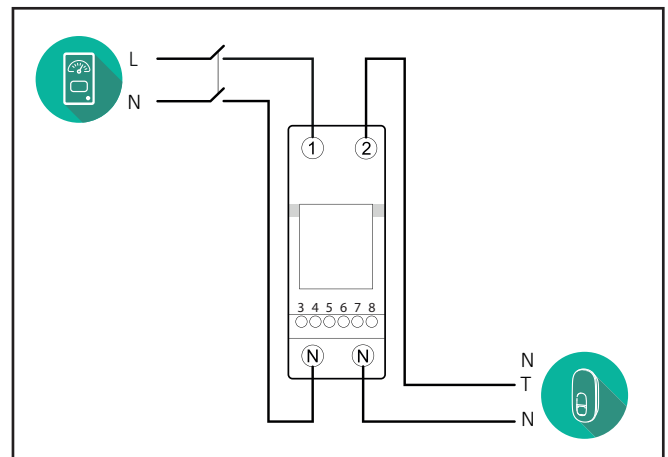

**Gavazzi, 1-phase, Direct, 32 A
(EM111DINAV81XS1PFB)**

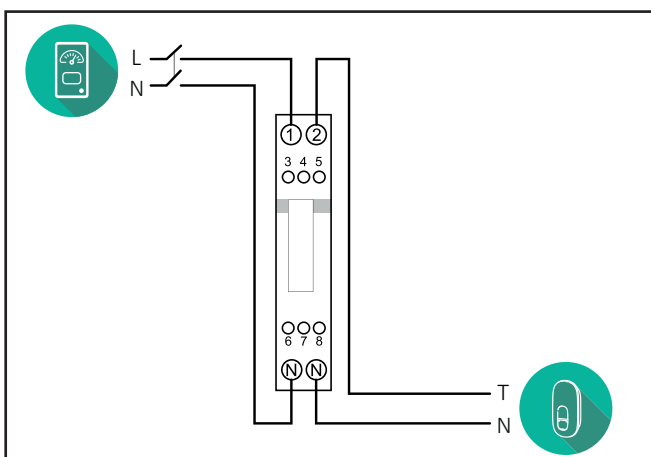

3.3. Communication cable installation

Install a communication cable between the **PowerMeter (DPM)** and the **eLuxWallbox**.

- On the **eLuxWallbox**, remove the protective cap of the communication cables entry point and insert the \varnothing 25 mm corrugated sheath.
- Tighten the box-cable sheath junction.
- Insert the communication cable, pulling it to a suitable length so that it reaches the communication port CN12, leaving some slack.
- Connect the Modbus RS485 communication cable to the GND, - and + pins of the CN12 connector.



NOTE: It is possible to replace the box-cable sheath junctions with \varnothing 25mm cable gland (not provided by the manufacturer).

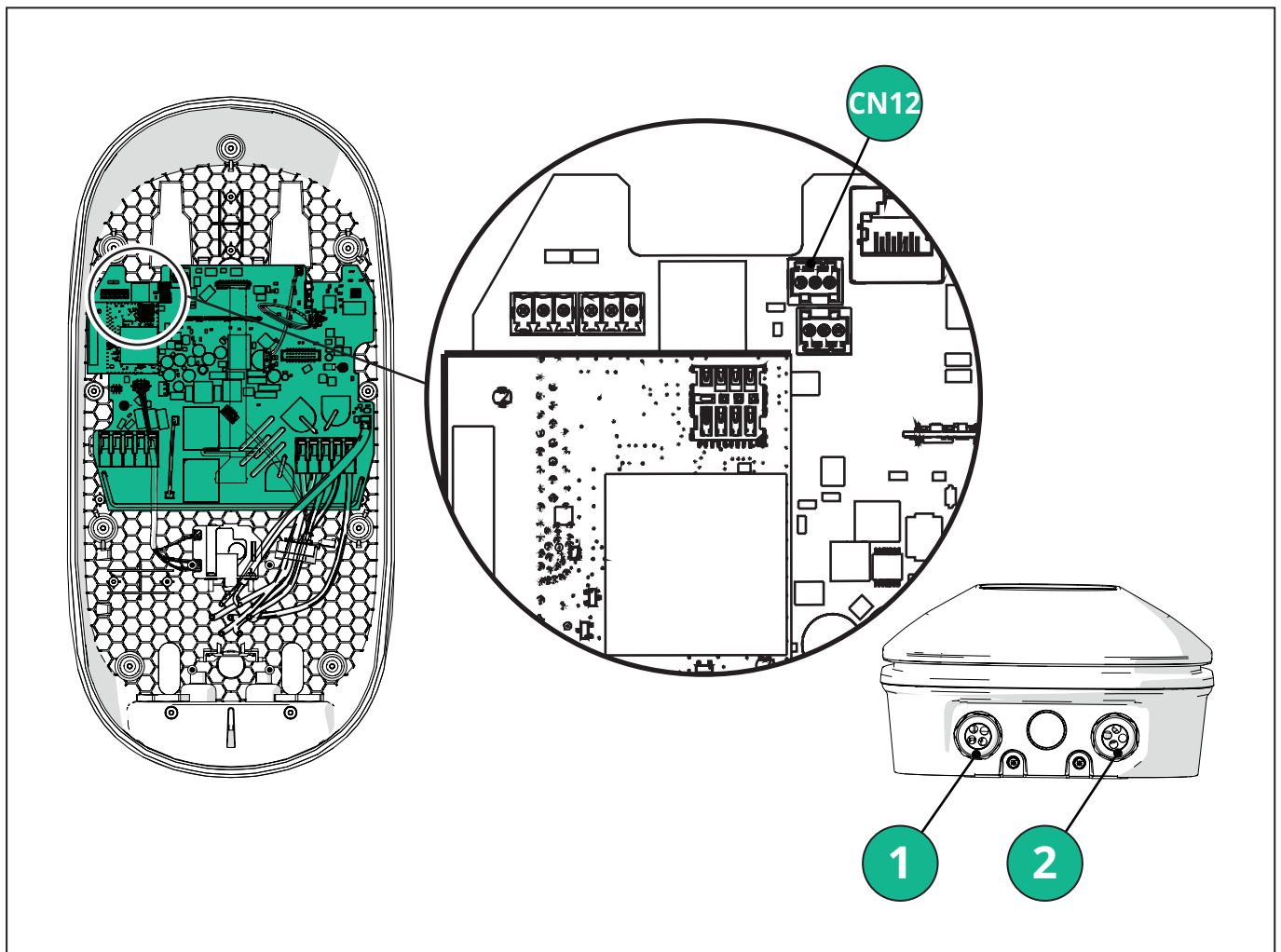

1 - Power supply cables

2 - Communication cables

CN12 - RS485 Modbus for external meter communication (**DPM** and **MID**)

Connect the communication cables in the following order from the **PowerMeter (DPM)** to **eLuxWallbox**.



WARNING: If the installation includes both accessories, follow the instructions for “MIDcounter and PowerMeter (DPM) combined installation”.

CN12	Finder 1ph 7M.24.8.230.0210
GND	SC
-	B
+	A

CN12	Gavazzi 3ph EM340DINAV23XS1PFB
GND	10
-	9
+	8

Junction 9/7

CN12	Finder 3ph 7M.38.8.400.0212
GND	SC
-	B
+	A

CN12	Gavazzi Ind 1ph EM111DINAV51XS1X / EM111DINMV51XS1X
GND	7
-	8
+	6

Junction 8/5

CN12	Gavazzi 1ph EM111DINAV81XS1PFB
GND	7
-	8
+	6

Junction 8/5

CN12	Gavazzi Ind 3ph EM330DINAV53HS1X
GND	13
-	12
+	11

Junction 12/10

3.4. MIDcounter and PowerMeter (DPM) combined installation

If installing both electrical accessories, the positioning of **MIDcounter** together with the **PowerMeter (DPM)** is indicated in the diagram below:

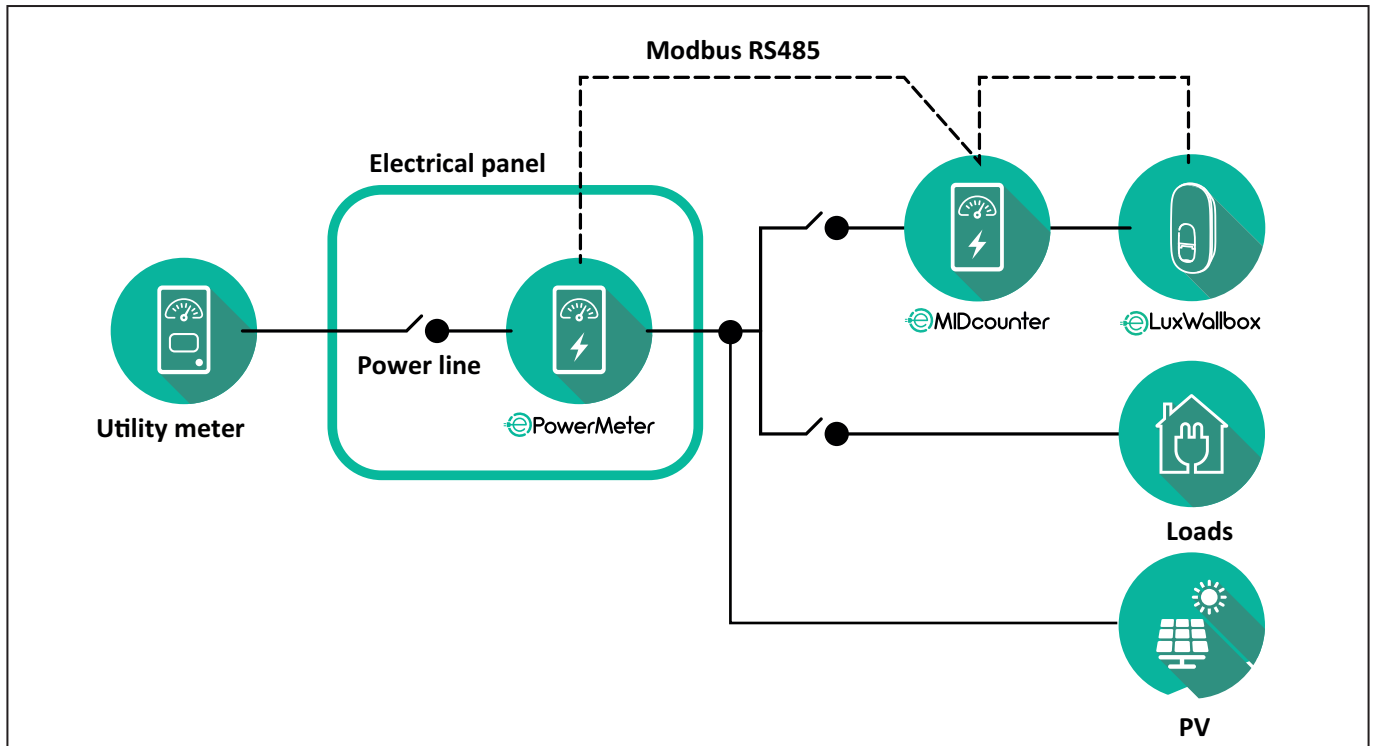

Connect the Modbus communication cables. The **PowerMeter (DPM)**, **MIDcounter** and the **eLuxWallbox** must be connected on the same communication bus in a Daisy chain format.

On the **eLuxWallbox**:

- Remove the protective cap of the communication cable entry point and insert the \varnothing 25 mm corrugated sheath.
- Tighten the box-cable sheath junction.
- Insert the communication cable, pulling it to a suitable length so that it reaches the communication port CN12, leaving some slack.
- Connect the Modbus RS485 communication cable to the GND, - and + pins of the CN12 connector.

Use the table below to connect the communication cables from the accessories to the **eLuxWallbox**.

Single-Phase.

PowerMeter (DPM)	MIDcounter	eLuxWallbox
EM111DINAV51XS1X - EM111DINMV51XS1X	EM111DINAV81XS1PFB	CN12
GND (7)	GND (7)	GND
A- (8) / T*(5)	A- (8)	-
B+ (6)	B+ (6)	+
EM111DINAV51XS1X - EM111DINMV51XS1X	7M 24.8.230.0210	CN12
GND (7)	SC	GND
A-(8) / T*(5)	B-	-
B+ (6)	A+	+
EM111DINAV81XS1PFB	EM111DINAV81XS1PFB	CN12
GND (7)	GND (7)	GND
A-(8) / T*(5)	A- (8)	-
B+ (6)	B+ (6)	+
EM111DINAV81XS1PFB	7M 24.8.230.0210	CN12
GND (7)	SC	GND
A-(8) / T*(5)	B-	-
B+ (6)	A+	+
7M 24.8.230.0210	EM111DINAV81XS1PFB	CN12
SC	GND (7)	GND
B-	A- (8)	-
A+	B+ (6)	+
7M 24.8.230.0210	7M 24.8.230.0210	CN12
SC	SC	GND
B-	B-	-
A+	A+	+

Three-Phase.

PowerMeter (DPM)	MIDcounter	eLuxWallbox
EM330DINAV53HS1X	EM340DINAV23XS1PFB	CN12
GND (13)	GND (10)	GND
A-(12) / T*(10)	A-(9)	-
B+ (11)	B+ (8)	+
EM330DINAV53HS1X	7M.38.8.400.0212	CN12
GND (13)	SC	GND
A-(12) / T*(10)	B-	-
B+ (11)	A+	+
EM340DINAV23XS1PFB	EM340DINAV23XS1PFB	CN12
GND (10)	GND (10)	GND
A-(9) / T*(7)	A-(9)	-
B+ (8)	B+ (8)	+
EM340DINAV23XS1PFB	7M.38.8.400.0212	CN12
GND (10)	SC	GND
A-(9) / T*(7)	B-	-
B+ (8)	A+	+
7M.38.8.400.0212	EM340DINAV23XS1PFB	CN12
SC	GND (10)	GND
B-	A-(9)	-
A+	B+ (8)	+
7M.38.8.400.0212	7M.38.8.400.0212	CN12
SC	SC	GND
B-	B-	-
A+	A+	+

*A 120 Ω terminating resistor must be installed on the devices at the ends of the Modbus chain. The resistor is present by default in the **eLuxWallbox**. Gavazzi models have a built-in resistor, which can be enabled by making a jumper between these terminals.

4. PowerMeter (DPM) and MIDcounter configuration

Power on the **PowerMeter (DPM)** and/or the **MIDcounter** when the electrical installation and communication installation are complete. Then proceed with the configuration on the display of the meters.

The configuration varies depending on the model.

4.1. Finder models

The following actions help to understand how to set Finder energy meters:

- Press the touchscreen button (a,b) to move between menus and parameters;
- Long press (~ 2 seconds) the touchscreen button (a,b) to enter and confirm selections

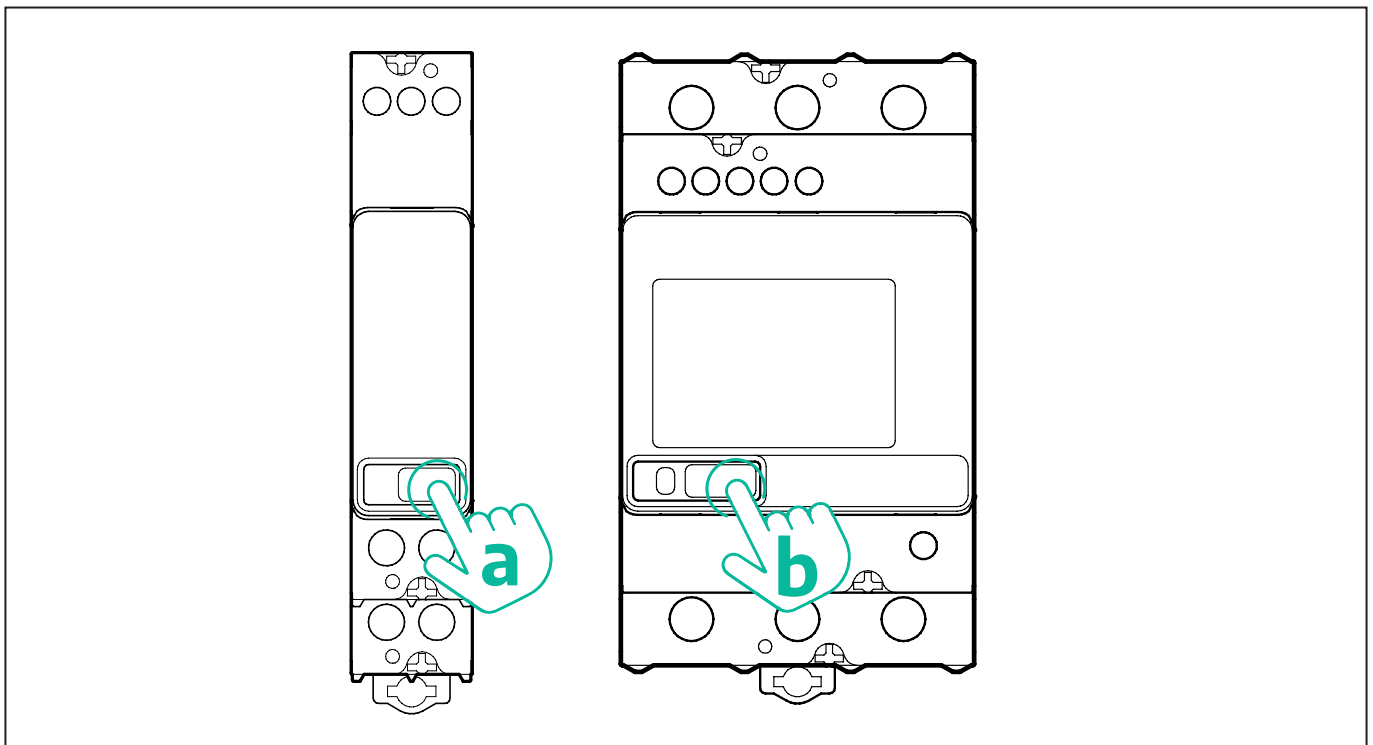

Follow the next steps to correctly configure the single-phase or three-phase Finder energy meters:

- When powering up the energy meter for the first time, long press the touchscreen button (a,b) until the display text blinks in order to enter the "MAIN" menu;
- Scroll the "MAIN" menu pressing the touchscreen button (a,b), then select "SETTING" ("SET" on single-phase meter). Long press to enter the selection.
- Scroll the "SETTING" menu pressing the touchscreen button (a,b), then select "COMMUNICATION" ("COMM" on single phase meter). Long press to enter the selection.
- Insert the correct values indicated in the table below. To modify the value press the touchscreen button (a,b), long press to confirm.

Only for three-phase Finder meter (in addition to previous options):

- Long press the touchscreen button (a,b) until the display text blinks in order to enter the "MAIN" menu (or return to the "MAIN" menu)
- Scroll the "MAIN" menu pressing the touchscreen button (a,b), then select "INSTALLATION". Long press the touchscreen button (a,b) to enter the selection
- Scroll the "INSTALLATION" menu pressing the touchscreen button (a,b) and then select the following option
 - "Communication mode" = "3L+N, L+N-Arithmetic"
 - Once the correct option is confirmed, enter the password: "DCBA" **Attention:** configuration cannot be modified after entering the password **DCBA**
 - Confirm the change selecting "Yes" when prompted.

ALL FINDER MODELS	PowerMeter (DPM)	MIDcounter
DEVICE ADDRESS	1	2
BITS PER SECOND (BAUD)	38400 bit/s	38400 bit/s
PARITY	Even	Even
STOP BIT	1	1
Additional for three-phase type		
	PowerMeter (DPM)	MIDcounter
COMMUNICATION MODE	3L+N, L+N-Arithmetic	3L+N, L+N-Arithmetic
PASSWORD	DCBA	DCBA

4.2. Gavazzi models

The following actions help to understand how to set Gavazzi energy meters:

- Press the touchscreen buttons (c, d, e, g) to move between menus and values
- press (~ 2 seconds) the touchscreen button (d, f) to enter the menu and confirm selections

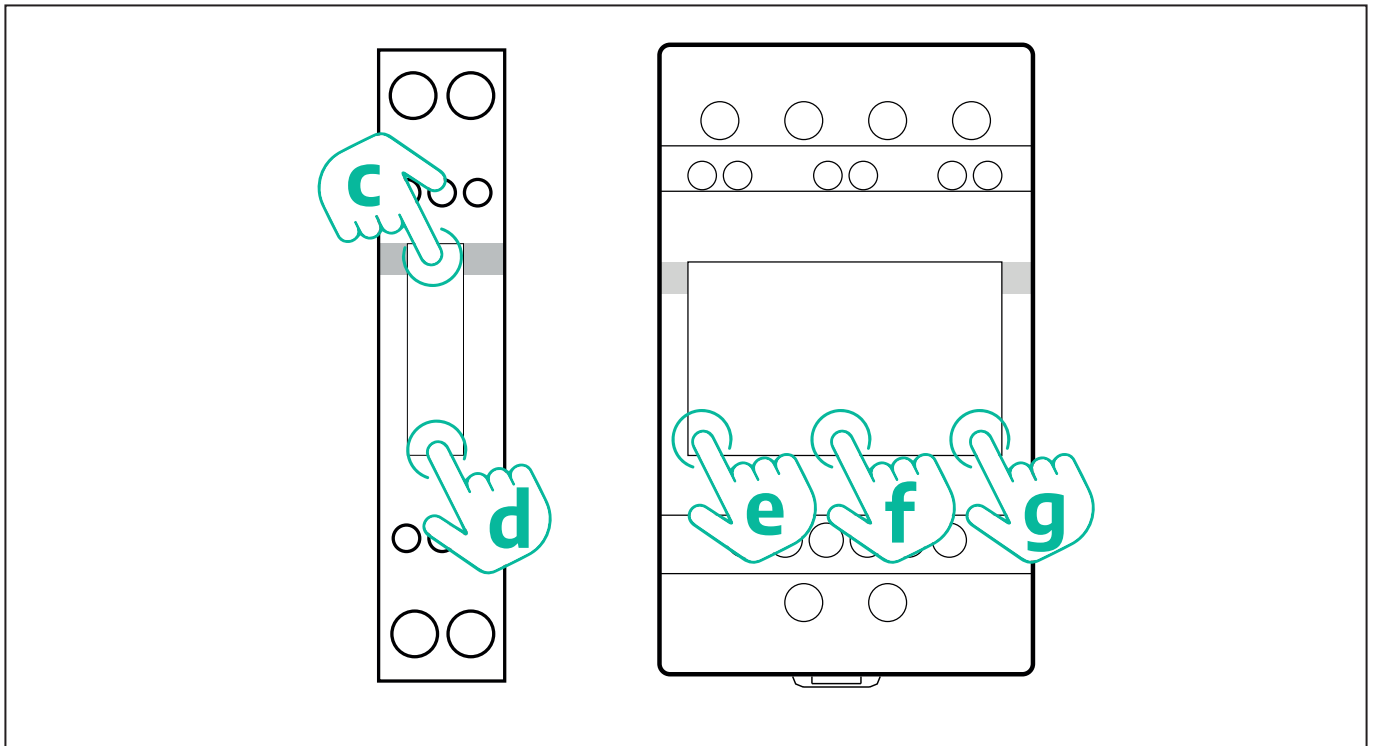

Follow the next steps to correctly configure the single-phase Gavazzi direct and indirect energy meters.

- When powering up the energy meter for the first time, long press the touchscreen button (d) until the password appears on the screen
- Long press the buttons (c, d) simultaneously in order to confirm the password "0000" and enter the "MAIN" menu
- Scroll the "MAIN" menu pressing the upper button (c) and then select the following options in the table below

Follow the next steps to correctly configure the three-phase Gavazzi direct and indirect energy meters:

- When powering up the energy meter for the first time, long press the central button (f) until the password appears on the screen;
- Long press the buttons (e, g) simultaneously in order to confirm the password "0000" and enter the "MAIN" menu
- Scroll the "MAIN" menu pressing the buttons (e or g) and then select the options in the table below

ALL GAVAZZI MODELS	PowerMeter (DPM)	MIDcounter
PASS	0000	0000
ADDRESS	001	002
BAUD	38.4	38.4
PARITY	Even	Even
Additional for three-phase type		
	PowerMeter (DPM)	MIDcounter
SYSTEM	3Pn	3Pn
ADDRESS	001	002

4.3. Device configuration summary

EM340DINAV23XS1PFB / EM330DINAV53HS1X		EM340DINAV23XS1PFB	
PASS	0000	PASS	0000
SYSTEM	3Pn	SYSTEM	3Pn
ADDRESS	1	ADDRESS	2
BAUD	38.4	BAUD	38.4
PARITY	EVEN	PARITY	EVEN

EM111DINAV81XS1PFB / EM111DINAV51XS1X / EM111DINMV51XS1X		EM111DINAV81XS1PFB	
PASS	0000	PASS	0000
ADDRESS	001	ADDRESS	002
BAUD	38.4	BAUD	38.4
PARITY	EVEN	PARITY	EVEN

7M 24.8.230.0210		7M 24.8.230.0210	
DEVICE ADDRESS	__ 1	DEVICE ADDRESS	__ 2
BITS PER SECOND (BAUD)	38400 bit/s	BITS PER SECOND (BAUD)	38400 bit/s
PARITY	EVEN	PARITY	EVEN
STOP BIT	1	STOP BIT	1

7M.38.8.400.0212		7M.38.8.400.0212	
DEVICE ADDRESS	__ 1	DEVICE ADDRESS	__ 2
BITS PER SECOND (BAUD)	38400 bit/s	BITS PER SECOND (BAUD)	38400 bit/s
PARITY	EVEN	PARITY	EVEN
STOP BIT	1	STOP BIT	1
CONNECTION MODE	3L+N, L+N - Arithmetic	CONNECTION MODE	3L+N, L+N - Arithmetic
PASSWORD	DCBA	PASSWORD	DCBA

4.4. PowerMeter (DPM) and MIDcounter configuration on APP

To complete installation, the final configuration of the **eLuxWallbox** and its accessories should be set via the dedicated app

PowerUp is a smartphone app for qualified installers only, available via Google Play™ and Apple Store®. The configuration is carried out via a Bluetooth connection. The wallbox cannot operate correctly if not configured via the app.



NOTICE: Make sure you have the latest version of PowerUp to have access to all of the features.

Follow the instructions below to get started with the app:

Download PowerUp to your smartphone and activate Bluetooth on the smartphone.



Scan **eLuxWallbox** QR code to pair it with the app. The QR Code can be found on the side of the charger.

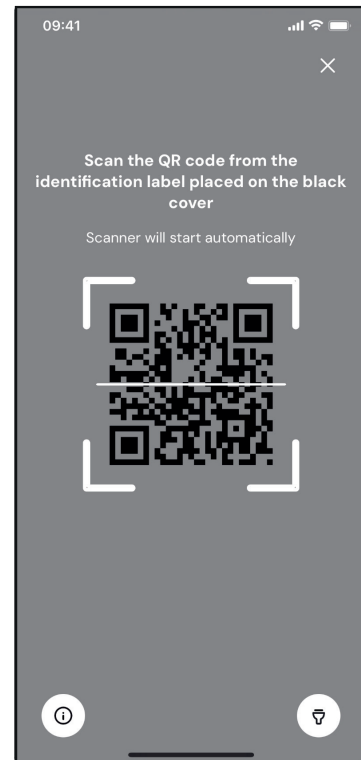

Once paired, complete the configuration set up of **eLuxWallbox** and its Accessories by clicking on the parameter to be configured.

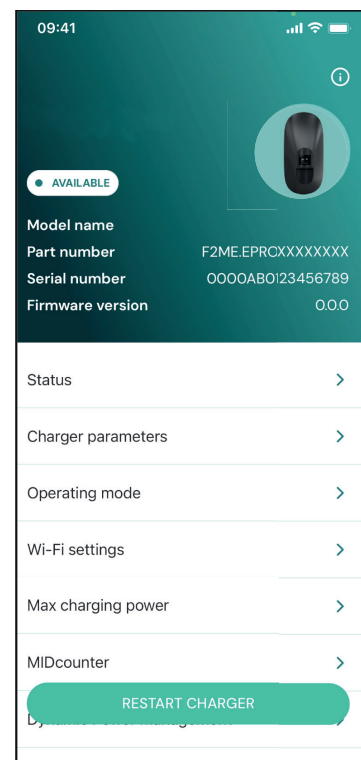

4.5. PowerMeter (DPM) configuration

To complete installation of the **PowerMeter (DPM)**, follow the steps below:

Select "**DPM PowerMeter**" on the homepage

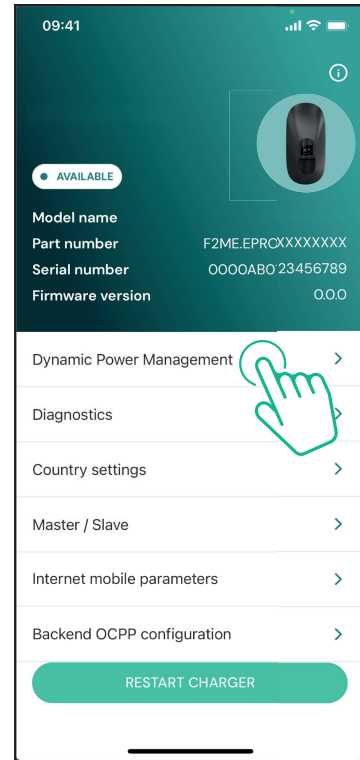

Select the **PowerMeter** type from the drop-down menu, matching the model installed.

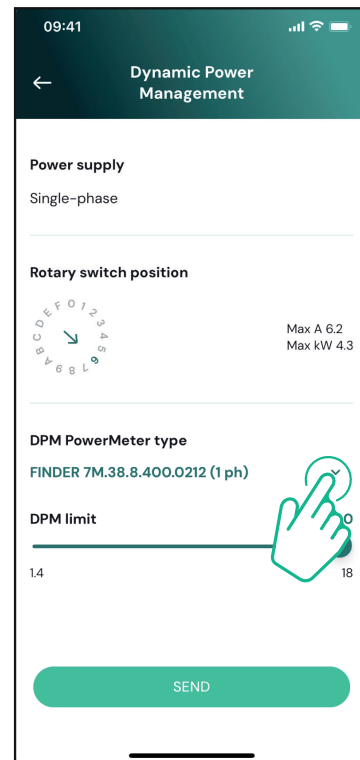

Enter the value of the user contractual power as **DPM** power limit.

For Indirect Meter only - Set the CT current ratio with the slider.

- With CTV 60 A set 60 as Current ratio
- With CTA 100 A set 20 as Current ratio
- With CTA 150 A set 30 as Current ratio

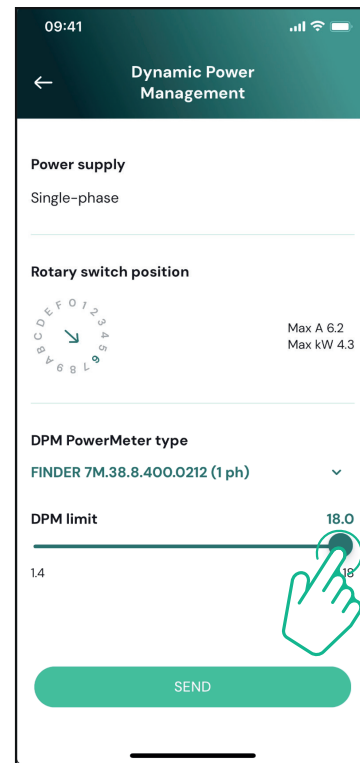

Click "Send" and confirm on the pop-up to restart **eLuxWallbox**.

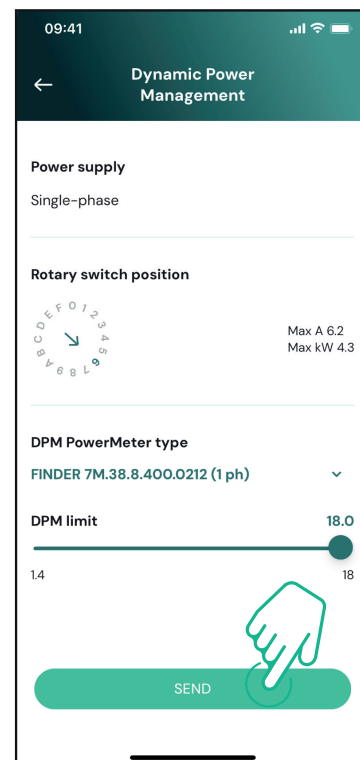

4.6. MIDcounter configuration

To complete installation of the **MIDcounter**, follow the steps below:

Select "**MIDcounter**" on the homepage

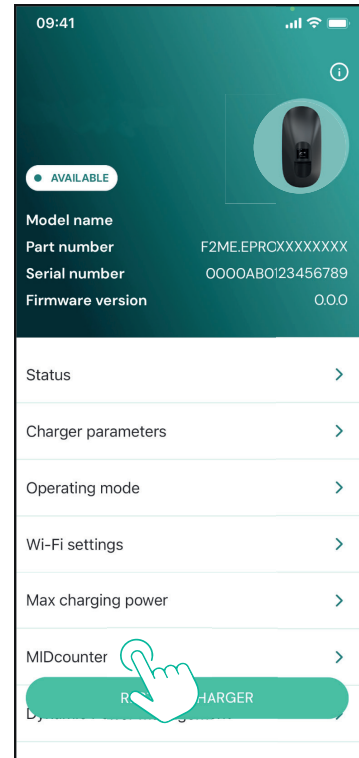

Select the **MIDcounter** type from the drop down menu, based on the model installed.

Select "OFF" from the drop down menu to disable the **MIDcounter** configuration.

Click "Send" to confirm.

To make the changes effective, click on the back arrow in the top left corner and restart **eLuxWallbox** through the dedicated button in the homepage.

If the installation has both the **PowerMeter (DPM)** and the **MIDcounter** it is possible to proceed with **DPM** configuration before restarting.

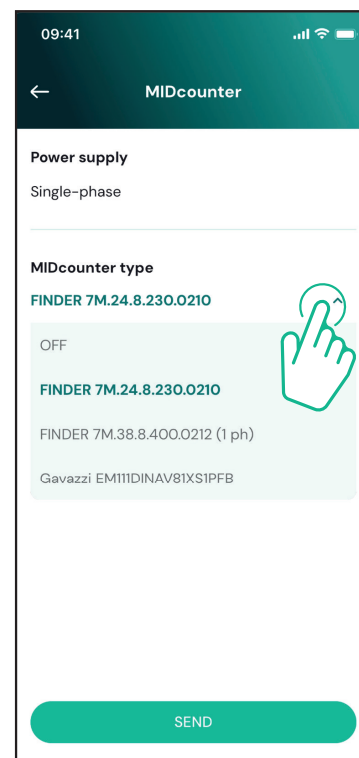

5. TROUBLESHOOTING

Error conditions are stored in the diagnostic logs and shown on the charger panel:

- On the **eLuxWallbox Move** model, the LED bar blinks red. See the **Diagnostic** section of PowerUP or the end-user App for the detailed error code.
- On the **eLuxWallbox** model, the display shows the error code, which is also available in the **Diagnostic** section of PowerUP.

When an error occurs, the charge is interrupted, and the socket is unlocked to allow you to disconnect the plug.

The following table provides a list of errors that can occur and the relative troubleshooting. If the error persists, note the serial number on the charger label and contact Customer Service.

Error code / issue	"Error Description"	Troubleshooting
100	Lack of power supply	<p>Check if the circuit breaker is ON. Check that the CN1 cabling is correct. Check the voltage in CN1.</p>
101	Overheating	<p>Disconnect the Type 2 cable, wait for the temperature to drop, then the error will clear.</p> <p>To restart the charging session, plug in the cable again. Make sure that installation site is compatible with temperature range (25°C/+50°C without direct exposure to sunlight)</p>
102	Communication error between MCU and MPU.	<p>Restart the charger from the circuit breaker, leaving the charger switched off for at least 60 seconds.</p>
103	Hardware fault, ground protection device error (GPD error)	<p>Check the cabling on CN1:</p> <ul style="list-style-type: none"> - in single-phase, make sure that ground cable is connected to PE, the Neutral cable is connected to N and the phase cable to T - in three-phase, make sure that the ground cable is connected to PE, the Neutral cable is connected to N and the phase cables L1, L2 and L3 are connected to T, S, and R. <p>Check whether the voltage difference between PE and N does not exceed 10V. Check PE connection</p> <p>If all connections are checked and the error persists, open the charger and modify the configuration of the Dipswitch (SW2) connector.</p>

104	Hardware fault, residual current monitor AC error. (RCM AC trip)	<p>Try to start a new charging session, removing and plugging in all the connectors.</p> <p>If the problem persists, check for the presence of any problems in the charging cable or vehicle inlet.</p> <p>If the cables and the EV don't show any problem, check CN27 connector and RCM cable.</p>
105	Hardware fault, residual current monitor DC error. (RCM DC trip)	<p>Check that the problem is not with the cable or vehicle. If possible, try another charging session with a different cable or vehicle.</p>
106	Internal meter error	<p>Restart the charger from the circuit breaker, leaving the charger switched off for at least 60 seconds.</p>
107	PowerMeter (DPM) communication error	<p>Check that the communication configuration on the DPM PowerMeter device is correct.</p> <p>Check that the DPM model configuration in the installer App is correct.</p> <p>Check the communication cable wiring on CN12.</p> <p>Check that the communication cable used is suitable for Modbus RS485 and cable length.</p>
108	Configuration Error, Rotary switch position (supply type) is not consistent with the DPM/ MID type.	<p>Check the position of the rotary switch. If it is not consistent with the 1-ph/3-ph installation, change it according to the table in the manual, then restart the charger.</p> <p>If the accessories (DPM/MID) are not installed, make sure that the function is disabled in the installer App.</p> <p>If the accessories (DPM/MID) are installed, check that the correct model is selected on the installer App. Then restart the charger.</p>
109	Main/secondary RS485 communication error	<p>Check the configuration of the Main/Secondary set up from installer App.</p> <p>Check that the Main charger is available.</p> <p>Check that the wiring of the communication cable on CN9 and CN10 is correct.</p> <p>Check that the communication cable used is suitable for Modbus RS485.</p>

110	MIDcounter communication error	<p>Check that the communication configuration on the MIDcounter device is correct.</p> <p>Check the communication cable wiring on CN12.</p> <p>Check that the communication cable used is suitable for Modbus RS485.</p> <p>Check that the MID model configuration in the installer App is correct.</p>
300	Inconsistency between the charger contactor command and feedback	<p>Restart the charger from the circuit breaker, leaving the charger switched off for at least 60 seconds.</p> <p>If error persists even after restart, call Customer Service.</p>
301	Short circuit detected on the Control Pilot line.	<p>With the charger switched off, check that there is no damage and no defects inside and outside the socket (if so, avoid using the charger and contact Customer Service).</p> <p>Check that the problem is not related to the cable or vehicle and try another charge session (with another vehicle or cable if possible).</p>
302	State E or F set on the Control Pilot line.	<p>With the charger switched off, check that there is no damage and no defects inside and outside the cable and its connectors (if so, avoid using it and attempt charge with another cable).</p>
303	Control Pilot disconnected.	<p>Check that the cable connectors are fully inserted inside the charger socket and vehicle inlet.</p>
304	Proximity Pilot disconnected.	<p>Check that the problem is not related to the cable or vehicle and try another charge session (with another vehicle or cable if possible).</p>
305	Broken Proximity Pilot detected.	<p>Check that the problem is not related to the cable or vehicle and try another charge session (with another vehicle or cable if possible).</p>
306	Diode fault detected on Control Pilot line (no - 12V).	<p>Attempt a new charging session unplugging and reinserting the cable from both the charger and vehicle inlet.</p>
307	Control Pilot disconnected.	<p>With the charger switched off, check that there is no damage and no defects inside and outside the cable and its connectors (if so, avoid using it and attempt charge with another cable).</p> <p>Check that the cable connectors are fully inserted inside the charger socket and vehicle inlet.</p> <p>Check that the problem is not related to the cable or vehicle and try another charge session (with another vehicle or cable if possible).</p>

308	Inconsistency between the motor command and feedback, or the motor is in an error condition.	<p>Attempt a new charging session unplugging and reinserting the cable from both the charger and vehicle inlet.</p> <p>Check that the cable connectors are fully inserted inside the charger socket and vehicle inlet.</p>
309	Motor check error during EVSE initialization phase.	Restart the charger from the circuit breaker, leaving the charger switched off for at least 60 seconds.
310	Error detected before charging (PP not detected, or motor fault, or CP not detected).	<p>With the charger switched off, check that there is no damage and no defects inside and outside the cable and its connectors (if so, avoid using it and attempt charge with another cable).</p> <p>Check that the cable connectors are fully inserted inside the charger socket and vehicle inlet.</p>
311	Error detected after charging (motor fault, or CP not disconnected).	Check that the problem is not related to the cable or vehicle and try another charge session (with another vehicle or cable if possible).
312	Emergency stop received from the MPU.	Restart the charger from the circuit breaker, leaving the charger switched off for at least 60 seconds.
313	Current detected during charging, with 100% duty cycle on the Control Pilot line.	Check that the problem is not cable nor vehicle related, attempt a new charging session with another cable and/or charger.
315	Current over limits on phase L1	Unplug the cable, if possible lower the power of charge on the vehicle side and attempt a new charging session.
316	Current over limits on phase L2	
317	Current over limits on phase L3	
318	Voltage below a threshold on phase L1	<p>Check the rotary switch position is consistent with 1-ph/3-ph installation.</p> <p>Check that the voltage on CN1-T is above 196 V.</p> <p>If the voltage is below 196 V, check the electric system or contact the energy supplier.</p> <p>If an error occurs during vehicle charging, try to reduce the set-up charging power and verify that the electric system is correctly dimensioned for the power drawn by the vehicle.</p>

319	Voltage below a threshold on phase L2	The rotary switch is in a three-phase position. Check that the intended installation is in three-phase. If not, select the correct rotary switch position as per Installation Manual.
320	Voltage below a threshold on phase L3	<p>Check that the voltage on CN1-S and R is above 196 V. If the voltage is below 196V, check the electric system or contact the energy supplier.</p> <p>If an error occurs during vehicle charging, try to reduce the set-up charging power and verify that the electric system is correctly dimensioned for the power drawn by the vehicle.</p>
321	Forbidden state change (IEC 61851-1)	<p>EV does not meet IEC 61851-1 standards for starting a charge session.</p> <p>Attempt a new charging session unplugging and reinserting the cable from both the charger and vehicle inlet.</p> <p>If the error persists, contact the vehicle manufacturer.</p>
	Display/LED stuck in Welcome mode (LED blinks red-green-blue)	Restart the charger from the circuit breaker, leaving the charger switched off for at least 60 seconds.
	LED or display does not light up at startup	
	The charger does not start	<p>Let the unit restart, it may take up to 30 seconds.</p> <p>Check if the circuit breaker is ON.</p> <p>Check that the CN1 cabling is correct.</p> <p>Check the voltage in CN1.</p> <p>Restart the charger from the circuit breaker, leaving the charger switched off for at least 60 seconds.</p>
	Cable stuck in the charger socket	Turn off the charger from the circuit breaker, then remove the cable.
	Suspended Charging with solid green LED/ message on the display. The charging session is suspended by the DPM or the EV. The session may resume.	<p>Verify that the max power in the DPM power limit section of the installer App is consistent with the contract power value in kW as indicated in the user's electricity contract. If the value is correct, wait for the charging session to resume or turn off some house loads.</p> <p>In the case of 3-ph installation, verify that the electrical loads are well balanced on the phases of the domestic system.</p>

	<p>App pairing does not complete after QR scan.</p>	<p>Check the integrity of the QR code on the label. Update the App to the latest version. Close and restart the App, then try again. Restart the charger from the circuit breaker, leaving the charger switched off for at least 60 seconds.</p>
--	---	---

6. CLEANING

Cleaning the outside of the device is always recommended when necessary and should be carried out using a soft damp cloth with a mild detergent. When finished, wipe off any traces of moisture or liquid with a soft dry cloth.



CAUTION: Avoid strong jets of air or water as well as the use of soaps or detergents that are too harsh and corrosive for the materials of the charger.

7. PACKAGING DISPOSAL



Dispose of packaging in an environmentally friendly manner. The materials used for packaging this product can be recycled and must be disposed of in compliance with the legislation in force in the country of use. The following disposal directions will be found on the packaging based on the type of material.



NOTE: Further information about current disposal facilities can be obtained from local authorities.

8. ASSISTANCE

If you have any questions about the installation of **eLuxWallbox**. For any other information or requests for support, please contact Free2move eSolutions S.p.A. through the relevant section of its website: www.esolutions.free2move.com.

9. DISCLAIMER

Free2move eSolutions S.p.A. will not be held responsible for any damage directly or indirectly caused to people, things or animals due to the failure to comply with all the provisions set out in this Manual, and the warnings regarding the installation and maintenance of **eLuxWallbox**.

Free2move eSolutions S.p.A. reserves all rights to this document, the article and the illustrations it contains. The reproduction, whole or in part, disclosure to third parties or use of its contents is prohibited without the prior written consent of Free2move eSolutions S.p.A.

Any information in this manual may be changed without prior notice and does not represent any obligation on the part of the manufacturer. Images in this manual are for illustrative purposes only and might differ from the delivered product.

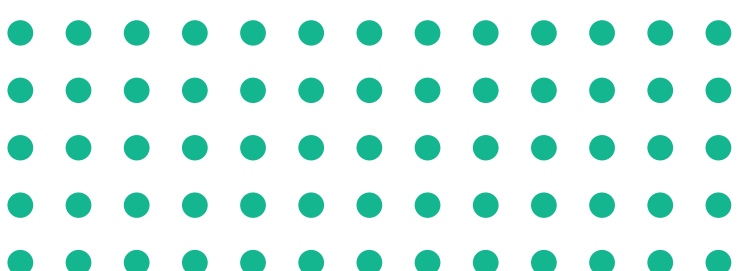

Registered office

Free2move eSolutions S.p.A.

Piazzale Lodi, 3

20137 Milan - Italy

www.esolutions.free2move.com

EN

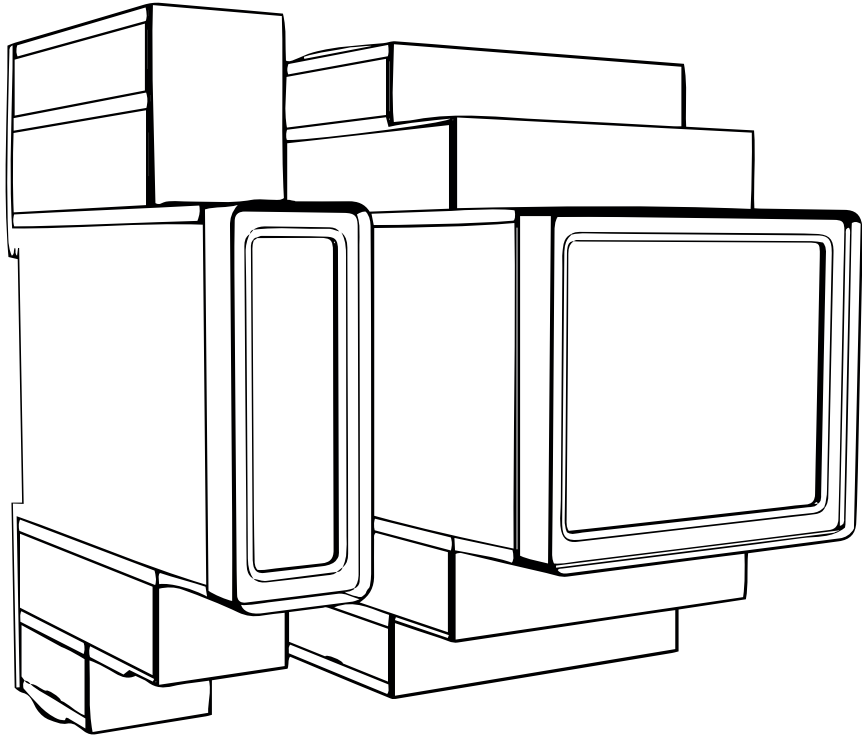
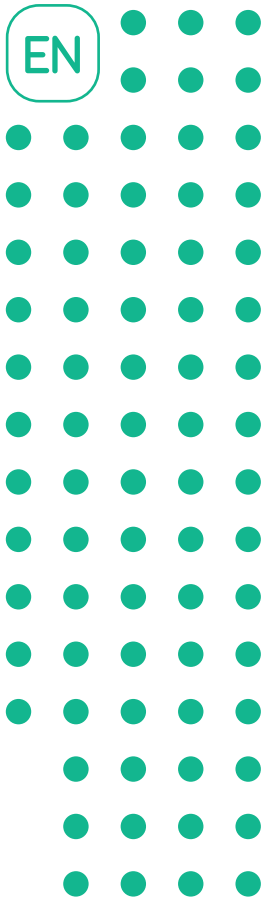

LuxWallbox

Accessories Manual



For safe and proper use,
follow these instructions.
Keep them for future reference

Table of content

1. INTRODUCTION	4
1.1. Purpose of the Manual	4
1.2. Identification of the Manufacturer.....	4
1.3. Structure of the Accessories Manual	4
1.4. Safety	5
1.5. Personal Protective Equipment (PPE).....	6
1.6. Warranty and delivery conditions	6
1.7. List of documents.....	7
1.8. Warnings	7
2. GENERAL INFORMATION	8
2.1. Fields of use	9
3. ACCESSORIES INSTALLATION	10
3.1. Installing PowerMeter (DPM).....	10
3.2. Installing MIDcounter	15
3.3. Communication cable installation	17
3.4. MIDcounter and PowerMeter (DPM) combined installation .	19
4. PowerMeter (DPM) and MIDcounter configuration.	22
4.1. Finder models.....	22
4.2. Gavazzi models.....	24
4.3. Device configuration summary	25
4.4. PowerMeter (DPM) and MIDcounter configuration on APP ..	26
4.5. PowerMeter (DPM) configuration	28
4.6. MIDcounter configuration.....	30
5. TROUBLESHOOTING.....	31
6. CLEANING.....	36
7. PACKAGING DISPOSAL	36
8. ASSISTANCE.....	37
9. DISCLAIMER.....	37



1. INTRODUCTION

1.1. Purpose of the Manual

This installation manual is a guide to help operators to work safely and carry out the installation operations needed to keep the charger in good working order.

The purpose of this document is to support qualified technicians who have received appropriate training, and demonstrated suitable skills and knowledge in the construction, installation, operation and maintenance of electrical equipment.

If the charger is used in a manner not specified in this manual, the protection provided by the charger may be impaired. This document contains the information required for the installation of the charger.

This document has been carefully checked by the Manufacturer Free2move eSolutions S.p.A. but oversights cannot be completely ruled out. If any errors are noted, please inform Free2move eSolutions S.p.A. Except for explicit contractual obligations, under no circumstances may Free2move eSolutions S.p.A. be held liable for any loss or damage resulting from the use of this manual, or from installation of the equipment. This document was originally written in English. In the event of any inconsistencies or doubts, please ask Free2move eSolutions S.p.A. for the original document.

1.2. Identification of the Manufacturer

The manufacturer of the charger is:

Free2move eSolutions S.p.A.

Piazzale Lodi, 3

20137 Milan – Italy

www.esolutions.free2move.com

1.3. Structure of the Accessories Manual





This manual is divided into chapters based on different topics and containing all the information that is needed to install the charger safely.

Each chapter is sub-divided into paragraphs which examine the fundamental points, and each paragraph may have its own title, along with sub-titles and a description.

1.4. Safety

This manual contains important safety instructions that must be followed during installation of the charger.

In order to fulfil this objective, this manual contains a number of precautionary texts, containing special instructions. These instructions are highlighted by a specific text box and are accompanied by a symbol, and are provided in order to ensure the safety of the personnel required to perform the operations described, and to avoid any damage to the charger and/or property:

	<p>This symbol means: DANGER</p> <p>This symbol is intended to highlight a dangerous situation for yourself and others. Read it carefully. Failure to comply with the instruction will result in an imminent hazardous situation which, if not avoided, will result in instant death, or serious or permanent injury.</p>
	<p>This symbol means: WARNING</p> <p>This symbol is intended to highlight safety information. Failure to comply with the instruction will result in a potentially hazardous situation which, if not avoided, could result in death or serious injury.</p>
	<p>This symbol means: CAUTION</p> <p>This symbol is intended to highlight safety information. Read it carefully. Failure to follow these instructions can result in death, serious injury or damage to equipment.</p>
	<p>This symbol means: NOTE</p> <p>Provides additional information to supplement instructions provided.</p>
	<p>This symbol means: NOTICE</p> <p>Provides instructions concerning the use of conduct necessary to handle the operations not associated with possible physical injuries.</p>

Installation must be carried out by qualified personnel. A dedicated, state-of-the-art electricity supply system must be designed and installed, and the system must be certified in compliance with local regulations and the energy supply contract.

Operators are required to read and fully understand this manual, and to comply strictly with the instructions it contains.

Free2move eSolutions S.p.A. cannot be held liable for damage caused to persons and/ or property, or to the equipment, if the conditions described in this document have not been complied with.





WARNING: Installation must be carried out in accordance with the regulations in force in the country of installation, and in compliance with all safety regulations for carrying out electrical work.

1.5. Personal Protective Equipment (PPE)

Personal Protective Equipment (PPE) means any equipment intended to be worn by the workers in order to protect them against one or more hazards likely to threaten their health or safety at the workplace, as well as any device or accessory intended for this purpose.

Since all the PPE indicated in this manual is intended to protect the personnel against health and safety hazards, the Manufacturer of the charger which is the subject of this manual recommends strict compliance with the indications contained in the various sections of this manual.

The list of PPE to be used in order to protect the operators against the residual risks present during the installation and maintenance interventions described in this document is provided below.

Symbol	Meaning
	Wear protective gloves
	Wear anti-static footwear



WARNING: It is responsibility of the operator to read and understand local regulations and evaluate the environmental conditions of the installation site in order to comply the need to wear additional PPE.

1.6. Warranty and delivery conditions

The warranty details are described in the Terms and Conditions of Sale included with the purchase order for this product and/or in the packaging of the product.

Free2move eSolutions S.p.A. assumes no responsibility for failure to comply with the instructions for proper installation, and cannot be held responsible for systems upstream or downstream of the equipment supplied.

Free2move eSolutions S.p.A. cannot be held responsible for defects or malfunctions deriving from: improper use of the charger; deterioration due to transport or particular environmental conditions or installation by unqualified persons.

Free2move eSolutions S.p.A. is not responsible for any disposal of the equipment, or parts thereof, that does not comply with the regulations and laws in force in the country of installation.



NOTICE: Any modification, manipulation or alteration of the hardware or software not expressly agreed with the manufacturer will immediately void the warranty.

1.7. List of documents

In addition to this manual, product documentation can be viewed and downloaded by visiting: www.esolutions.free2move.com.

1.8. Warnings



DANGER: Risk of electric shock and fire. Installation must be carried out in accordance with the regulations in force in the country of installation, and in compliance with all safety regulations for carrying out electrical work.

- Before installing or using the device, make sure that none of the components have been damaged. Damaged components can lead to electrocution, short circuits, and fire due to overheating. A device with damage or defects must not be used.
- Install **eLuxWallbox** away from petrol cans or combustible substances in general.
- Before installing **eLuxWallbox compatible accessories**, ensure the main power source has been disconnected.
- The **eLuxWallbox compatible accessories** must only be used for the specific applications they are designed for.
- Installation not carried out correctly may pose risks to the user.
- The charger must be connected to a mains network in compliance with local and international standards, and all the technical requirements indicated in this manual.
- Children or other persons not able to gauge risks related to the installation of the charger could suffer serious injury or put their lives at risk.
- Pets or other animals must be kept away from the device and packaging material
- Children must not play with the device, accessories or packaging provided with the product.
- The only part that can be removed from **eLuxWallbox**, is the removable cover. Access under the cover is only permitted by qualified personnel during installation, dismantling or maintenance.
- **eLuxWallbox** can only be used with an energy source.
- Necessary precautions to ensure safe operation with Active Implantable Medical Devices must be taken. To determine whether the charging process could adversely affect the medical device, please contact its manufacturer.

2. GENERAL INFORMATION

eLuxWallbox is an Alternate Current charging solution for powering electric vehicles and hybrid plug-ins, and is ideal for semi-public and residential use. The charger is available in three-phase or single-phase configurations and is equipped with a Type 2 socket.

The charger charges electric vehicles up to 22 kW in three-phase, or up to 7.4 kW in single-phase. The charger includes connectivity options such as remote monitoring via the eSolutions control platform (CPMS). Its final configuration must be completed using the **PowerUp** application. For the end user, the **eLuxWallbox** can be managed via the dedicated user's eSolutions Charging App. Both applications are available on Google Play™ and Apple Store®.

This charger is equipped with a SIM card for connection to the 4G mobile network.

The SIM card is automatically activated the first time the charger is turned on.

This document describes how to install the external accessories compatible with the **eLuxWallbox**.

The external accessories described in this manual are:

- **PowerMeter (DPM)**: an energy meter that enables the Dynamic Power Management (**DPM**) which is a smart function that allows an electric vehicle to be recharged using only the power available at home, modulating the charging power and avoiding unpleasant blackouts.
- **MIDcounter**: a certified energy meter that allows to monitor the consumption of the **eLuxWallbox** during each charging session.

This manual contains a description of the characteristics of the different accessories, information on models, installation process and final configuration of the devices.

The **eLuxWallbox** is configured to be used with the following electrical accessories: **PowerMeter (DPM)** or **MIDcounter**:

- Gavazzi, 1-phase, Direct, 32 A
- Finder, 1-phase, Direct, 40 A
- Gavazzi, 3-phase, Direct, 65 A
- Finder, 3-phase, Direct, 80 A

PowerMeter (DPM):

- Gavazzi, 1-phase, Indirect with 1x CT 100 A
- Gavazzi, 1-phase, Indirect with 1x CTV 60 A
- Gavazzi, 3-phase, Indirect with 3x CT 150 A



WARNING: Do not try to install the Electrical Accessories if you are not qualified as a professional electrician. To do so could cause serious danger and harm to you and to the people, property or animals around you.

To complete the installation, it is necessary to configure the **eLuxWallbox** through the dedicated apps:

	Installer's app: PowerUp
Product versions (EU):	EPRO23S224GWBAX
Product versions (UK):	EPRO23S224GWBAS



WARNING: Only Electrical Accessories suggested by Free2move eSolutions S.p.A. are compatible. Installation must be performed by qualified personnel in accordance with local regulations.

2.1. Fields of use

Free2move eSolutions S.p.A. declines all liability for any damage whatsoever due to incorrect or careless actions.

The charger may not be used for any purpose other than the one it is intended to fulfill.

The equipment must not be used by children or people with limited mental or physical abilities, or even by adults or expert professionals if the charger undergoes operations that do not comply with this manual and accompanying documentation.

The charger is a charging device for electric vehicles; the following classification (according to IEC 61851-1) identifies its characteristics:

- Power supply: permanently connected to the AC power supply grid
- Output: Alternate Current
- Environmental conditions: indoor / outdoor use
- Fixed installation
- Protection against electric shock: Class I
- EMC Environment classification: Class B
- Charging type: Mode 3 according to the IEC 61851-1 standard
- Optional function for ventilation not supported

3. ACCESSORIES INSTALLATION

To install the electrical accessories, it is necessary to use Modbus communication cables with the following characteristics:

- Modbus RS485 twisted STP 2x2 AWG24 or S/FTP cat.7 suitable for installation with a 400V power line
- Conductor size: 0.5 mm²
- Stripping length: 10 mm
- Recommended maximum length: 150 m

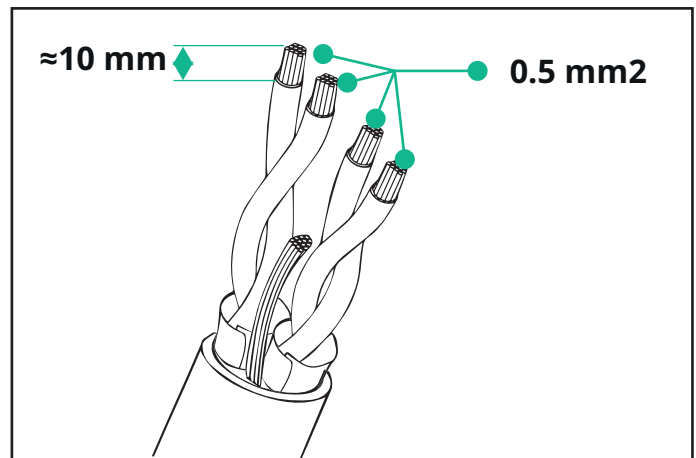

3.1. Installing PowerMeter (DPM)

PowerMeter (DPM) is an energy meter that enables the Dynamic Power Management (**DPM**) which is a smart function that allows an electric vehicle to be recharged using only the power available at home, modulating the charging power and avoiding unpleasant blackouts. Whenever other appliances are being used during the charging session, the system can modulate the charging power towards the car, even temporarily suspending the charging session. As soon as the other domestic appliances are switched off, the session will resume.

The **DPM** smart logic works both in three-phase and in single-phase installations.



WARNING: When installing in three-phase systems, make sure that the electrical loads (including the wallbox) are well balanced between the phases of the electrical system.



WARNING: Before carrying out any installation or maintenance work on the device, it must be ensured that the power supply is switched off.

For Direct models of the PowerMeter (DPM):

Place the **PowerMeter (DPM)** after the main utility meter. The **PowerMeter (DPM)** must measure all the electrical loads, including the **eLuxWallbox**.

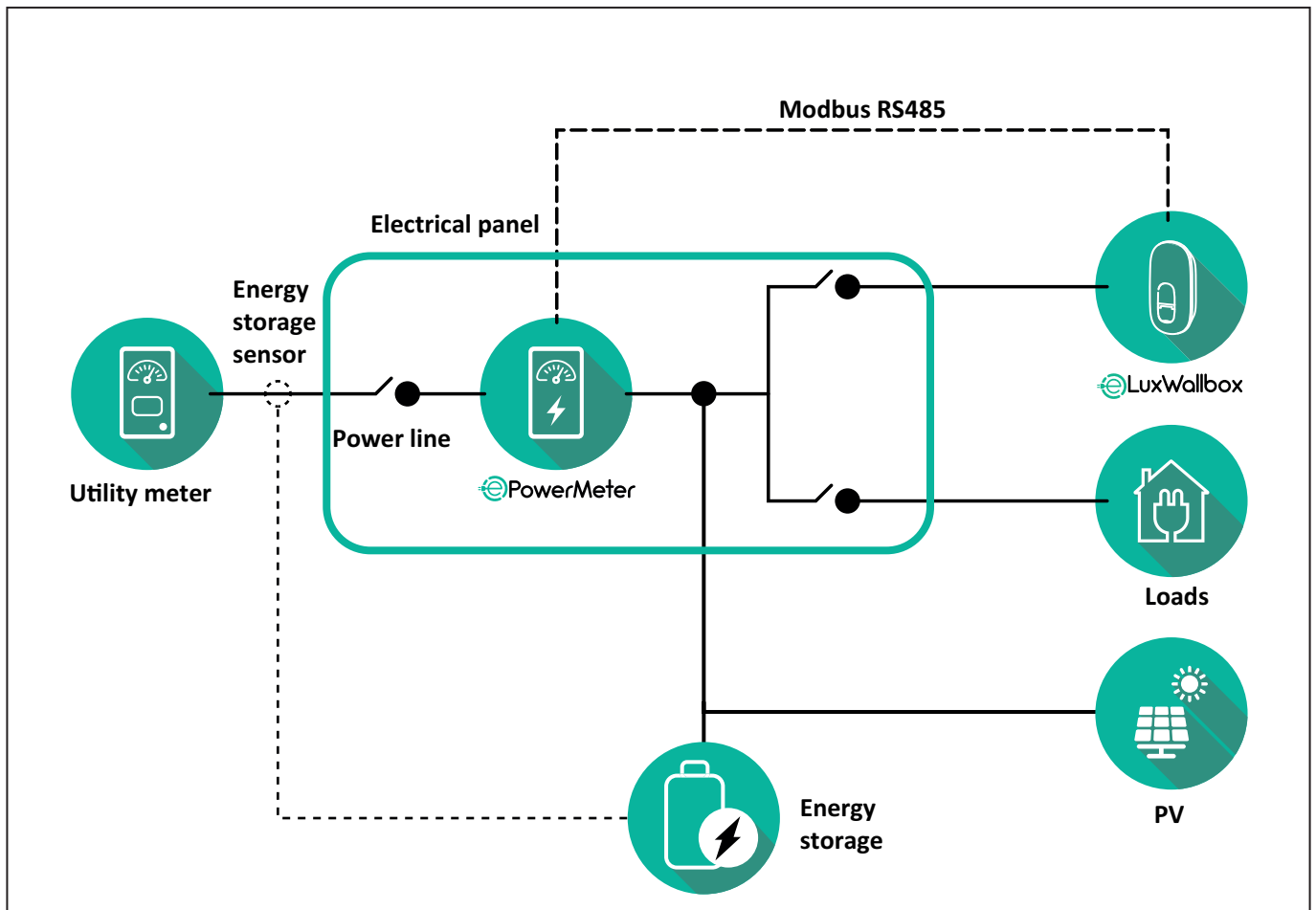

For Direct models of the PowerMeter:



WARNING: During the installation always refer to the manufacturer installation manual provided with the meter.



NOTE: For the single-phase or three-phase electrical connection of the Direct **PowerMeter**, please refer to the diagrams below.

Finder model 1ph and 3ph

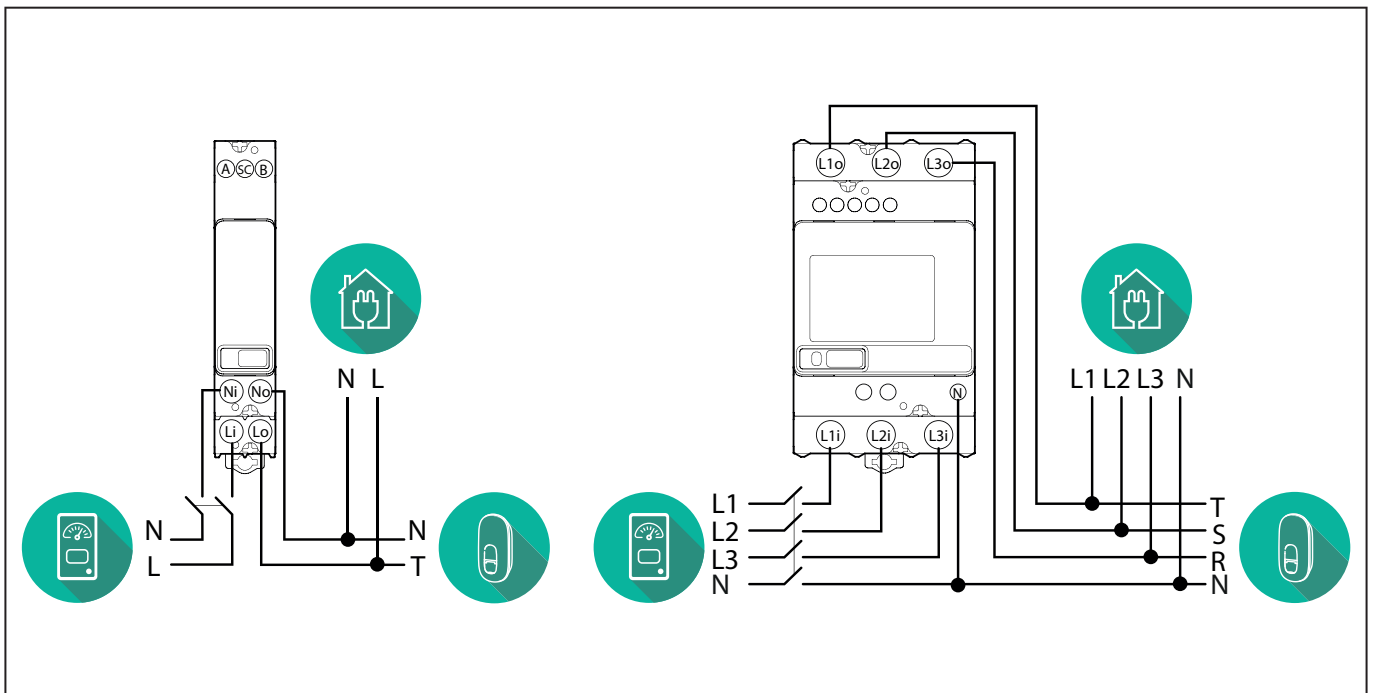

Gavazzi model 1ph and 3ph

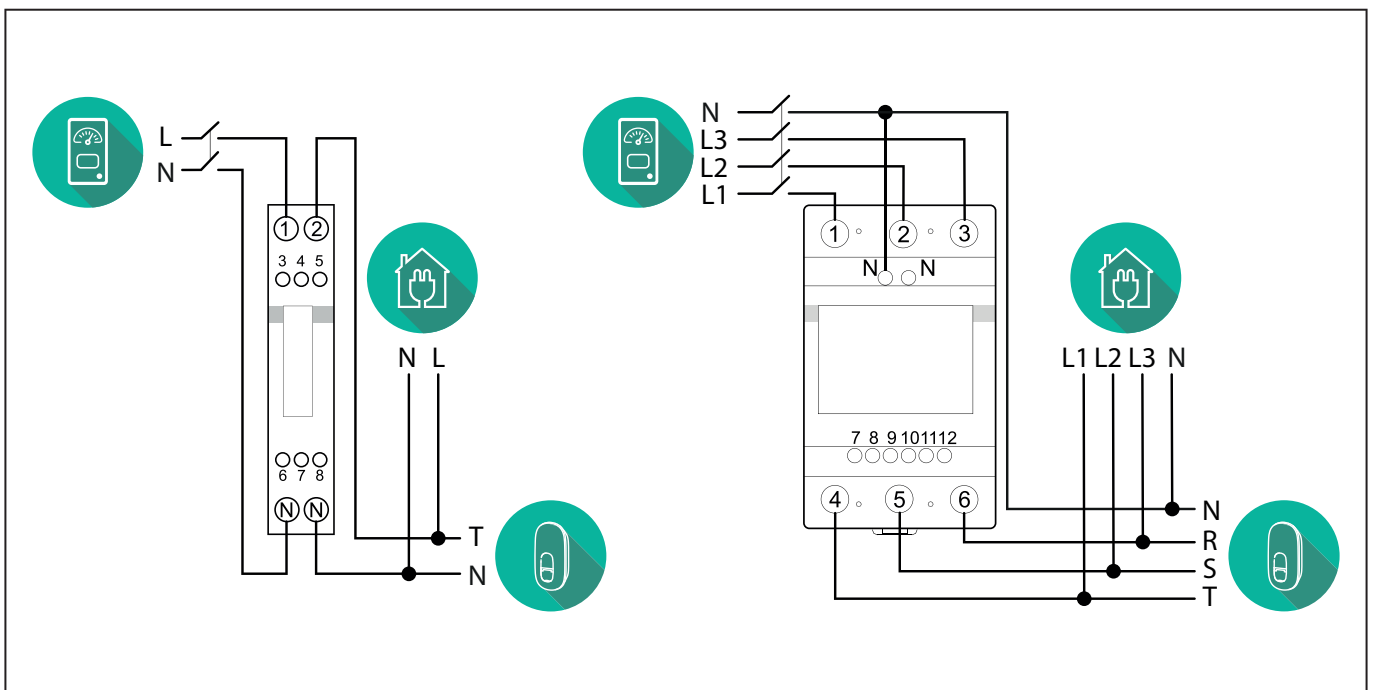

NOTICE:



1) If PV is present, the **PowerMeter** should be placed between the Utility Meter and the PV connection point.

2) If there is a home Energy storage, the **PowerMeter** should be placed between the Energy storage connection point and the Energy storage measurement sensor.

For Indirect models of the PowerMeter:

Place the CT (current transformer) of the **PowerMeter** after the main utility meter and before the main switch of the house/building. The current transformer must measure all the domestic loads, including the **eLuxWallbox**.

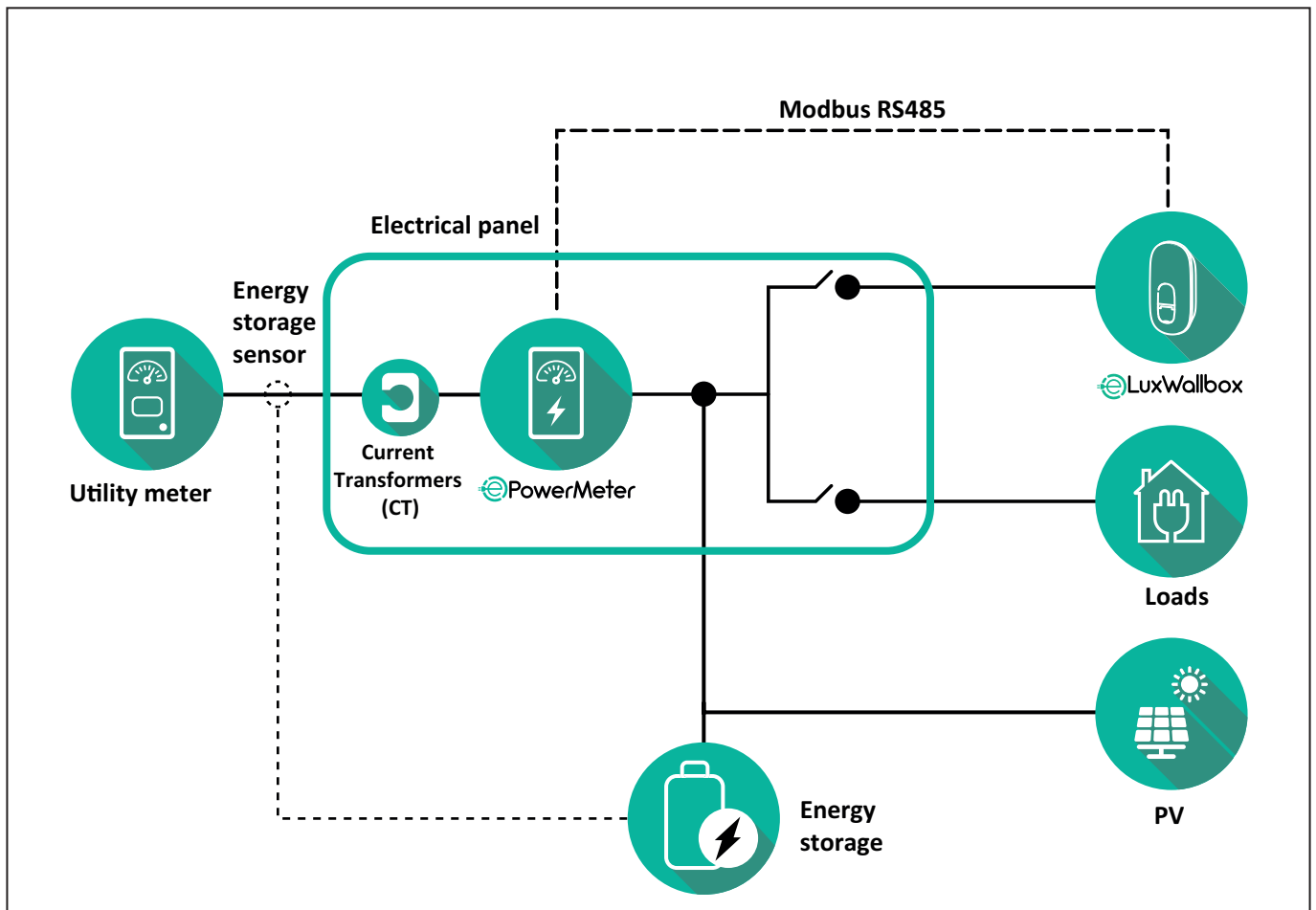

NOTICE:



1) If PV is present, the **PowerMeter** Current Transformers (CT) should be placed between the PV connection point and the Utility Meter.

2) If there is a home Energy storage, the **PowerMeter** Current Transformers (CT) should be placed between the Energy storage connection point and the Energy storage measurement sensor.

Connect the Current Transformers (CT) as indicated in the meter installation manual. Point the arrow on the CT in the direction of the loads.

For the three-phase or single-phase electrical connection of the indirect **PowerMeter**, refer to the diagrams below.

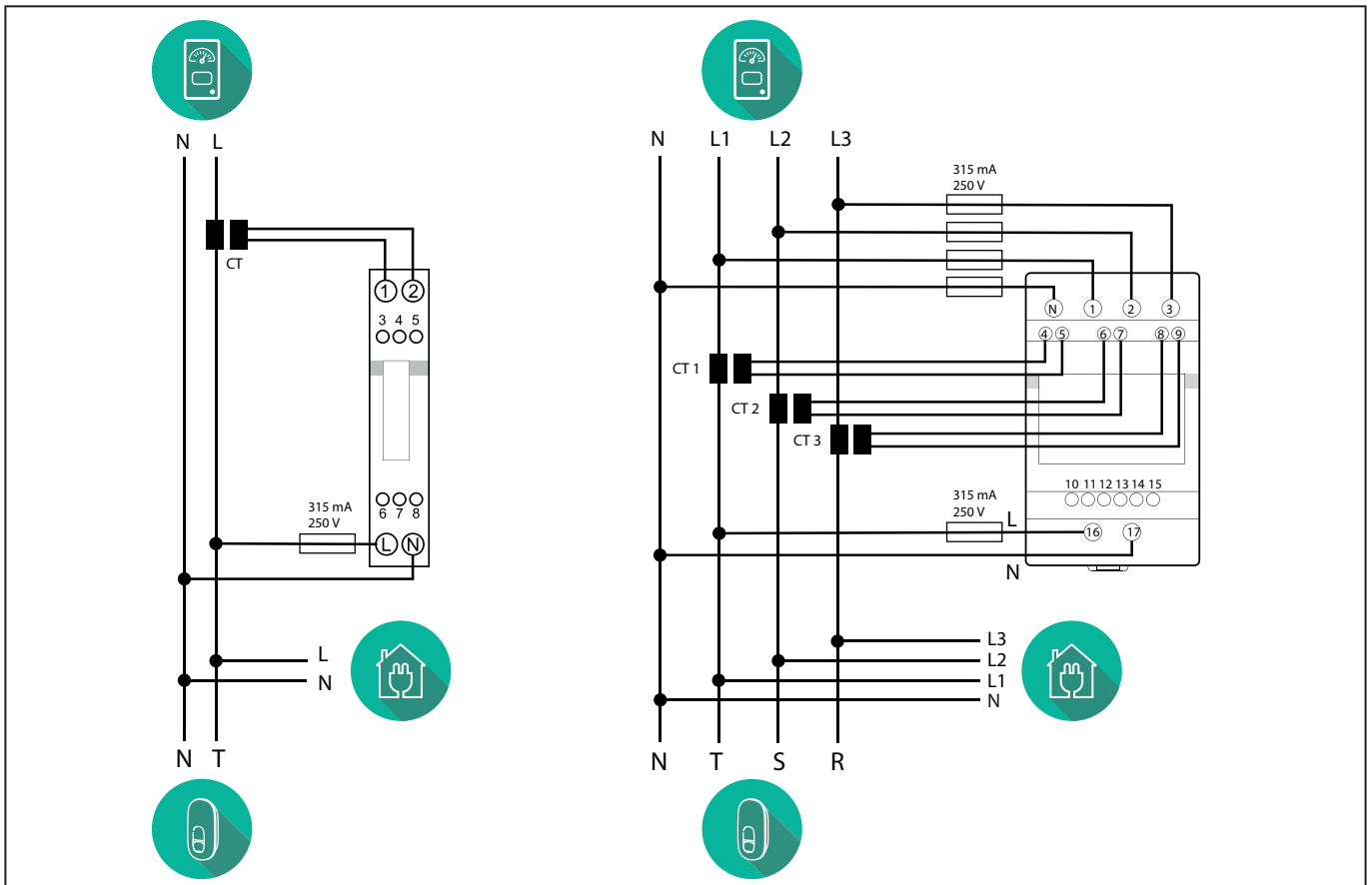

3.2. Installing MIDcounter

The **MIDcounter** is a certified energy meter that allows the consumption of the charger to be safely and reliably monitored during each charging session.

All the relevant data of the charging sessions is automatically recorded by a certified **MID** meter and transferred from the charger to the Charge Point Management System (CPMS).



WARNING: The power to the charger must remain off during this step.

Place the **MIDcounter** on the same power line as the charger, after the electrical protection devices.

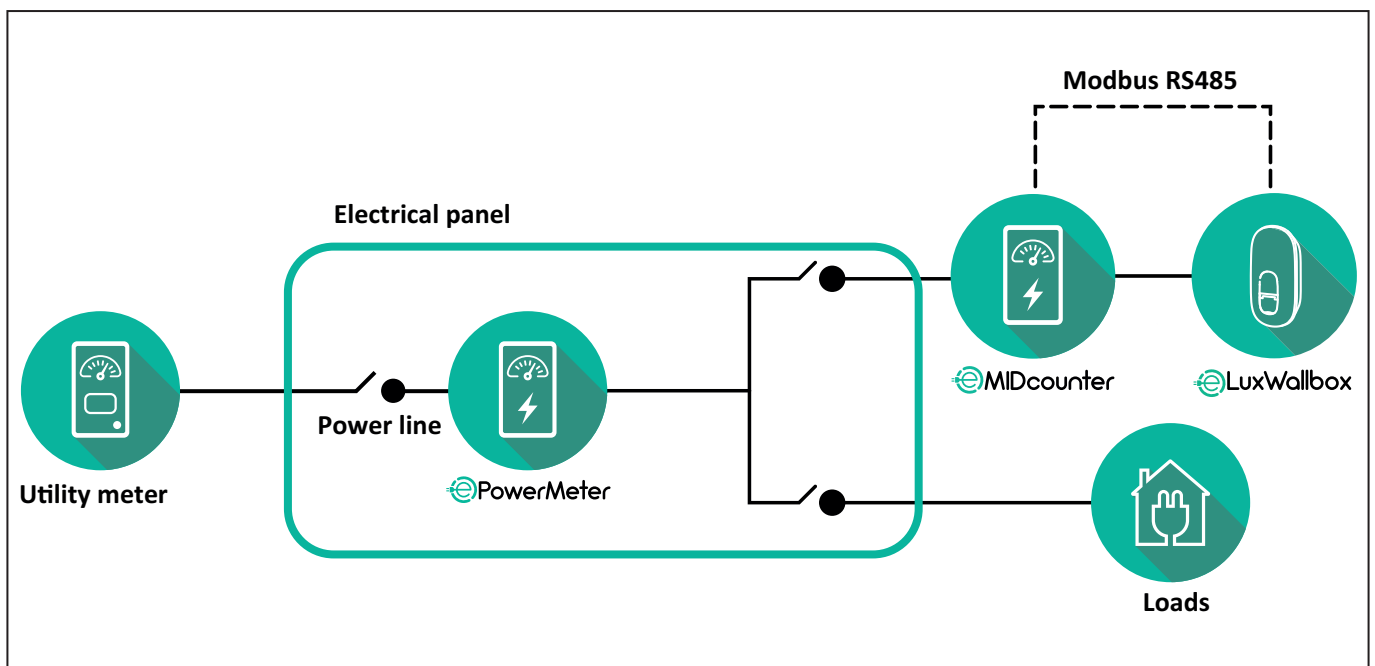

See the diagrams below for single phase and three phase electrical connection of **MIDcounter** (Finder and Gavazzi).

**Finder 1-phase, Direct, 40 A
(7M2482300210)**

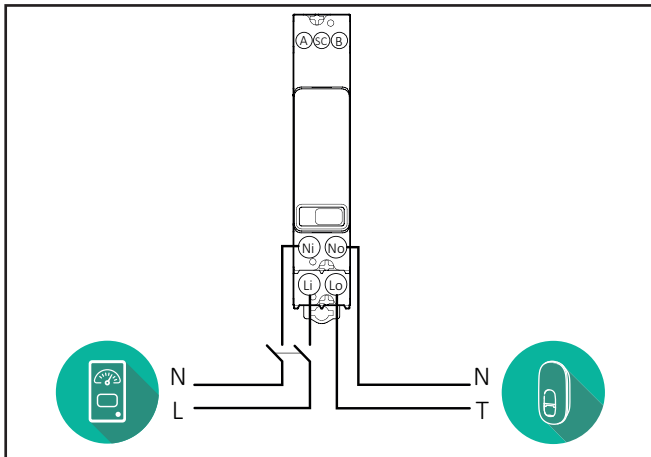

**Gavazzi, 3-phase, Direct, 65 A
(EM340DINAV23XS1PFB)**

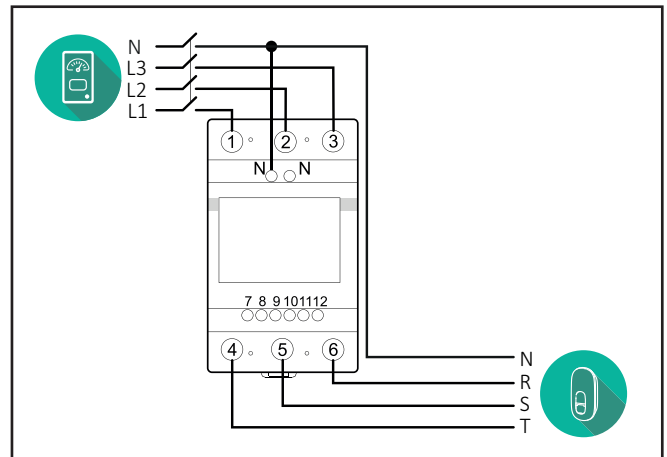

**Finder 3-phase, Direct, 80 A
(7M3884000212)**

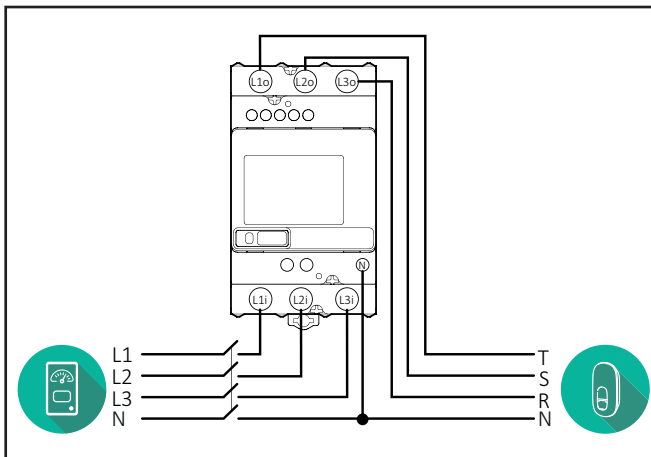

**Gavazzi, 1 phase, Direct, 100 A
(EM112DINAV01XS1PFB)**

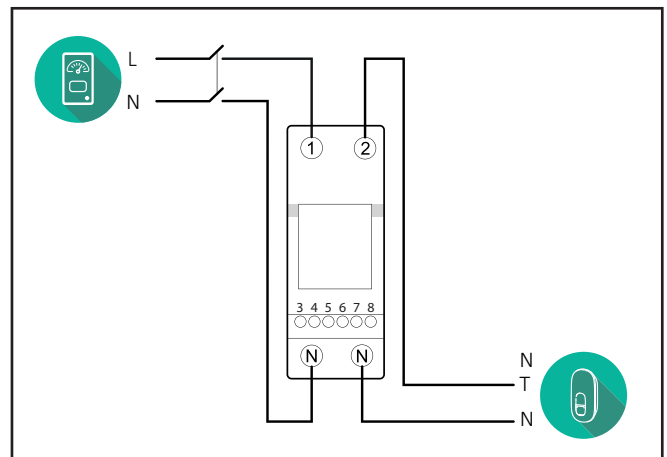

**Gavazzi, 1-phase, Direct, 32 A
(EM111DINAV81XS1PFB)**

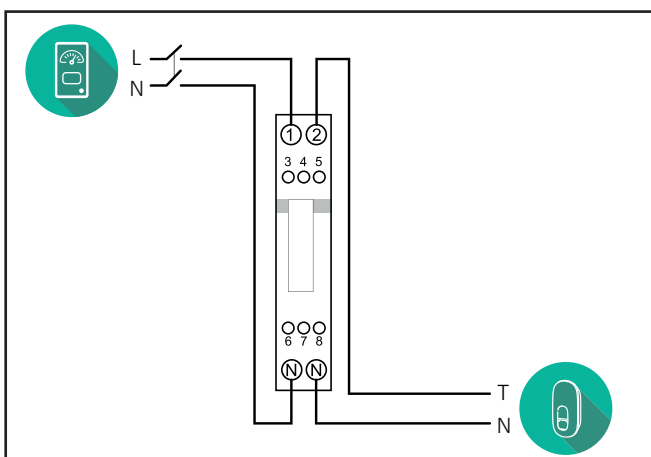

3.3. Communication cable installation

Install a communication cable between the **PowerMeter (DPM)** and the **eLuxWallbox**.

- On the **eLuxWallbox**, remove the protective cap of the communication cables entry point and insert the \varnothing 25 mm corrugated sheath.
- Tighten the box-cable sheath junction.
- Insert the communication cable, pulling it to a suitable length so that it reaches the communication port CN12, leaving some slack.
- Connect the Modbus RS485 communication cable to the GND, - and + pins of the CN12 connector.



NOTE: It is possible to replace the box-cable sheath junctions with \varnothing 25mm cable gland (not provided by the manufacturer).

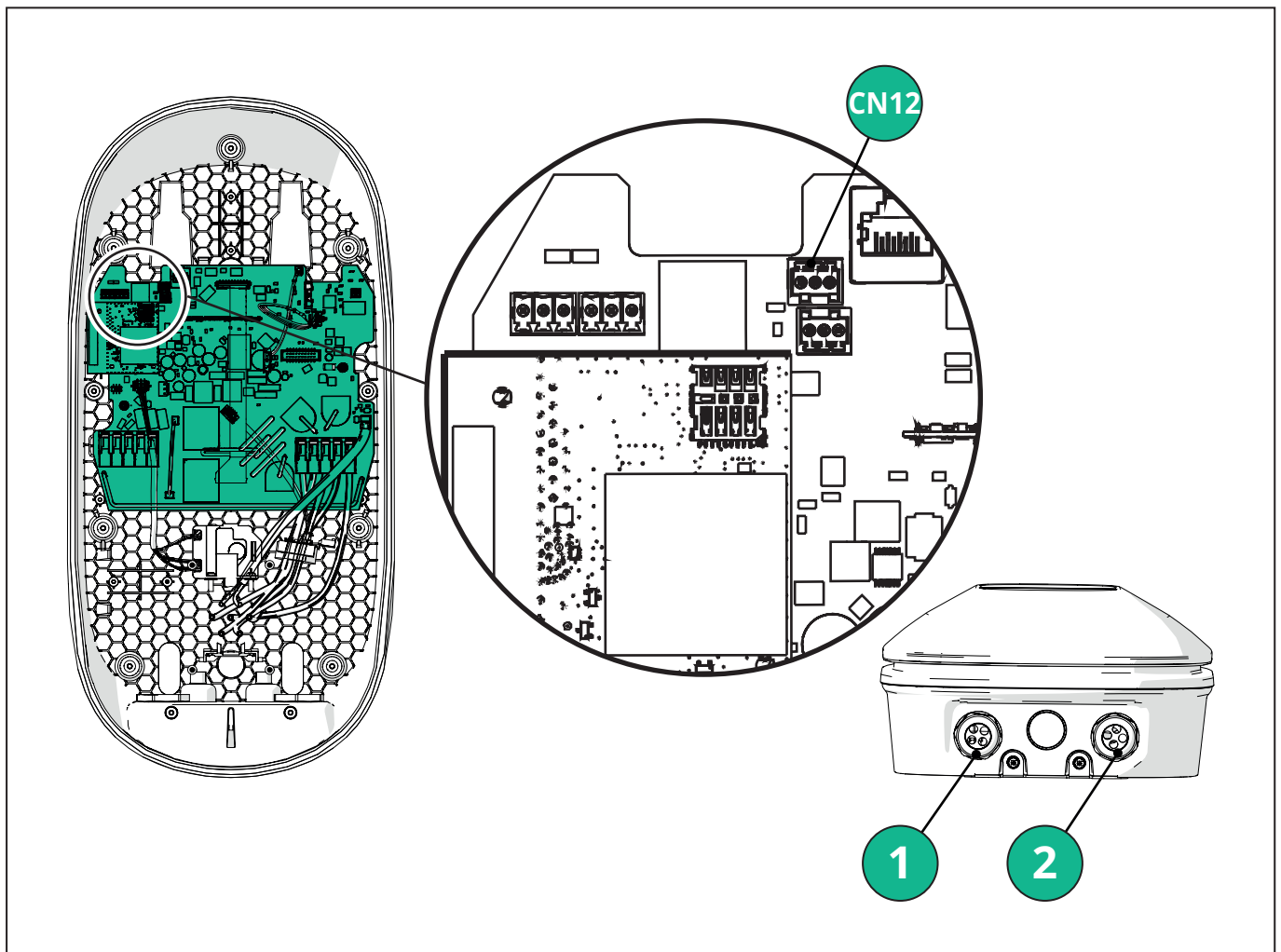

1 - Power supply cables

2 - Communication cables

CN12 - RS485 Modbus for external meter communication (**DPM** and **MID**)

Connect the communication cables in the following order from the **PowerMeter (DPM)** to **eLuxWallbox**.



WARNING: If the installation includes both accessories, follow the instructions for "MIDcounter and PowerMeter (DPM) combined installation".

CN12	Finder 1ph 7M.24.8.230.0210
GND	SC
-	B
+	A

CN12	Gavazzi 3ph EM340DINAV23XS1PFB
GND	10
-	9
+	8

Junction 9/7

CN12	Finder 3ph 7M.38.8.400.0212
GND	SC
-	B
+	A

CN12	Gavazzi Ind 1ph EM111DINAV51XS1X / EM111DINMV51XS1X
GND	7
-	8
+	6

Junction 8/5

CN12	Gavazzi 1ph EM111DINAV81XS1PFB
GND	7
-	8
+	6

Junction 8/5

CN12	Gavazzi Ind 3ph EM330DINAV53HS1X
GND	13
-	12
+	11

Junction 12/10

3.4. MIDcounter and PowerMeter (DPM) combined installation

If installing both electrical accessories, the positioning of **MIDcounter** together with the **PowerMeter (DPM)** is indicated in the diagram below:

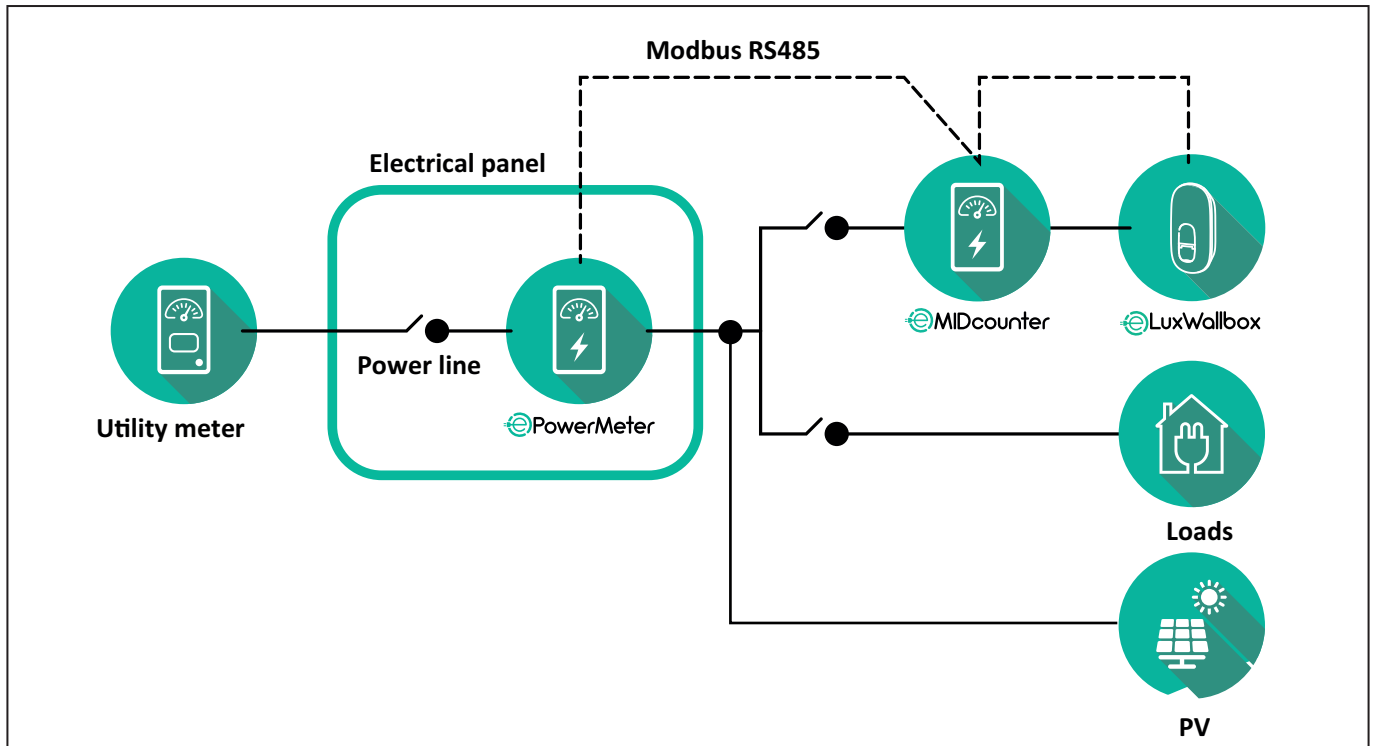

Connect the Modbus communication cables. The **PowerMeter (DPM)**, **MIDcounter** and the **eLuxWallbox** must be connected on the same communication bus in a Daisy chain format.

On the **eLuxWallbox**:

- Remove the protective cap of the communication cable entry point and insert the \varnothing 25 mm corrugated sheath.
- Tighten the box-cable sheath junction.
- Insert the communication cable, pulling it to a suitable length so that it reaches the communication port CN12, leaving some slack.
- Connect the Modbus RS485 communication cable to the GND, - and + pins of the CN12 connector.

Use the table below to connect the communication cables from the accessories to the **eLuxWallbox**.

Single-Phase.

PowerMeter (DPM)	MIDcounter	eLuxWallbox
EM111DINAV51XS1X - EM111DINMV51XS1X	EM111DINAV81XS1PFB	CN12
GND (7)	GND (7)	GND
A- (8) / T*(5)	A- (8)	-
B+ (6)	B+ (6)	+
EM111DINAV51XS1X - EM111DINMV51XS1X	7M 24.8.230.0210	CN12
GND (7)	SC	GND
A-(8) / T*(5)	B-	-
B+ (6)	A+	+
EM111DINAV81XS1PFB	EM111DINAV81XS1PFB	CN12
GND (7)	GND (7)	GND
A-(8) / T*(5)	A- (8)	-
B+ (6)	B+ (6)	+
EM111DINAV81XS1PFB	7M 24.8.230.0210	CN12
GND (7)	SC	GND
A-(8) / T*(5)	B-	-
B+ (6)	A+	+
7M 24.8.230.0210	EM111DINAV81XS1PFB	CN12
SC	GND (7)	GND
B-	A- (8)	-
A+	B+ (6)	+
7M 24.8.230.0210	7M 24.8.230.0210	CN12
SC	SC	GND
B-	B-	-
A+	A+	+

Three-Phase.

PowerMeter (DPM)	MIDcounter	eLuxWallbox
EM330DINAV53HS1X	EM340DINAV23XS1PFB	CN12
GND (13)	GND (10)	GND
A-(12) / T*(10)	A-(9)	-
B+ (11)	B+ (8)	+
EM330DINAV53HS1X	7M.38.8.400.0212	CN12
GND (13)	SC	GND
A-(12) / T*(10)	B-	-
B+ (11)	A+	+
EM340DINAV23XS1PFB	EM340DINAV23XS1PFB	CN12
GND (10)	GND (10)	GND
A-(9) / T*(7)	A-(9)	-
B+ (8)	B+ (8)	+
EM340DINAV23XS1PFB	7M.38.8.400.0212	CN12
GND (10)	SC	GND
A-(9) / T*(7)	B-	-
B+ (8)	A+	+
7M.38.8.400.0212	EM340DINAV23XS1PFB	CN12
SC	GND (10)	GND
B-	A-(9)	-
A+	B+ (8)	+
7M.38.8.400.0212	7M.38.8.400.0212	CN12
SC	SC	GND
B-	B-	-
A+	A+	+

*A 120 Ω terminating resistor must be installed on the devices at the ends of the Modbus chain. The resistor is present by default in the **eLuxWallbox**. Gavazzi models have a built-in resistor, which can be enabled by making a jumper between these terminals.

4. PowerMeter (DPM) and MIDcounter configuration

Power on the **PowerMeter (DPM)** and/or the **MIDcounter** when the electrical installation and communication installation are complete. Then proceed with the configuration on the display of the meters.

The configuration varies depending on the model.

4.1. Finder models

The following actions help to understand how to set Finder energy meters:

- Press the touchscreen button (a,b) to move between menus and parameters;
- Long press (~ 2 seconds) the touchscreen button (a,b) to enter and confirm selections

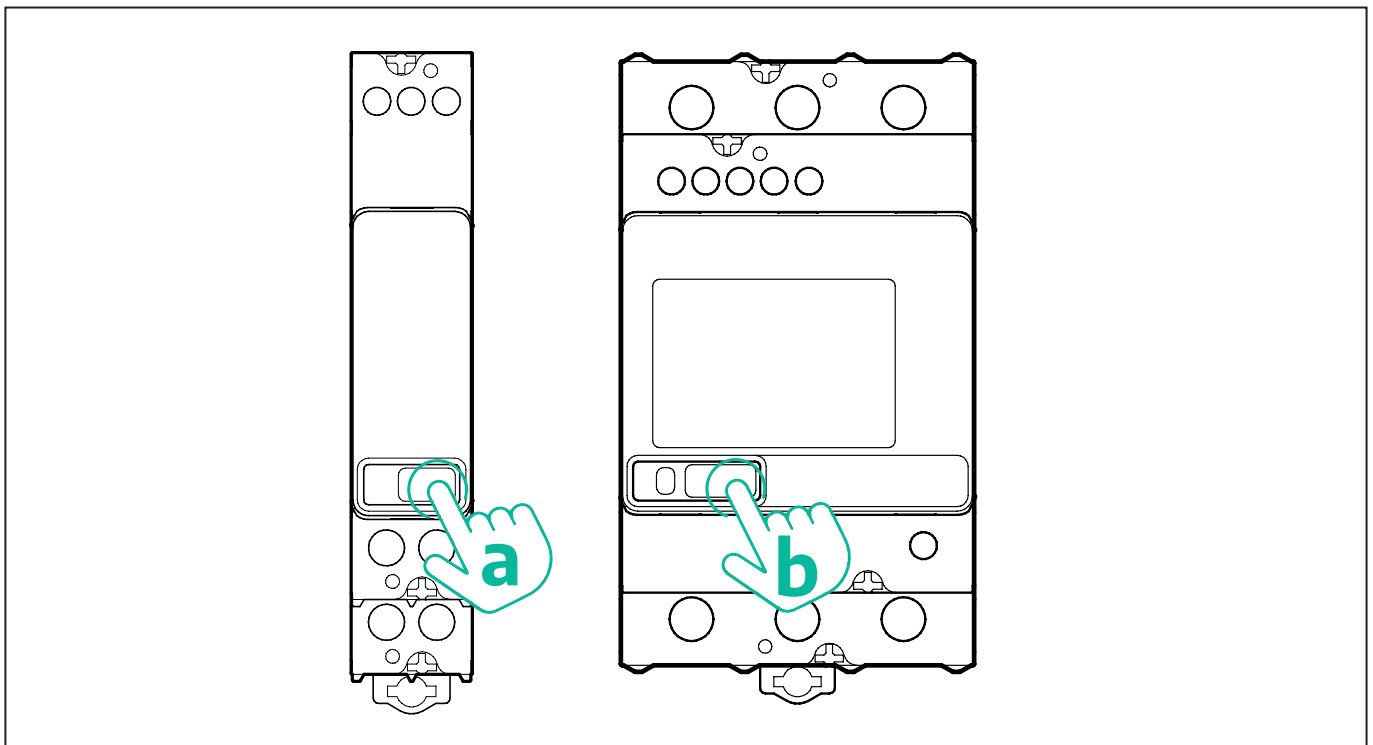

Follow the next steps to correctly configure the single-phase or three-phase Finder energy meters:

- When powering up the energy meter for the first time, long press the touchscreen button (a,b) until the display text blinks in order to enter the "MAIN" menu;
- Scroll the "MAIN" menu pressing the touchscreen button (a,b), then select "SETTING" ("SET" on single-phase meter). Long press to enter the selection.
- Scroll the "SETTING" menu pressing the touchscreen button (a,b), then select "COMMUNICATION" ("COMM" on single phase meter). Long press to enter the selection.
- Insert the correct values indicated in the table below. To modify the value press the touchscreen button (a,b), long press to confirm.

Only for three-phase Finder meter (in addition to previous options):

- Long press the touchscreen button (a,b) until the display text blinks in order to enter the "MAIN" menu (or return to the "MAIN" menu)
- Scroll the "MAIN" menu pressing the touchscreen button (a,b), then select "INSTALLATION". Long press the touchscreen button (a,b) to enter the selection
- Scroll the "INSTALLATION" menu pressing the touchscreen button (a,b) and then select the following option
 - "Communication mode" = "3L+N, L+N-Arithmetic"
 - Once the correct option is confirmed, enter the password: "DCBA" **Attention:** configuration cannot be modified after entering the password **DCBA**
 - Confirm the change selecting "Yes" when prompted.

ALL FINDER MODELS	PowerMeter (DPM)	MIDcounter
DEVICE ADDRESS	1	2
BITS PER SECOND (BAUD)	38400 bit/s	38400 bit/s
PARITY	Even	Even
STOP BIT	1	1
Additional for three-phase type		
	PowerMeter (DPM)	MIDcounter
COMMUNICATION MODE	3L+N, L+N-Arithmetic	3L+N, L+N-Arithmetic
PASSWORD	DCBA	DCBA

4.2. Gavazzi models

The following actions help to understand how to set Gavazzi energy meters:

- Press the touchscreen buttons (c, d, e, g) to move between menus and values
- press (~ 2 seconds) the touchscreen button (d, f) to enter the menu and confirm selections

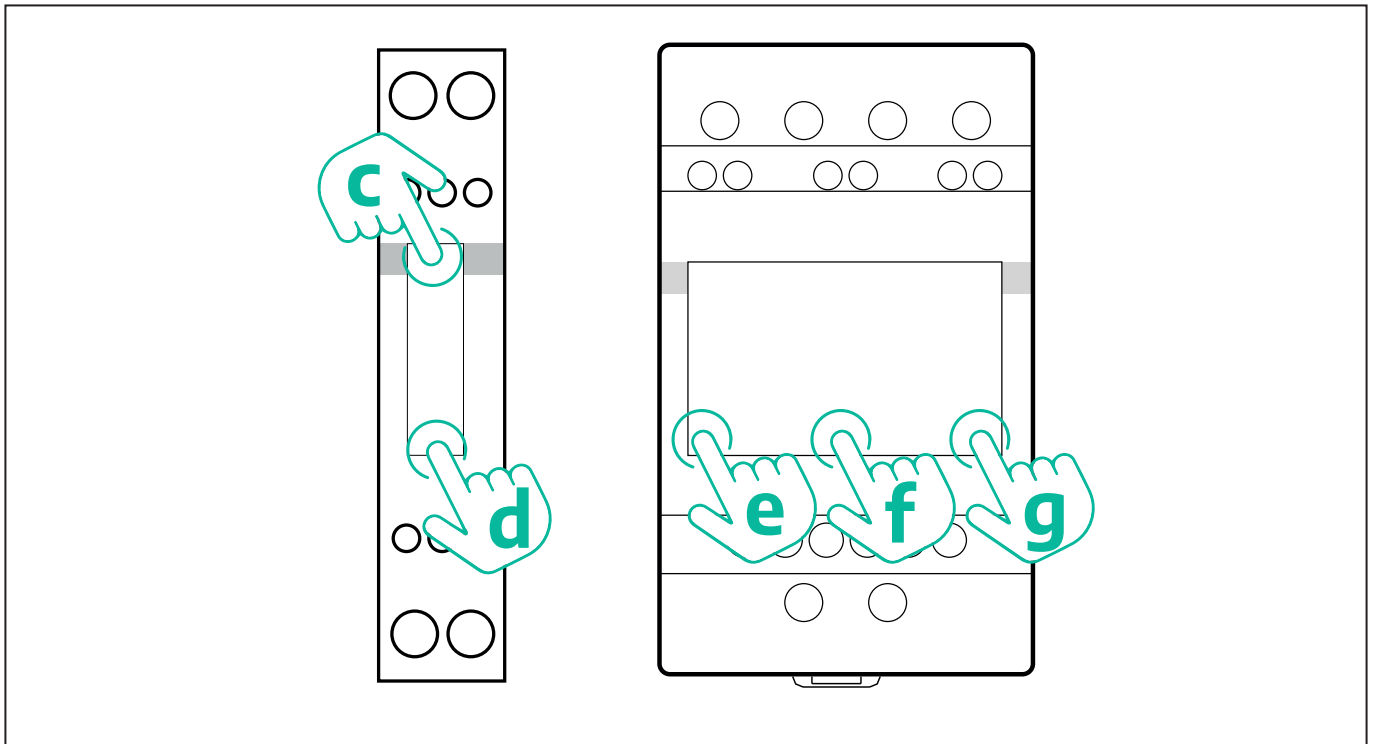

Follow the next steps to correctly configure the single-phase Gavazzi direct and indirect energy meters.

- When powering up the energy meter for the first time, long press the touchscreen button (d) until the password appears on the screen
- Long press the buttons (c, d) simultaneously in order to confirm the password "0000" and enter the "MAIN" menu
- Scroll the "MAIN" menu pressing the upper button (c) and then select the following options in the table below

Follow the next steps to correctly configure the three-phase Gavazzi direct and indirect energy meters:

- When powering up the energy meter for the first time, long press the central button (f) until the password appears on the screen;
- Long press the buttons (e, g) simultaneously in order to confirm the password "0000" and enter the "MAIN" menu
- Scroll the "MAIN" menu pressing the buttons (e or g) and then select the options in the table below

ALL GAVAZZI MODELS	PowerMeter (DPM)	MIDcounter
PASS	0000	0000
ADDRESS	001	002
BAUD	38.4	38.4
PARITY	Even	Even
Additional for three-phase type		
	PowerMeter (DPM)	MIDcounter
SYSTEM	3Pn	3Pn
ADDRESS	001	002

4.3. Device configuration summary

EM340DINAV23XS1PFB / EM330DINAV53HS1X		EM340DINAV23XS1PFB	
PASS	0000	PASS	0000
SYSTEM	3Pn	SYSTEM	3Pn
ADDRESS	1	ADDRESS	2
BAUD	38.4	BAUD	38.4
PARITY	EVEN	PARITY	EVEN

EM111DINAV81XS1PFB / EM111DINAV51XS1X / EM111DINMV51XS1X		EM111DINAV81XS1PFB	
PASS	0000	PASS	0000
ADDRESS	001	ADDRESS	002
BAUD	38.4	BAUD	38.4
PARITY	EVEN	PARITY	EVEN

7M 24.8.230.0210		7M 24.8.230.0210	
DEVICE ADDRESS	__ 1	DEVICE ADDRESS	__ 2
BITS PER SECOND (BAUD)	38400 bit/s	BITS PER SECOND (BAUD)	38400 bit/s
PARITY	EVEN	PARITY	EVEN
STOP BIT	1	STOP BIT	1

7M.38.8.400.0212		7M.38.8.400.0212	
DEVICE ADDRESS	__ 1	DEVICE ADDRESS	__ 2
BITS PER SECOND (BAUD)	38400 bit/s	BITS PER SECOND (BAUD)	38400 bit/s
PARITY	EVEN	PARITY	EVEN
STOP BIT	1	STOP BIT	1
CONNECTION MODE	3L+N, L+N - Arithmetic	CONNECTION MODE	3L+N, L+N - Arithmetic
PASSWORD	DCBA	PASSWORD	DCBA

4.4. PowerMeter (DPM) and MIDcounter configuration on APP

To complete installation, the final configuration of the **eLuxWallbox** and its accessories should be set via the dedicated app

PowerUp is a smartphone app for qualified installers only, available via Google Play™ and Apple Store®. The configuration is carried out via a Bluetooth connection. The wallbox cannot operate correctly if not configured via the app.



NOTICE: Make sure you have the latest version of PowerUp to have access to all of the features.

Follow the instructions below to get started with the app:

Download PowerUp to your smartphone and activate Bluetooth on the smartphone.



Scan **eLuxWallbox** QR code to pair it with the app. The QR Code can be found on the side of the charger.

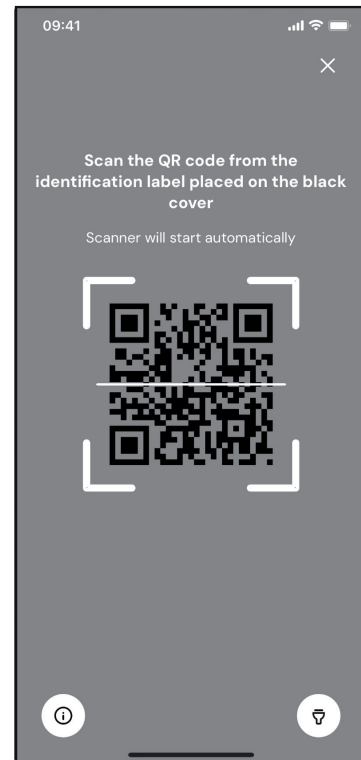

Once paired, complete the configuration set up of **eLuxWallbox** and its Accessories by clicking on the parameter to be configured.

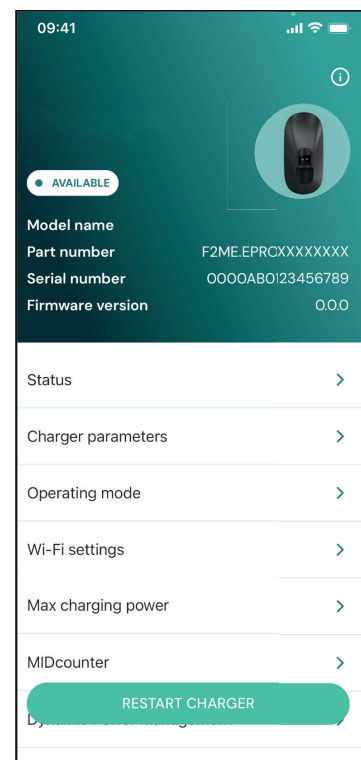

4.5. PowerMeter (DPM) configuration

To complete installation of the **PowerMeter (DPM)**, follow the steps below:

Select "**DPM PowerMeter**" on the homepage

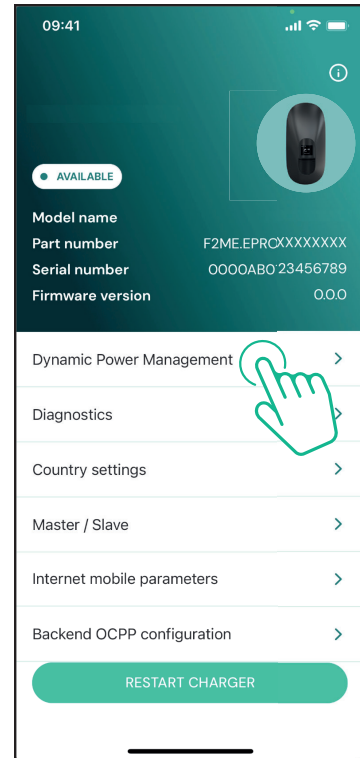

Select the **PowerMeter** type from the drop-down menu, matching the model installed.

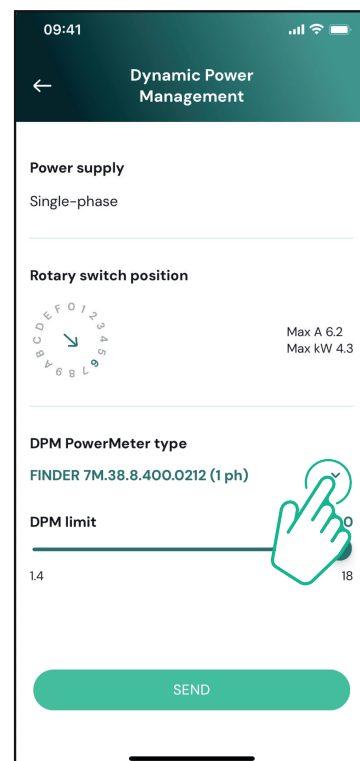

Enter the value of the user contractual power as **DPM** power limit.

For Indirect Meter only - Set the CT current ratio with the slider.

- With CTV 60 A set 60 as Current ratio
- With CTA 100 A set 20 as Current ratio
- With CTA 150 A set 30 as Current ratio

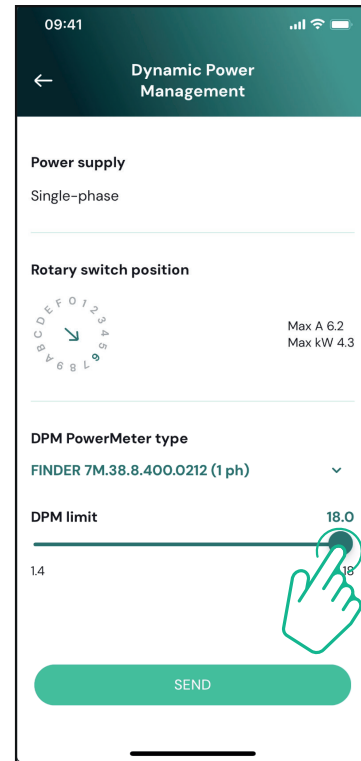

Click "Send" and confirm on the pop-up to restart **eLuxWallbox**.

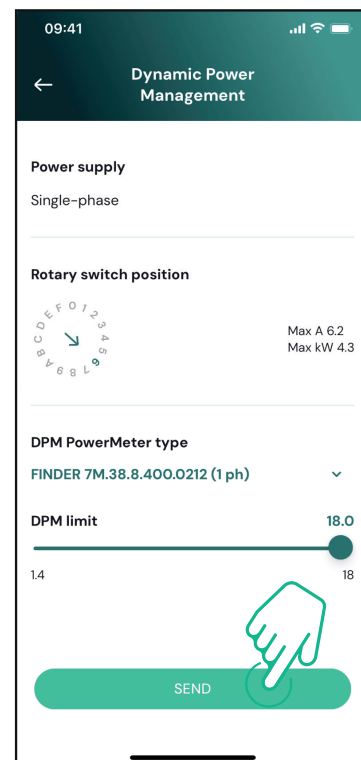

4.6. MIDcounter configuration

To complete installation of the **MIDcounter**, follow the steps below:

Select "**MIDcounter**" on the homepage

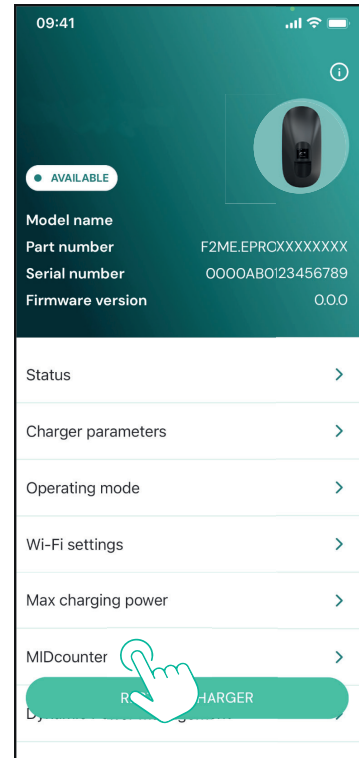

Select the **MIDcounter** type from the drop down menu, based on the model installed.

Select "OFF" from the drop down menu to disable the **MIDcounter** configuration.

Click "Send" to confirm.

To make the changes effective, click on the back arrow in the top left corner and restart **eLuxWallbox** through the dedicated button in the homepage.

If the installation has both the **PowerMeter (DPM)** and the **MIDcounter** it is possible to proceed with **DPM** configuration before restarting.

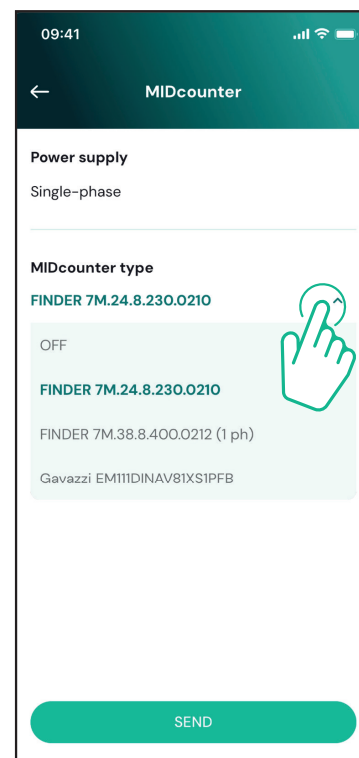

5. TROUBLESHOOTING

Error conditions are stored in the diagnostic logs and shown on the charger panel:

- On the **eLuxWallbox Move** model, the LED bar blinks red. See the **Diagnostic** section of PowerUP or the end-user App for the detailed error code.
- On the **eLuxWallbox** model, the display shows the error code, which is also available in the **Diagnostic** section of PowerUP.

When an error occurs, the charge is interrupted, and the socket is unlocked to allow you to disconnect the plug.

The following table provides a list of errors that can occur and the relative troubleshooting. If the error persists, note the serial number on the charger label and contact Customer Service.

Error code / issue	"Error Description"	Troubleshooting
100	Lack of power supply	<p>Check if the circuit breaker is ON. Check that the CN1 cabling is correct. Check the voltage in CN1.</p>
101	Overheating	<p>Disconnect the Type 2 cable, wait for the temperature to drop, then the error will clear.</p> <p>To restart the charging session, plug in the cable again. Make sure that installation site is compatible with temperature range (25°C/+50°C without direct exposure to sunlight)</p>
102	Communication error between MCU and MPU.	<p>Restart the charger from the circuit breaker, leaving the charger switched off for at least 60 seconds.</p>
103	Hardware fault, ground protection device error (GPD error)	<p>Check the cabling on CN1:</p> <ul style="list-style-type: none"> - in single-phase, make sure that ground cable is connected to PE, the Neutral cable is connected to N and the phase cable to T - in three-phase, make sure that the ground cable is connected to PE, the Neutral cable is connected to N and the phase cables L1, L2 and L3 are connected to T, S, and R. <p>Check whether the voltage difference between PE and N does not exceed 10V. Check PE connection</p> <p>If all connections are checked and the error persists, open the charger and modify the configuration of the Dipswitch (SW2) connector.</p>

104	Hardware fault, residual current monitor AC error. (RCM AC trip)	<p>Try to start a new charging session, removing and plugging in all the connectors.</p> <p>If the problem persists, check for the presence of any problems in the charging cable or vehicle inlet.</p> <p>If the cables and the EV don't show any problem, check CN27 connector and RCM cable.</p>
105	Hardware fault, residual current monitor DC error. (RCM DC trip)	<p>Check that the problem is not with the cable or vehicle. If possible, try another charging session with a different cable or vehicle.</p>
106	Internal meter error	<p>Restart the charger from the circuit breaker, leaving the charger switched off for at least 60 seconds.</p>
107	PowerMeter (DPM) communication error	<p>Check that the communication configuration on the DPM PowerMeter device is correct.</p> <p>Check that the DPM model configuration in the installer App is correct.</p> <p>Check the communication cable wiring on CN12.</p> <p>Check that the communication cable used is suitable for Modbus RS485 and cable length.</p>
108	Configuration Error, Rotary switch position (supply type) is not consistent with the DPM/ MID type.	<p>Check the position of the rotary switch. If it is not consistent with the 1-ph/3-ph installation, change it according to the table in the manual, then restart the charger.</p> <p>If the accessories (DPM/MID) are not installed, make sure that the function is disabled in the installer App.</p> <p>If the accessories (DPM/MID) are installed, check that the correct model is selected on the installer App. Then restart the charger.</p>
109	Main/secondary RS485 communication error	<p>Check the configuration of the Main/Secondary set up from installer App.</p> <p>Check that the Main charger is available.</p> <p>Check that the wiring of the communication cable on CN9 and CN10 is correct.</p> <p>Check that the communication cable used is suitable for Modbus RS485.</p>

110	MIDcounter communication error	<p>Check that the communication configuration on the MIDcounter device is correct.</p> <p>Check the communication cable wiring on CN12.</p> <p>Check that the communication cable used is suitable for Modbus RS485.</p> <p>Check that the MID model configuration in the installer App is correct.</p>
300	Inconsistency between the charger contactor command and feedback	<p>Restart the charger from the circuit breaker, leaving the charger switched off for at least 60 seconds.</p> <p>If error persists even after restart, call Customer Service.</p>
301	Short circuit detected on the Control Pilot line.	<p>With the charger switched off, check that there is no damage and no defects inside and outside the socket (if so, avoid using the charger and contact Customer Service).</p> <p>Check that the problem is not related to the cable or vehicle and try another charge session (with another vehicle or cable if possible).</p>
302	State E or F set on the Control Pilot line.	<p>With the charger switched off, check that there is no damage and no defects inside and outside the cable and its connectors (if so, avoid using it and attempt charge with another cable).</p>
303	Control Pilot disconnected.	<p>Check that the cable connectors are fully inserted inside the charger socket and vehicle inlet.</p>
304	Proximity Pilot disconnected.	<p>Check that the problem is not related to the cable or vehicle and try another charge session (with another vehicle or cable if possible).</p>
305	Broken Proximity Pilot detected.	<p>Check that the problem is not related to the cable or vehicle and try another charge session (with another vehicle or cable if possible).</p>
306	Diode fault detected on Control Pilot line (no - 12V).	<p>Attempt a new charging session unplugging and reinserting the cable from both the charger and vehicle inlet.</p>
307	Control Pilot disconnected.	<p>With the charger switched off, check that there is no damage and no defects inside and outside the cable and its connectors (if so, avoid using it and attempt charge with another cable).</p> <p>Check that the cable connectors are fully inserted inside the charger socket and vehicle inlet.</p> <p>Check that the problem is not related to the cable or vehicle and try another charge session (with another vehicle or cable if possible).</p>

308	Inconsistency between the motor command and feedback, or the motor is in an error condition.	<p>Attempt a new charging session unplugging and reinserting the cable from both the charger and vehicle inlet.</p> <p>Check that the cable connectors are fully inserted inside the charger socket and vehicle inlet.</p>
309	Motor check error during EVSE initialization phase.	Restart the charger from the circuit breaker, leaving the charger switched off for at least 60 seconds.
310	Error detected before charging (PP not detected, or motor fault, or CP not detected).	<p>With the charger switched off, check that there is no damage and no defects inside and outside the cable and its connectors (if so, avoid using it and attempt charge with another cable).</p> <p>Check that the cable connectors are fully inserted inside the charger socket and vehicle inlet.</p>
311	Error detected after charging (motor fault, or CP not disconnected).	Check that the problem is not related to the cable or vehicle and try another charge session (with another vehicle or cable if possible).
312	Emergency stop received from the MPU.	Restart the charger from the circuit breaker, leaving the charger switched off for at least 60 seconds.
313	Current detected during charging, with 100% duty cycle on the Control Pilot line.	Check that the problem is not cable nor vehicle related, attempt a new charging session with another cable and/or charger.
315	Current over limits on phase L1	Unplug the cable, if possible lower the power of charge on the vehicle side and attempt a new charging session.
316	Current over limits on phase L2	
317	Current over limits on phase L3	
318	Voltage below a threshold on phase L1	<p>Check the rotary switch position is consistent with 1-ph/3-ph installation.</p> <p>Check that the voltage on CN1-T is above 196 V.</p> <p>If the voltage is below 196 V, check the electric system or contact the energy supplier.</p> <p>If an error occurs during vehicle charging, try to reduce the set-up charging power and verify that the electric system is correctly dimensioned for the power drawn by the vehicle.</p>

319	Voltage below a threshold on phase L2	The rotary switch is in a three-phase position. Check that the intended installation is in three-phase. If not, select the correct rotary switch position as per Installation Manual.
320	Voltage below a threshold on phase L3	<p>Check that the voltage on CN1-S and R is above 196 V. If the voltage is below 196V, check the electric system or contact the energy supplier.</p> <p>If an error occurs during vehicle charging, try to reduce the set-up charging power and verify that the electric system is correctly dimensioned for the power drawn by the vehicle.</p>
321	Forbidden state change (IEC 61851-1)	<p>EV does not meet IEC 61851-1 standards for starting a charge session.</p> <p>Attempt a new charging session unplugging and reinserting the cable from both the charger and vehicle inlet.</p> <p>If the error persists, contact the vehicle manufacturer.</p>
	Display/LED stuck in Welcome mode (LED blinks red-green-blue)	Restart the charger from the circuit breaker, leaving the charger switched off for at least 60 seconds.
	LED or display does not light up at startup	
	The charger does not start	<p>Let the unit restart, it may take up to 30 seconds.</p> <p>Check if the circuit breaker is ON.</p> <p>Check that the CN1 cabling is correct.</p> <p>Check the voltage in CN1.</p> <p>Restart the charger from the circuit breaker, leaving the charger switched off for at least 60 seconds.</p>
	Cable stuck in the charger socket	Turn off the charger from the circuit breaker, then remove the cable.
	Suspended Charging with solid green LED/ message on the display. The charging session is suspended by the DPM or the EV. The session may resume.	<p>Verify that the max power in the DPM power limit section of the installer App is consistent with the contract power value in kW as indicated in the user's electricity contract. If the value is correct, wait for the charging session to resume or turn off some house loads.</p> <p>In the case of 3-ph installation, verify that the electrical loads are well balanced on the phases of the domestic system.</p>

	<p>App pairing does not complete after QR scan.</p>	<p>Check the integrity of the QR code on the label. Update the App to the latest version. Close and restart the App, then try again. Restart the charger from the circuit breaker, leaving the charger switched off for at least 60 seconds.</p>
--	---	---

6. CLEANING

Cleaning the outside of the device is always recommended when necessary and should be carried out using a soft damp cloth with a mild detergent. When finished, wipe off any traces of moisture or liquid with a soft dry cloth.



CAUTION: Avoid strong jets of air or water as well as the use of soaps or detergents that are too harsh and corrosive for the materials of the charger.

7. PACKAGING DISPOSAL



Dispose of packaging in an environmentally friendly manner. The materials used for packaging this product can be recycled and must be disposed of in compliance with the legislation in force in the country of use. The following disposal directions will be found on the packaging based on the type of material.



NOTE: Further information about current disposal facilities can be obtained from local authorities.

8. ASSISTANCE

If you have any questions about the installation of **eLuxWallbox**. For any other information or requests for support, please contact Free2move eSolutions S.p.A. through the relevant section of its website: www.esolutions.free2move.com.

9. DISCLAIMER

Free2move eSolutions S.p.A. will not be held responsible for any damage directly or indirectly caused to people, things or animals due to the failure to comply with all the provisions set out in this Manual, and the warnings regarding the installation and maintenance of **eLuxWallbox**.

Free2move eSolutions S.p.A. reserves all rights to this document, the article and the illustrations it contains. The reproduction, whole or in part, disclosure to third parties or use of its contents is prohibited without the prior written consent of Free2move eSolutions S.p.A.

Any information in this manual may be changed without prior notice and does not represent any obligation on the part of the manufacturer. Images in this manual are for illustrative purposes only and might differ from the delivered product.

EN

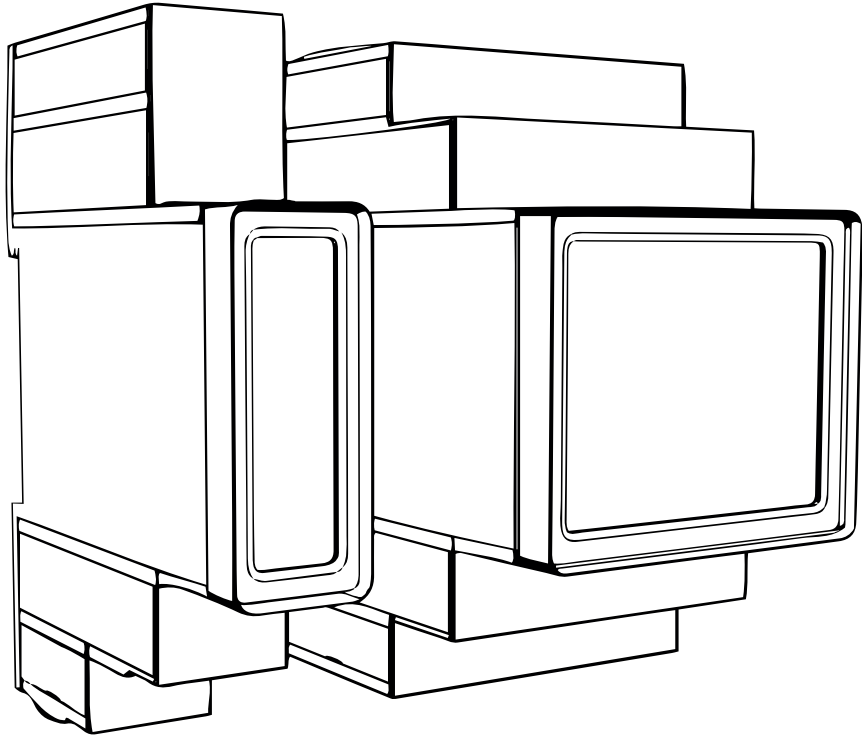
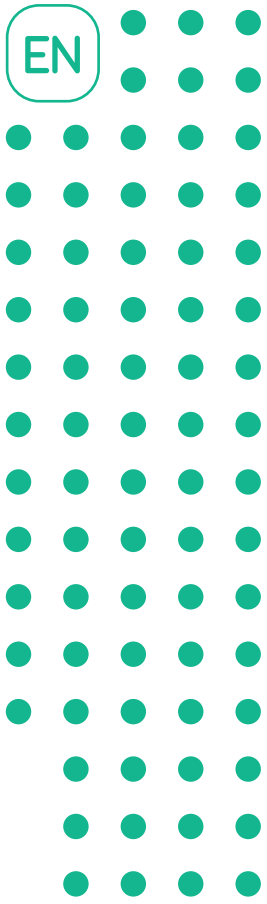

LuxWallbox

Accessories Manual



For safe and proper use,
follow these instructions.
Keep them for future reference

Table of content

1. INTRODUCTION	4
1.1. Purpose of the Manual	4
1.2. Identification of the Manufacturer.....	4
1.3. Structure of the Accessories Manual	4
1.4. Safety	5
1.5. Personal Protective Equipment (PPE).....	6
1.6. Warranty and delivery conditions	6
1.7. List of documents.....	7
1.8. Warnings	7
2. GENERAL INFORMATION	8
2.1. Fields of use	9
3. ACCESSORIES INSTALLATION	10
3.1. Installing PowerMeter (DPM).....	10
3.2. Installing MIDcounter	15
3.3. Communication cable installation	17
3.4. MIDcounter and PowerMeter (DPM) combined installation .	19
4. PowerMeter (DPM) and MIDcounter configuration.	22
4.1. Finder models.....	22
4.2. Gavazzi models.....	24
4.3. Device configuration summary	25
4.4. PowerMeter (DPM) and MIDcounter configuration on APP ..	26
4.5. PowerMeter (DPM) configuration	28
4.6. MIDcounter configuration.....	30
5. TROUBLESHOOTING.....	31
6. CLEANING.....	36
7. PACKAGING DISPOSAL	36
8. ASSISTANCE.....	37
9. DISCLAIMER.....	37



1. INTRODUCTION

1.1. Purpose of the Manual

This installation manual is a guide to help operators to work safely and carry out the installation operations needed to keep the charger in good working order.

The purpose of this document is to support qualified technicians who have received appropriate training, and demonstrated suitable skills and knowledge in the construction, installation, operation and maintenance of electrical equipment.

If the charger is used in a manner not specified in this manual, the protection provided by the charger may be impaired. This document contains the information required for the installation of the charger.

This document has been carefully checked by the Manufacturer Free2move eSolutions S.p.A. but oversights cannot be completely ruled out. If any errors are noted, please inform Free2move eSolutions S.p.A. Except for explicit contractual obligations, under no circumstances may Free2move eSolutions S.p.A. be held liable for any loss or damage resulting from the use of this manual, or from installation of the equipment. This document was originally written in English. In the event of any inconsistencies or doubts, please ask Free2move eSolutions S.p.A. for the original document.

1.2. Identification of the Manufacturer

The manufacturer of the charger is:

Free2move eSolutions S.p.A.

Piazzale Lodi, 3

20137 Milan – Italy

www.esolutions.free2move.com

1.3. Structure of the Accessories Manual





This manual is divided into chapters based on different topics and containing all the information that is needed to install the charger safely.

Each chapter is sub-divided into paragraphs which examine the fundamental points, and each paragraph may have its own title, along with sub-titles and a description.

1.4. Safety

This manual contains important safety instructions that must be followed during installation of the charger.

In order to fulfil this objective, this manual contains a number of precautionary texts, containing special instructions. These instructions are highlighted by a specific text box and are accompanied by a symbol, and are provided in order to ensure the safety of the personnel required to perform the operations described, and to avoid any damage to the charger and/or property:

	<p>This symbol means: DANGER</p> <p>This symbol is intended to highlight a dangerous situation for yourself and others. Read it carefully. Failure to comply with the instruction will result in an imminent hazardous situation which, if not avoided, will result in instant death, or serious or permanent injury.</p>
	<p>This symbol means: WARNING</p> <p>This symbol is intended to highlight safety information. Failure to comply with the instruction will result in a potentially hazardous situation which, if not avoided, could result in death or serious injury.</p>
	<p>This symbol means: CAUTION</p> <p>This symbol is intended to highlight safety information. Read it carefully. Failure to follow these instructions can result in death, serious injury or damage to equipment.</p>
	<p>This symbol means: NOTE</p> <p>Provides additional information to supplement instructions provided.</p>
	<p>This symbol means: NOTICE</p> <p>Provides instructions concerning the use of conduct necessary to handle the operations not associated with possible physical injuries.</p>

Installation must be carried out by qualified personnel. A dedicated, state-of-the-art electricity supply system must be designed and installed, and the system must be certified in compliance with local regulations and the energy supply contract.

Operators are required to read and fully understand this manual, and to comply strictly with the instructions it contains.

Free2move eSolutions S.p.A. cannot be held liable for damage caused to persons and/ or property, or to the equipment, if the conditions described in this document have not been complied with.





WARNING: Installation must be carried out in accordance with the regulations in force in the country of installation, and in compliance with all safety regulations for carrying out electrical work.

1.5. Personal Protective Equipment (PPE)

Personal Protective Equipment (PPE) means any equipment intended to be worn by the workers in order to protect them against one or more hazards likely to threaten their health or safety at the workplace, as well as any device or accessory intended for this purpose.

Since all the PPE indicated in this manual is intended to protect the personnel against health and safety hazards, the Manufacturer of the charger which is the subject of this manual recommends strict compliance with the indications contained in the various sections of this manual.

The list of PPE to be used in order to protect the operators against the residual risks present during the installation and maintenance interventions described in this document is provided below.

Symbol	Meaning
	Wear protective gloves
	Wear anti-static footwear



WARNING: It is responsibility of the operator to read and understand local regulations and evaluate the environmental conditions of the installation site in order to comply the need to wear additional PPE.

1.6. Warranty and delivery conditions

The warranty details are described in the Terms and Conditions of Sale included with the purchase order for this product and/or in the packaging of the product.

Free2move eSolutions S.p.A. assumes no responsibility for failure to comply with the instructions for proper installation, and cannot be held responsible for systems upstream or downstream of the equipment supplied.

Free2move eSolutions S.p.A. cannot be held responsible for defects or malfunctions deriving from: improper use of the charger; deterioration due to transport or particular environmental conditions or installation by unqualified persons.

Free2move eSolutions S.p.A. is not responsible for any disposal of the equipment, or parts thereof, that does not comply with the regulations and laws in force in the country of installation.



NOTICE: Any modification, manipulation or alteration of the hardware or software not expressly agreed with the manufacturer will immediately void the warranty.

1.7. List of documents

In addition to this manual, product documentation can be viewed and downloaded by visiting: www.esolutions.free2move.com.

1.8. Warnings



DANGER: Risk of electric shock and fire. Installation must be carried out in accordance with the regulations in force in the country of installation, and in compliance with all safety regulations for carrying out electrical work.

- Before installing or using the device, make sure that none of the components have been damaged. Damaged components can lead to electrocution, short circuits, and fire due to overheating. A device with damage or defects must not be used.
- Install **eLuxWallbox** away from petrol cans or combustible substances in general.
- Before installing **eLuxWallbox compatible accessories**, ensure the main power source has been disconnected.
- The **eLuxWallbox compatible accessories** must only be used for the specific applications they are designed for.
- Installation not carried out correctly may pose risks to the user.
- The charger must be connected to a mains network in compliance with local and international standards, and all the technical requirements indicated in this manual.
- Children or other persons not able to gauge risks related to the installation of the charger could suffer serious injury or put their lives at risk.
- Pets or other animals must be kept away from the device and packaging material
- Children must not play with the device, accessories or packaging provided with the product.
- The only part that can be removed from **eLuxWallbox**, is the removable cover. Access under the cover is only permitted by qualified personnel during installation, dismantling or maintenance.
- **eLuxWallbox** can only be used with an energy source.
- Necessary precautions to ensure safe operation with Active Implantable Medical Devices must be taken. To determine whether the charging process could adversely affect the medical device, please contact its manufacturer.

2. GENERAL INFORMATION

eLuxWallbox is an Alternate Current charging solution for powering electric vehicles and hybrid plug-ins, and is ideal for semi-public and residential use. The charger is available in three-phase or single-phase configurations and is equipped with a Type 2 socket.

The charger charges electric vehicles up to 22 kW in three-phase, or up to 7.4 kW in single-phase. The charger includes connectivity options such as remote monitoring via the eSolutions control platform (CPMS). Its final configuration must be completed using the **PowerUp** application. For the end user, the **eLuxWallbox** can be managed via the dedicated user's eSolutions Charging App. Both applications are available on Google Play™ and Apple Store®.

This charger is equipped with a SIM card for connection to the 4G mobile network.

The SIM card is automatically activated the first time the charger is turned on.

This document describes how to install the external accessories compatible with the **eLuxWallbox**.

The external accessories described in this manual are:

- **PowerMeter (DPM)**: an energy meter that enables the Dynamic Power Management (**DPM**) which is a smart function that allows an electric vehicle to be recharged using only the power available at home, modulating the charging power and avoiding unpleasant blackouts.
- **MIDcounter**: a certified energy meter that allows to monitor the consumption of the **eLuxWallbox** during each charging session.

This manual contains a description of the characteristics of the different accessories, information on models, installation process and final configuration of the devices.

The **eLuxWallbox** is configured to be used with the following electrical accessories: **PowerMeter (DPM)** or **MIDcounter**:

- Gavazzi, 1-phase, Direct, 32 A
- Finder, 1-phase, Direct, 40 A
- Gavazzi, 3-phase, Direct, 65 A
- Finder, 3-phase, Direct, 80 A

PowerMeter (DPM):

- Gavazzi, 1-phase, Indirect with 1x CT 100 A
- Gavazzi, 1-phase, Indirect with 1x CTV 60 A
- Gavazzi, 3-phase, Indirect with 3x CT 150 A



WARNING: Do not try to install the Electrical Accessories if you are not qualified as a professional electrician. To do so could cause serious danger and harm to you and to the people, property or animals around you.

To complete the installation, it is necessary to configure the **eLuxWallbox** through the dedicated apps:

	Installer's app: PowerUp
Product versions (EU):	EPRO23S224GWBAX
Product versions (UK):	EPRO23S224GWBAS



WARNING: Only Electrical Accessories suggested by Free2move eSolutions S.p.A. are compatible. Installation must be performed by qualified personnel in accordance with local regulations.

2.1. Fields of use

Free2move eSolutions S.p.A. declines all liability for any damage whatsoever due to incorrect or careless actions.

The charger may not be used for any purpose other than the one it is intended to fulfill.

The equipment must not be used by children or people with limited mental or physical abilities, or even by adults or expert professionals if the charger undergoes operations that do not comply with this manual and accompanying documentation.

The charger is a charging device for electric vehicles; the following classification (according to IEC 61851-1) identifies its characteristics:

- Power supply: permanently connected to the AC power supply grid
- Output: Alternate Current
- Environmental conditions: indoor / outdoor use
- Fixed installation
- Protection against electric shock: Class I
- EMC Environment classification: Class B
- Charging type: Mode 3 according to the IEC 61851-1 standard
- Optional function for ventilation not supported

3. ACCESSORIES INSTALLATION

To install the electrical accessories, it is necessary to use Modbus communication cables with the following characteristics:

- Modbus RS485 twisted STP 2x2 AWG24 or S/FTP cat.7 suitable for installation with a 400V power line
- Conductor size: 0.5 mm²
- Stripping length: 10 mm
- Recommended maximum length: 150 m

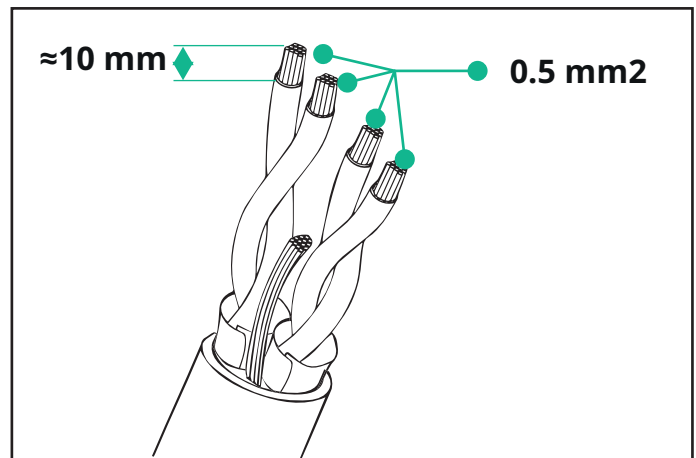

3.1. Installing PowerMeter (DPM)

PowerMeter (DPM) is an energy meter that enables the Dynamic Power Management (**DPM**) which is a smart function that allows an electric vehicle to be recharged using only the power available at home, modulating the charging power and avoiding unpleasant blackouts. Whenever other appliances are being used during the charging session, the system can modulate the charging power towards the car, even temporarily suspending the charging session. As soon as the other domestic appliances are switched off, the session will resume.

The **DPM** smart logic works both in three-phase and in single-phase installations.



WARNING: When installing in three-phase systems, make sure that the electrical loads (including the wallbox) are well balanced between the phases of the electrical system.



WARNING: Before carrying out any installation or maintenance work on the device, it must be ensured that the power supply is switched off.

For Direct models of the PowerMeter (DPM):

Place the **PowerMeter (DPM)** after the main utility meter. The **PowerMeter (DPM)** must measure all the electrical loads, including the **eLuxWallbox**.

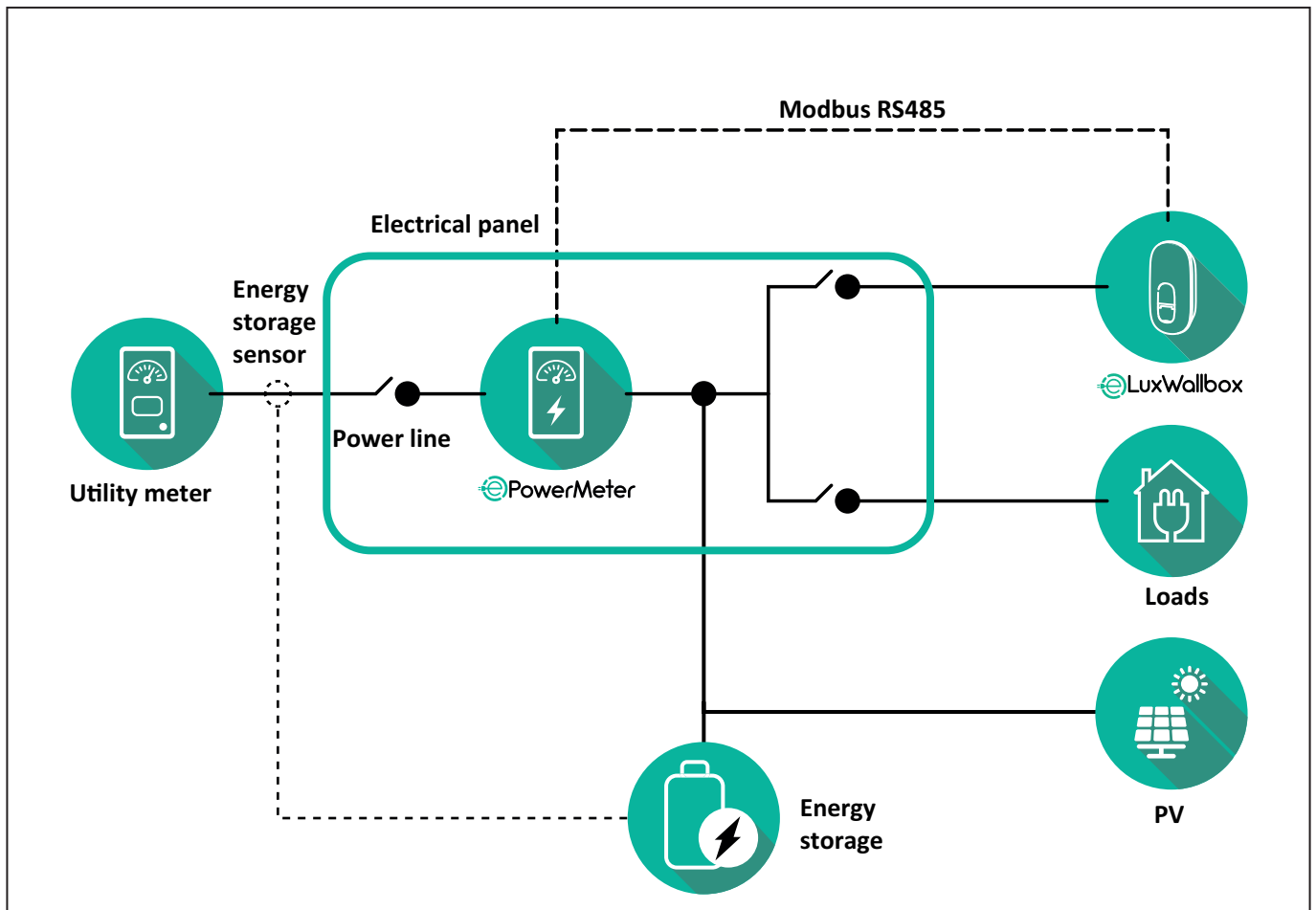

For Direct models of the PowerMeter:



WARNING: During the installation always refer to the manufacturer installation manual provided with the meter.



NOTE: For the single-phase or three-phase electrical connection of the Direct **PowerMeter**, please refer to the diagrams below.

Finder model 1ph and 3ph

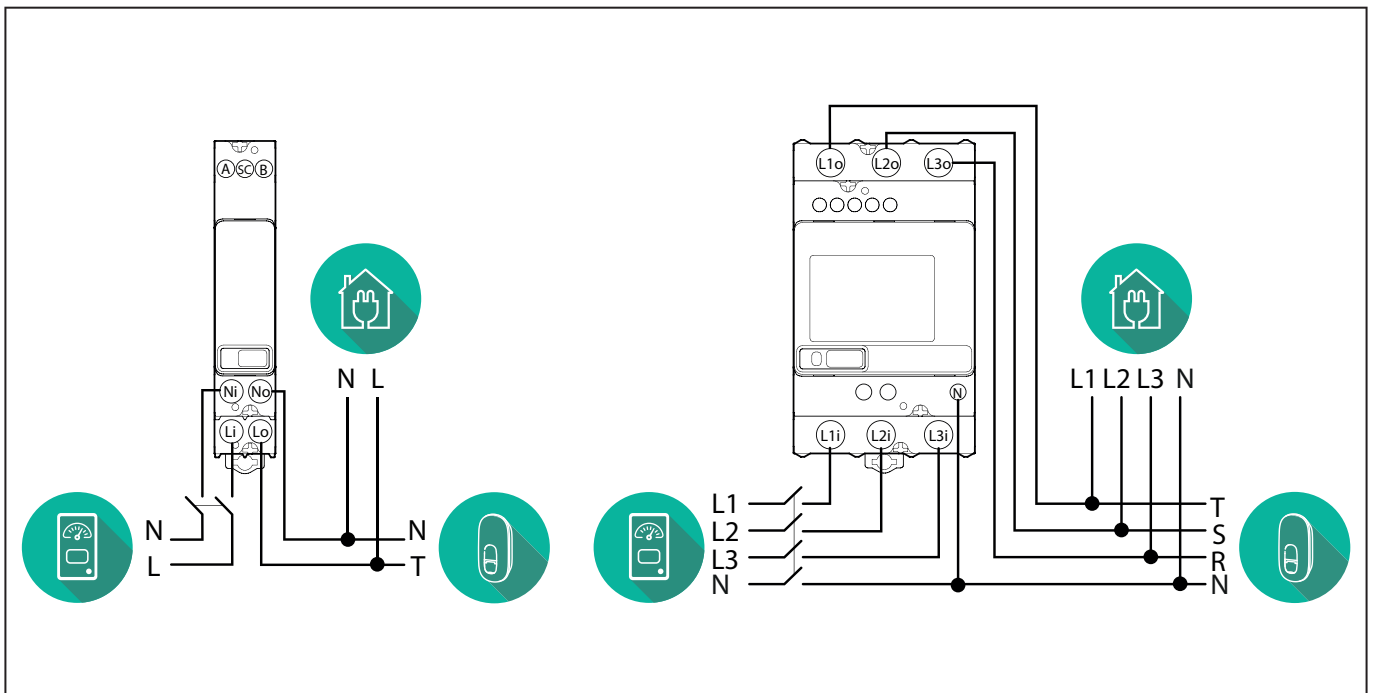

Gavazzi model 1ph and 3ph

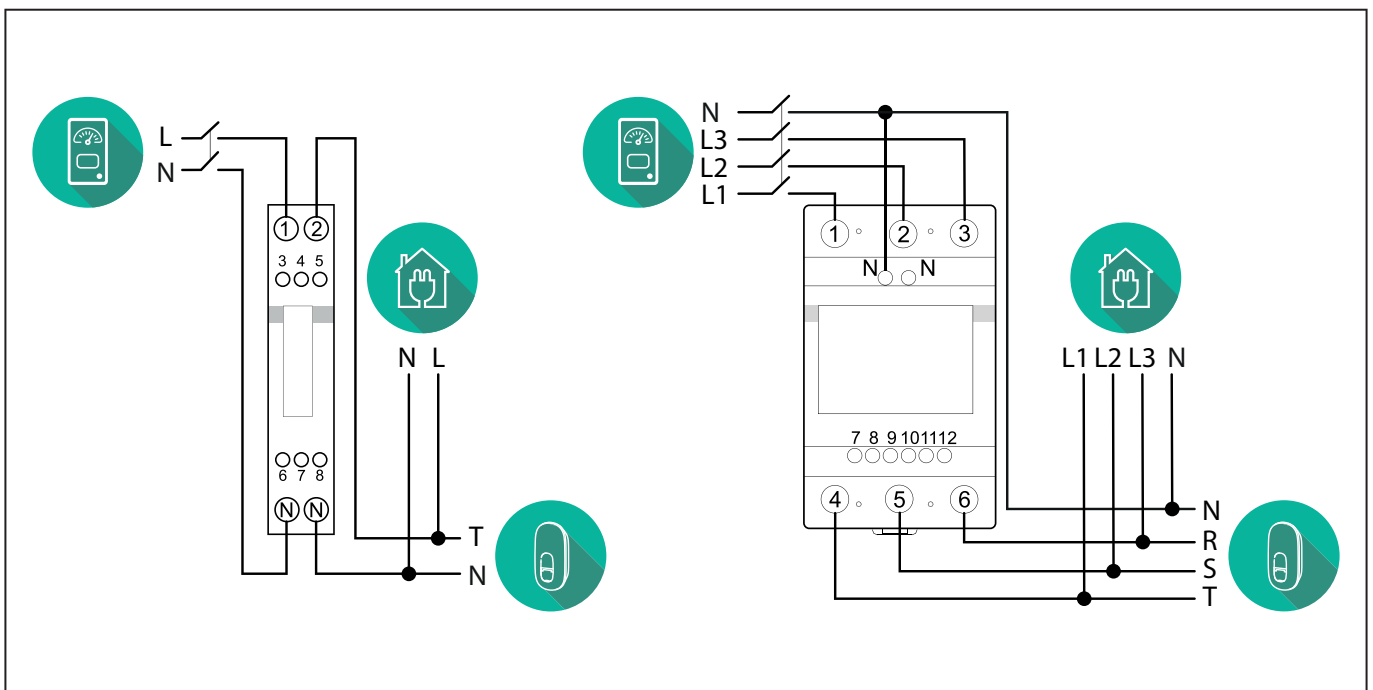

NOTICE:



- 1) If PV is present, the **PowerMeter** should be placed between the Utility Meter and the PV connection point.
- 2) If there is a home Energy storage, the **PowerMeter** should be placed between the Energy storage connection point and the Energy storage measurement sensor.

For Indirect models of the PowerMeter:

Place the CT (current transformer) of the **PowerMeter** after the main utility meter and before the main switch of the house/building. The current transformer must measure all the domestic loads, including the **eLuxWallbox**.

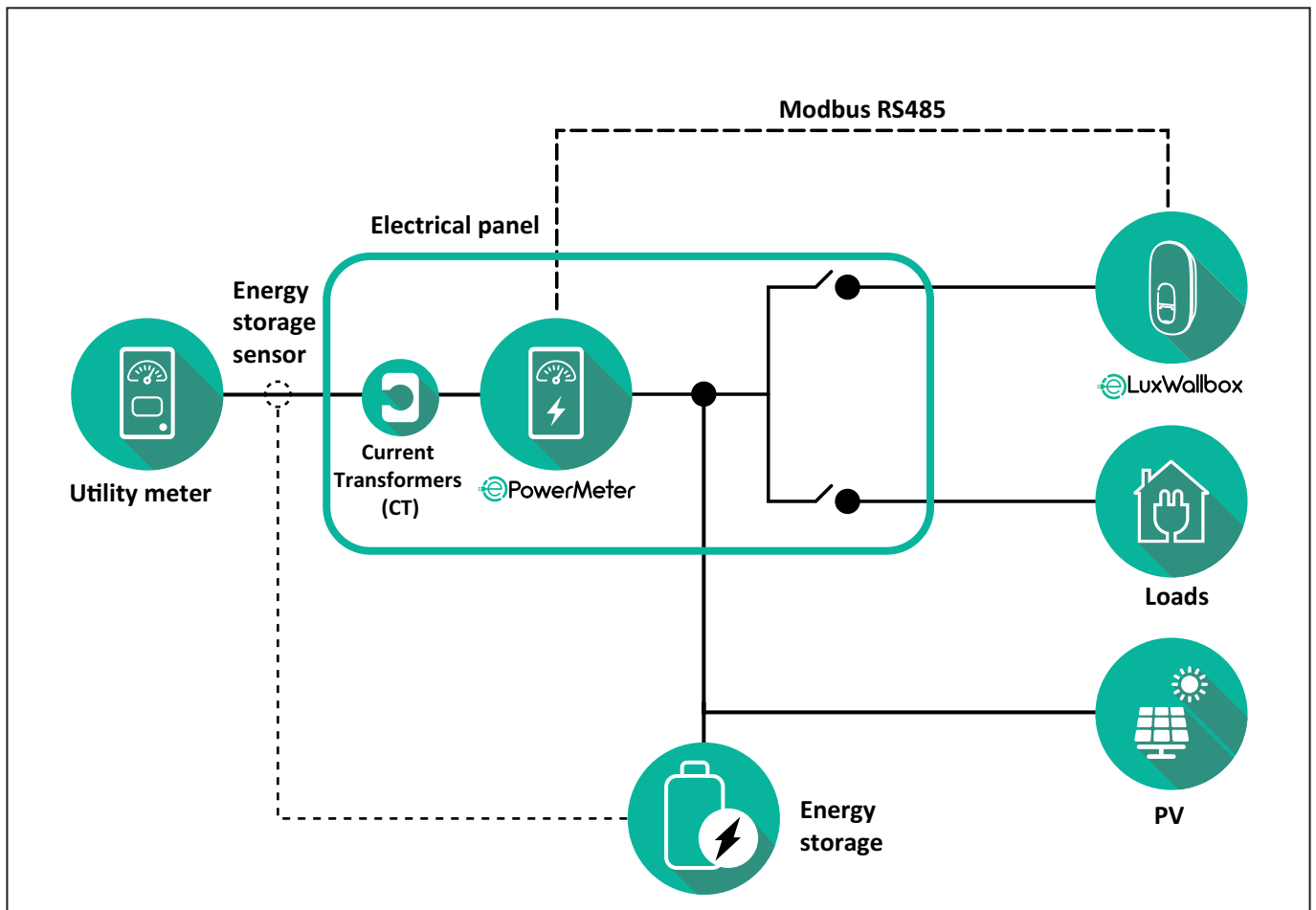

NOTICE:



1) If PV is present, the **PowerMeter** Current Transformers (CT) should be placed between the PV connection point and the Utility Meter.

2) If there is a home Energy storage, the **PowerMeter** Current Transformers (CT) should be placed between the Energy storage connection point and the Energy storage measurement sensor.

Connect the Current Transformers (CT) as indicated in the meter installation manual. Point the arrow on the CT in the direction of the loads.

For the three-phase or single-phase electrical connection of the indirect **PowerMeter**, refer to the diagrams below.

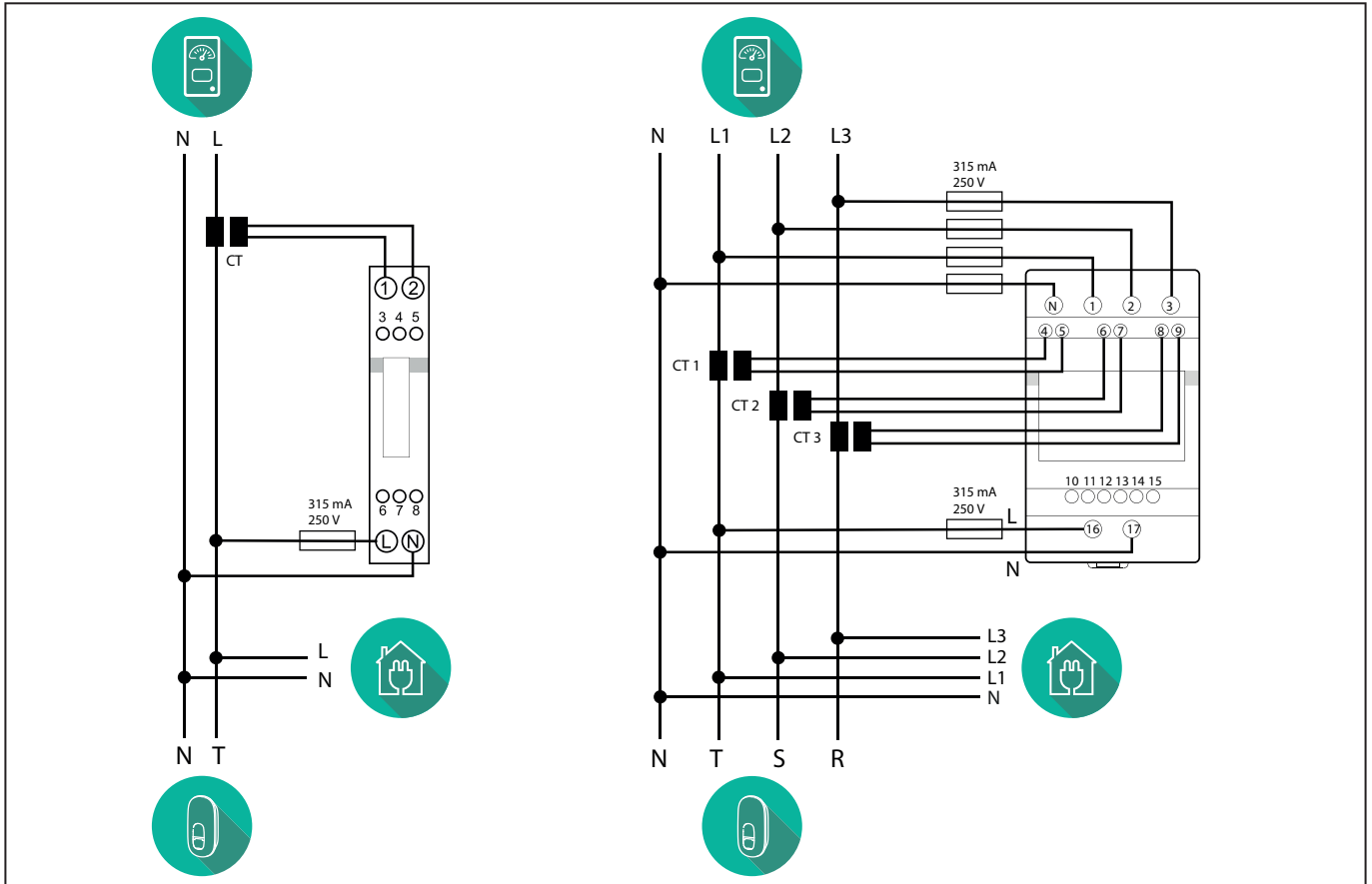

3.2. Installing MIDcounter

The **MIDcounter** is a certified energy meter that allows the consumption of the charger to be safely and reliably monitored during each charging session.

All the relevant data of the charging sessions is automatically recorded by a certified **MID** meter and transferred from the charger to the Charge Point Management System (CPMS).



WARNING: The power to the charger must remain off during this step.

Place the **MIDcounter** on the same power line as the charger, after the electrical protection devices.

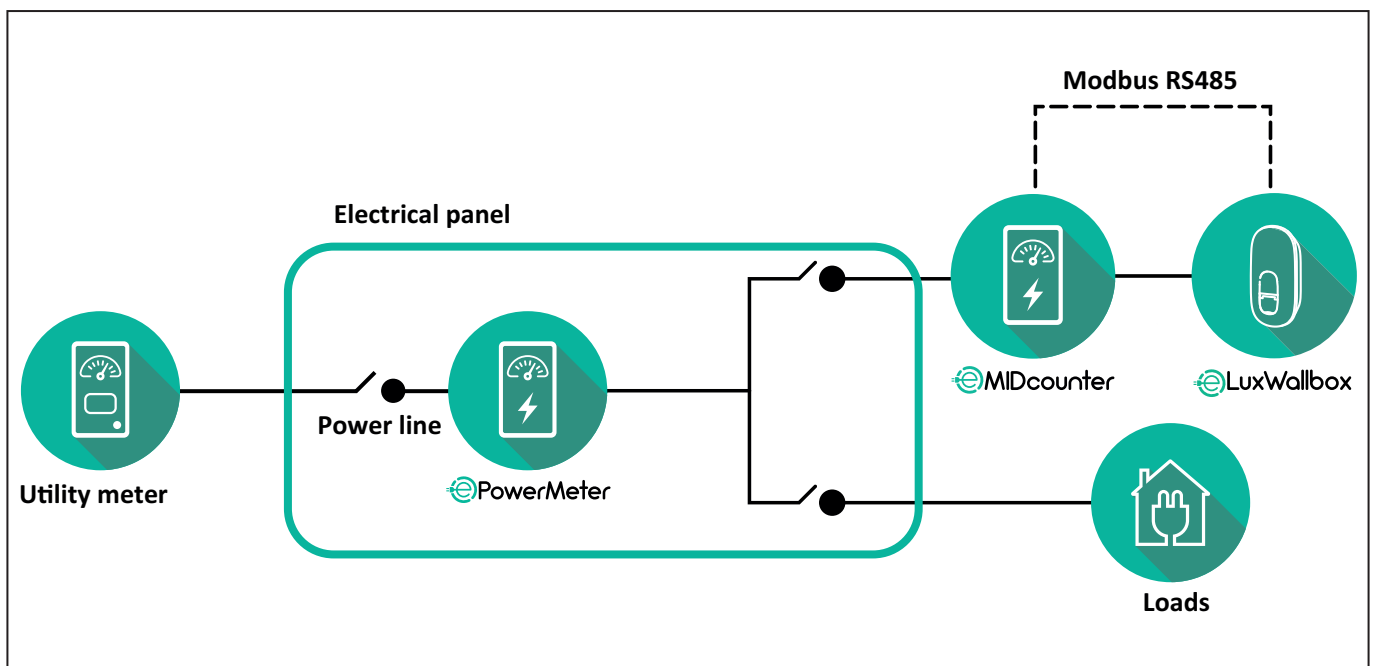

See the diagrams below for single phase and three phase electrical connection of **MIDcounter** (Finder and Gavazzi).

**Finder 1-phase, Direct, 40 A
(7M2482300210)**

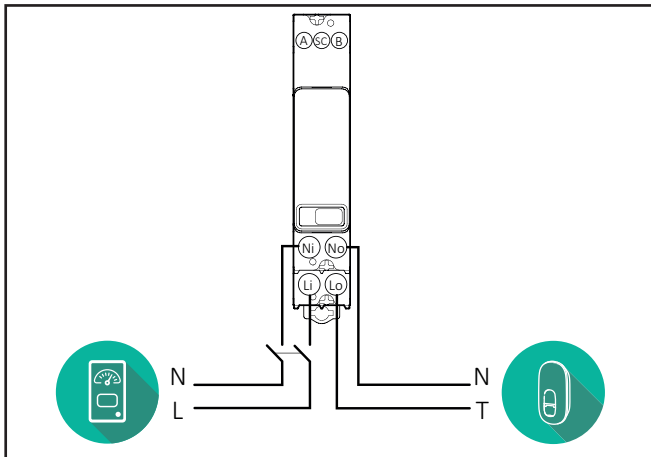

**Gavazzi, 3-phase, Direct, 65 A
(EM340DINAV23XS1PFB)**

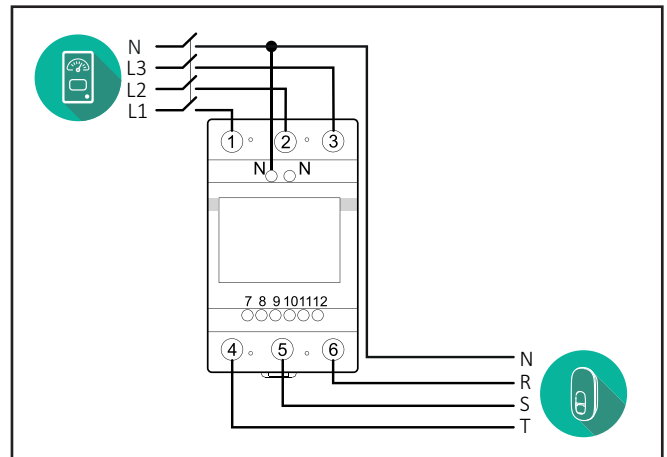

**Finder 3-phase, Direct, 80 A
(7M3884000212)**

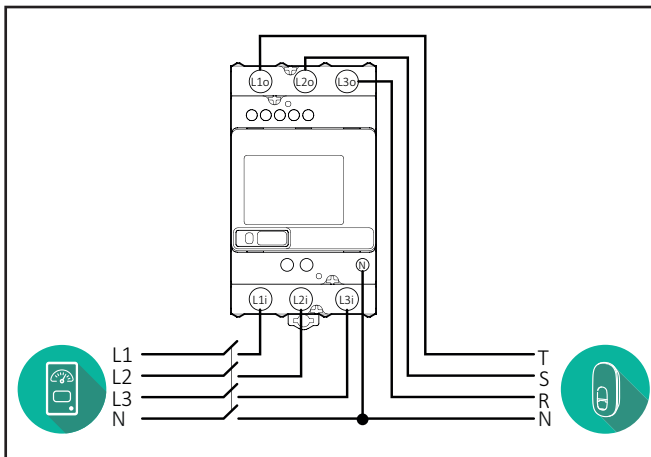

**Gavazzi, 1 phase, Direct, 100 A
(EM112DINAV01XS1PFB)**

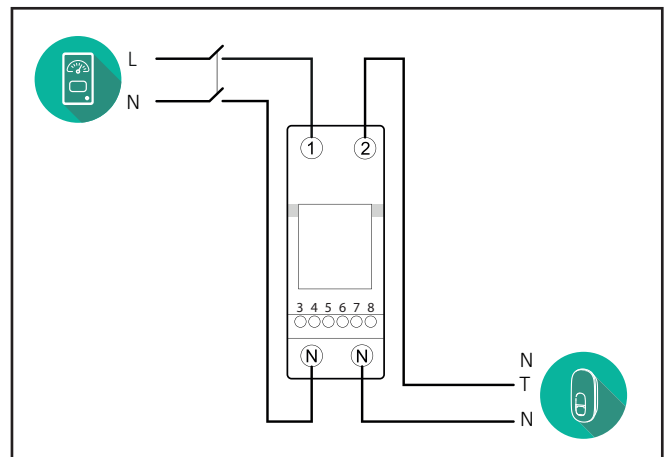

**Gavazzi, 1-phase, Direct, 32 A
(EM111DINAV81XS1PFB)**

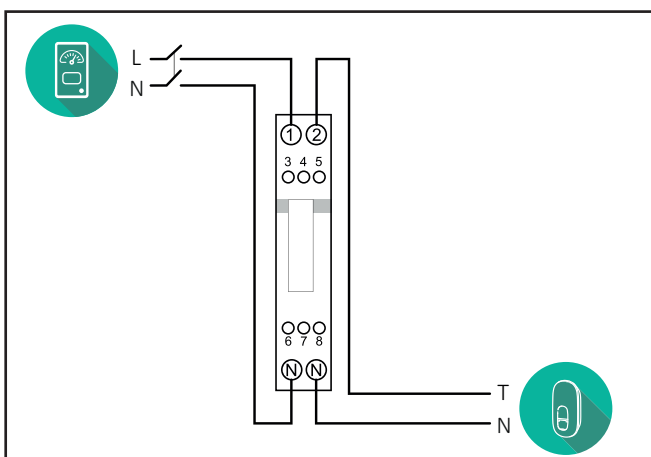

3.3. Communication cable installation

Install a communication cable between the **PowerMeter (DPM)** and the **eLuxWallbox**.

- On the **eLuxWallbox**, remove the protective cap of the communication cables entry point and insert the \varnothing 25 mm corrugated sheath.
- Tighten the box-cable sheath junction.
- Insert the communication cable, pulling it to a suitable length so that it reaches the communication port CN12, leaving some slack.
- Connect the Modbus RS485 communication cable to the GND, - and + pins of the CN12 connector.



NOTE: It is possible to replace the box-cable sheath junctions with \varnothing 25mm cable gland (not provided by the manufacturer).

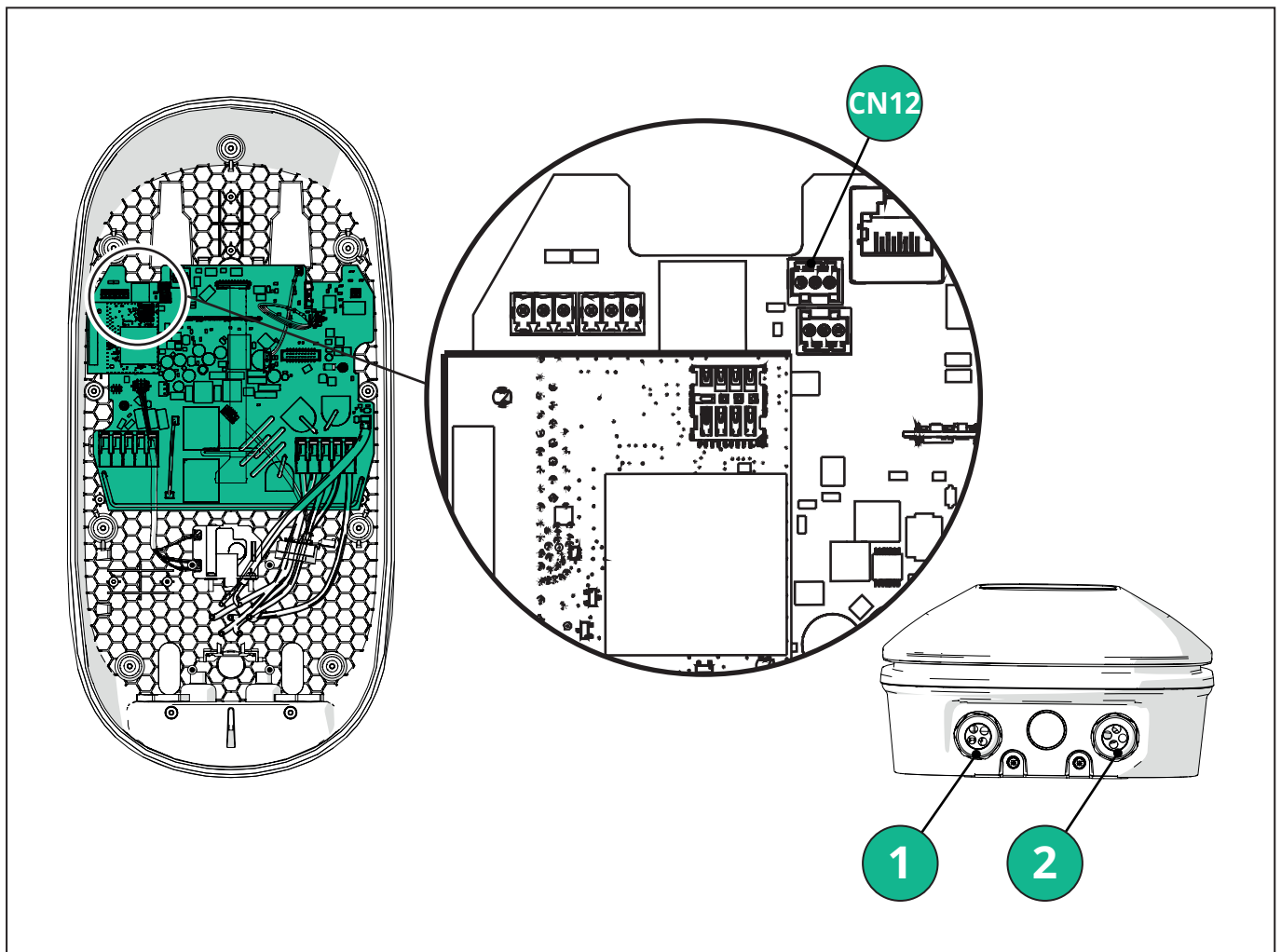

1 - Power supply cables

2 - Communication cables

CN12 - RS485 Modbus for external meter communication (**DPM** and **MID**)

Connect the communication cables in the following order from the **PowerMeter (DPM)** to **eLuxWallbox**.



WARNING: If the installation includes both accessories, follow the instructions for “MIDcounter and PowerMeter (DPM) combined installation”.

CN12	Finder 1ph 7M.24.8.230.0210
GND	SC
-	B
+	A

CN12	Gavazzi 3ph EM340DINAV23XS1PFB
GND	10
-	9
+	8

Junction 9/7

CN12	Finder 3ph 7M.38.8.400.0212
GND	SC
-	B
+	A

CN12	Gavazzi Ind 1ph EM111DINAV51XS1X / EM111DINMV51XS1X
GND	7
-	8
+	6

Junction 8/5

CN12	Gavazzi 1ph EM111DINAV81XS1PFB
GND	7
-	8
+	6

Junction 8/5

CN12	Gavazzi Ind 3ph EM330DINAV53HS1X
GND	13
-	12
+	11

Junction 12/10

3.4. MIDcounter and PowerMeter (DPM) combined installation

If installing both electrical accessories, the positioning of **MIDcounter** together with the **PowerMeter (DPM)** is indicated in the diagram below:

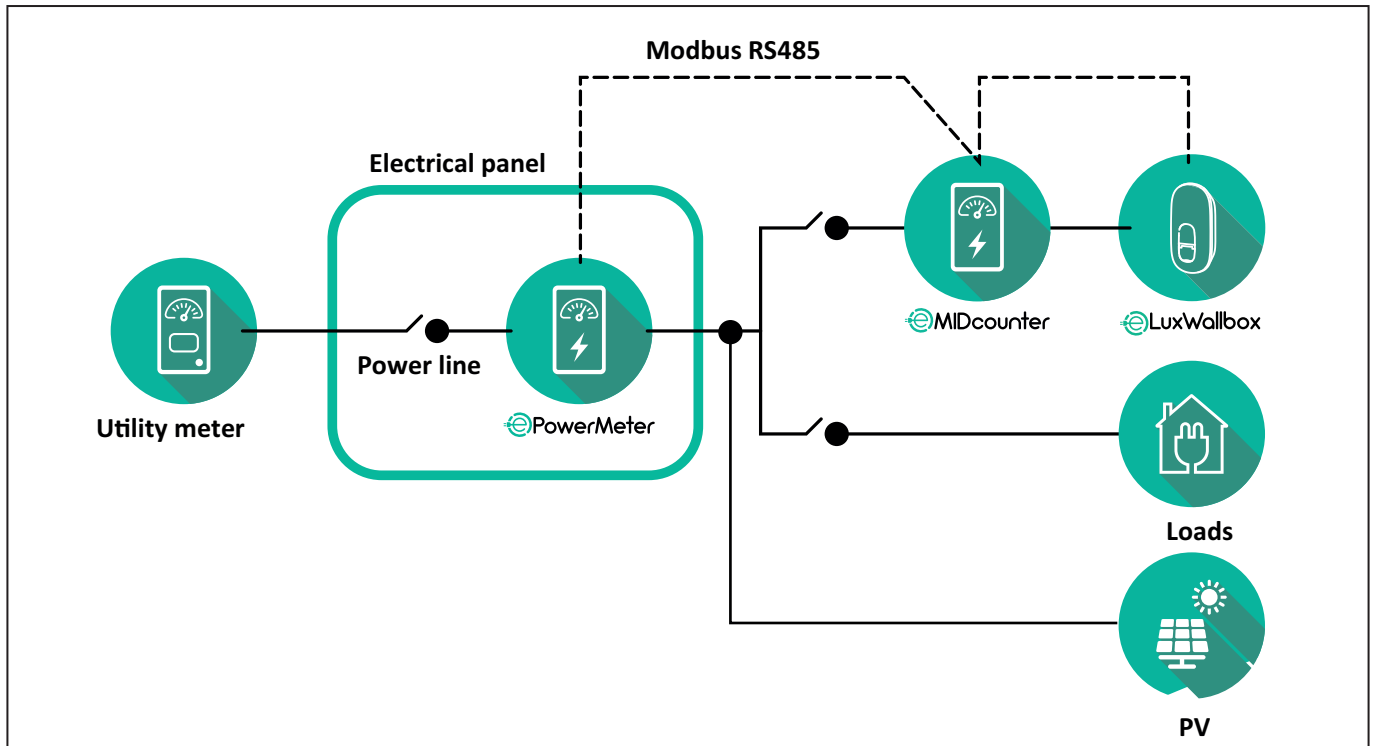

Connect the Modbus communication cables. The **PowerMeter (DPM)**, **MIDcounter** and the **eLuxWallbox** must be connected on the same communication bus in a Daisy chain format.

On the **eLuxWallbox**:

- Remove the protective cap of the communication cable entry point and insert the Ø 25 mm corrugated sheath.
- Tighten the box-cable sheath junction.
- Insert the communication cable, pulling it to a suitable length so that it reaches the communication port CN12, leaving some slack.
- Connect the Modbus RS485 communication cable to the GND, - and + pins of the CN12 connector.

Use the table below to connect the communication cables from the accessories to the **eLuxWallbox**.

Single-Phase.

PowerMeter (DPM)	MIDcounter	eLuxWallbox
EM111DINAV51XS1X - EM111DINMV51XS1X	EM111DINAV81XS1PFB	CN12
GND (7)	GND (7)	GND
A- (8) / T*(5)	A- (8)	-
B+ (6)	B+ (6)	+
EM111DINAV51XS1X - EM111DINMV51XS1X	7M 24.8.230.0210	CN12
GND (7)	SC	GND
A-(8) / T*(5)	B-	-
B+ (6)	A+	+
EM111DINAV81XS1PFB	EM111DINAV81XS1PFB	CN12
GND (7)	GND (7)	GND
A-(8) / T*(5)	A- (8)	-
B+ (6)	B+ (6)	+
EM111DINAV81XS1PFB	7M 24.8.230.0210	CN12
GND (7)	SC	GND
A-(8) / T*(5)	B-	-
B+ (6)	A+	+
7M 24.8.230.0210	EM111DINAV81XS1PFB	CN12
SC	GND (7)	GND
B-	A- (8)	-
A+	B+ (6)	+
7M 24.8.230.0210	7M 24.8.230.0210	CN12
SC	SC	GND
B-	B-	-
A+	A+	+

Three-Phase.

PowerMeter (DPM)	MIDcounter	eLuxWallbox
EM330DINAV53HS1X	EM340DINAV23XS1PFB	CN12
GND (13)	GND (10)	GND
A-(12) / T*(10)	A-(9)	-
B+ (11)	B+ (8)	+
EM330DINAV53HS1X	7M.38.8.400.0212	CN12
GND (13)	SC	GND
A-(12) / T*(10)	B-	-
B+ (11)	A+	+
EM340DINAV23XS1PFB	EM340DINAV23XS1PFB	CN12
GND (10)	GND (10)	GND
A-(9) / T*(7)	A-(9)	-
B+ (8)	B+ (8)	+
EM340DINAV23XS1PFB	7M.38.8.400.0212	CN12
GND (10)	SC	GND
A-(9) / T*(7)	B-	-
B+ (8)	A+	+
7M.38.8.400.0212	EM340DINAV23XS1PFB	CN12
SC	GND (10)	GND
B-	A-(9)	-
A+	B+ (8)	+
7M.38.8.400.0212	7M.38.8.400.0212	CN12
SC	SC	GND
B-	B-	-
A+	A+	+

*A 120 Ω terminating resistor must be installed on the devices at the ends of the Modbus chain. The resistor is present by default in the **eLuxWallbox**. Gavazzi models have a built-in resistor, which can be enabled by making a jumper between these terminals.

4. PowerMeter (DPM) and MIDcounter configuration

Power on the **PowerMeter (DPM)** and/or the **MIDcounter** when the electrical installation and communication installation are complete. Then proceed with the configuration on the display of the meters.

The configuration varies depending on the model.

4.1. Finder models

The following actions help to understand how to set Finder energy meters:

- Press the touchscreen button (a,b) to move between menus and parameters;
- Long press (~ 2 seconds) the touchscreen button (a,b) to enter and confirm selections

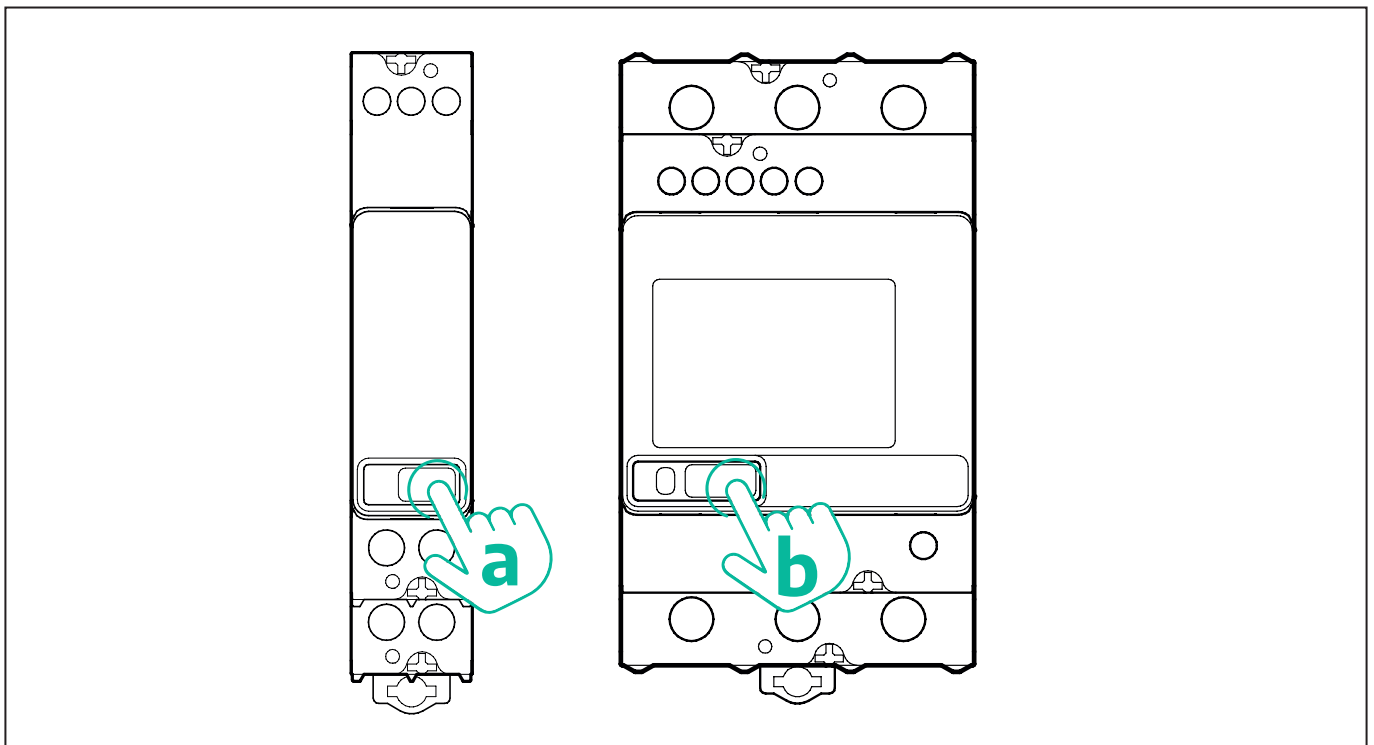

Follow the next steps to correctly configure the single-phase or three-phase Finder energy meters:

- When powering up the energy meter for the first time, long press the touchscreen button (a,b) until the display text blinks in order to enter the "MAIN" menu;
- Scroll the "MAIN" menu pressing the touchscreen button (a,b), then select "SETTING" ("SET" on single-phase meter). Long press to enter the selection.
- Scroll the "SETTING" menu pressing the touchscreen button (a,b), then select "COMMUNICATION" ("COMM" on single phase meter). Long press to enter the selection.
- Insert the correct values indicated in the table below. To modify the value press the touchscreen button (a,b), long press to confirm.

Only for three-phase Finder meter (in addition to previous options):

- Long press the touchscreen button (a,b) until the display text blinks in order to enter the "MAIN" menu (or return to the "MAIN" menu)
- Scroll the "MAIN" menu pressing the touchscreen button (a,b), then select "INSTALLATION". Long press the touchscreen button (a,b) to enter the selection
- Scroll the "INSTALLATION" menu pressing the touchscreen button (a,b) and then select the following option
 - "Communication mode" = "3L+N, L+N-Arithmetic"
 - Once the correct option is confirmed, enter the password: "DCBA" **Attention:** configuration cannot be modified after entering the password **DCBA**
 - Confirm the change selecting "Yes" when prompted.

ALL FINDER MODELS	PowerMeter (DPM)	MIDcounter
DEVICE ADDRESS	1	2
BITS PER SECOND (BAUD)	38400 bit/s	38400 bit/s
PARITY	Even	Even
STOP BIT	1	1
Additional for three-phase type		
	PowerMeter (DPM)	MIDcounter
COMMUNICATION MODE	3L+N, L+N-Arithmetic	3L+N, L+N-Arithmetic
PASSWORD	DCBA	DCBA

4.2. Gavazzi models

The following actions help to understand how to set Gavazzi energy meters:

- Press the touchscreen buttons (c, d, e, g) to move between menus and values
- press (~ 2 seconds) the touchscreen button (d, f) to enter the menu and confirm selections

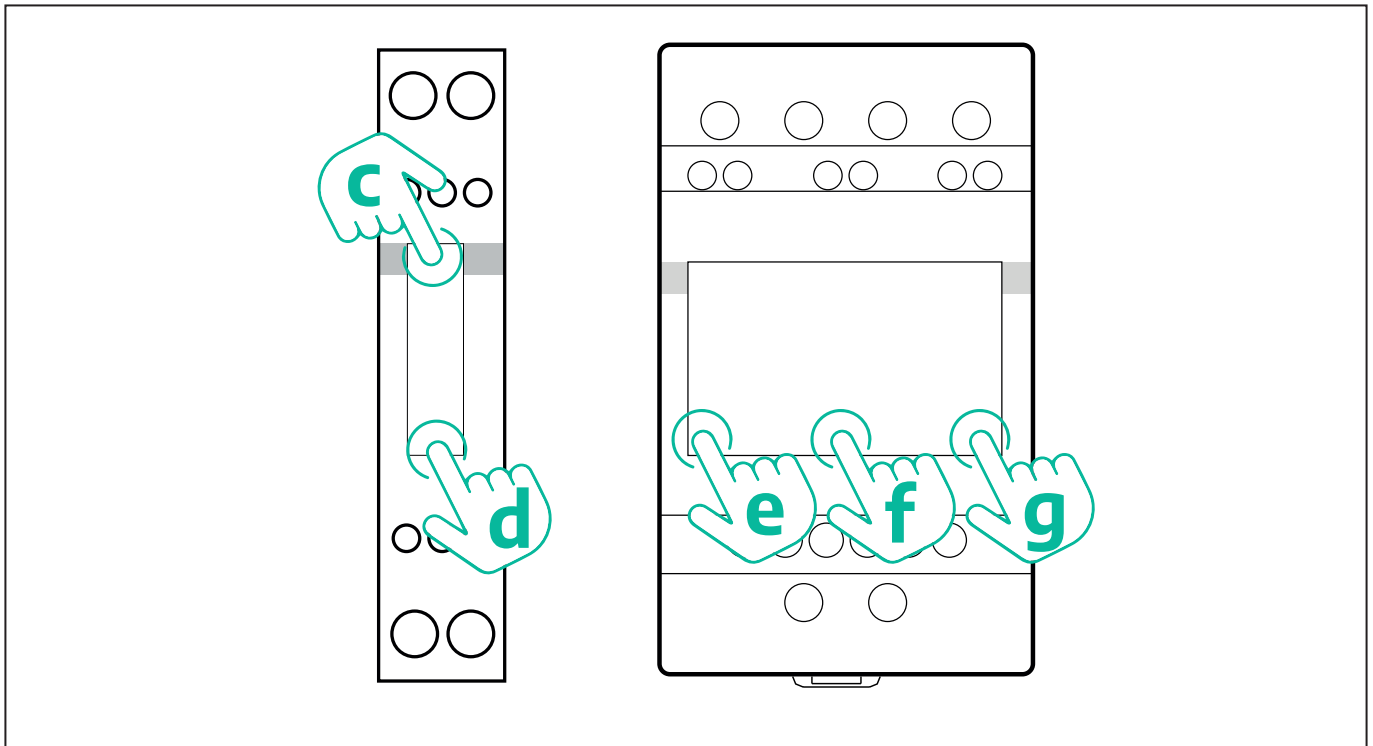

Follow the next steps to correctly configure the single-phase Gavazzi direct and indirect energy meters.

- When powering up the energy meter for the first time, long press the touchscreen button (d) until the password appears on the screen
- Long press the buttons (c, d) simultaneously in order to confirm the password "0000" and enter the "MAIN" menu
- Scroll the "MAIN" menu pressing the upper button (c) and then select the following options in the table below

Follow the next steps to correctly configure the three-phase Gavazzi direct and indirect energy meters:

- When powering up the energy meter for the first time, long press the central button (f) until the password appears on the screen;
- Long press the buttons (e, g) simultaneously in order to confirm the password "0000" and enter the "MAIN" menu
- Scroll the "MAIN" menu pressing the buttons (e or g) and then select the options in the table below

ALL GAVAZZI MODELS	PowerMeter (DPM)	MIDcounter
PASS	0000	0000
ADDRESS	001	002
BAUD	38.4	38.4
PARITY	Even	Even
Additional for three-phase type		
	PowerMeter (DPM)	MIDcounter
SYSTEM	3Pn	3Pn
ADDRESS	001	002

4.3. Device configuration summary

EM340DINAV23XS1PFB / EM330DINAV53HS1X		EM340DINAV23XS1PFB	
PASS	0000	PASS	0000
SYSTEM	3Pn	SYSTEM	3Pn
ADDRESS	1	ADDRESS	2
BAUD	38.4	BAUD	38.4
PARITY	EVEN	PARITY	EVEN

EM111DINAV81XS1PFB / EM111DINAV51XS1X / EM111DINMV51XS1X		EM111DINAV81XS1PFB	
PASS	0000	PASS	0000
ADDRESS	001	ADDRESS	002
BAUD	38.4	BAUD	38.4
PARITY	EVEN	PARITY	EVEN

7M 24.8.230.0210		7M 24.8.230.0210	
DEVICE ADDRESS	__ 1	DEVICE ADDRESS	__ 2
BITS PER SECOND (BAUD)	38400 bit/s	BITS PER SECOND (BAUD)	38400 bit/s
PARITY	EVEN	PARITY	EVEN
STOP BIT	1	STOP BIT	1

7M.38.8.400.0212		7M.38.8.400.0212	
DEVICE ADDRESS	__ 1	DEVICE ADDRESS	__ 2
BITS PER SECOND (BAUD)	38400 bit/s	BITS PER SECOND (BAUD)	38400 bit/s
PARITY	EVEN	PARITY	EVEN
STOP BIT	1	STOP BIT	1
CONNECTION MODE	3L+N, L+N - Arithmetic	CONNECTION MODE	3L+N, L+N - Arithmetic
PASSWORD	DCBA	PASSWORD	DCBA

4.4. PowerMeter (DPM) and MIDcounter configuration on APP

To complete installation, the final configuration of the **eLuxWallbox** and its accessories should be set via the dedicated app

PowerUp is a smartphone app for qualified installers only, available via Google Play™ and Apple Store®. The configuration is carried out via a Bluetooth connection. The wallbox cannot operate correctly if not configured via the app.



NOTICE: Make sure you have the latest version of PowerUp to have access to all of the features.

Follow the instructions below to get started with the app:

Download PowerUp to your smartphone and activate Bluetooth on the smartphone.



Scan **eLuxWallbox** QR code to pair it with the app. The QR Code can be found on the side of the charger.

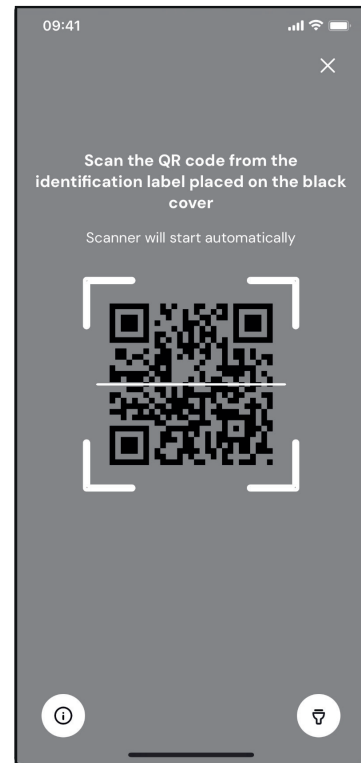

Once paired, complete the configuration set up of **eLuxWallbox** and its Accessories by clicking on the parameter to be configured.

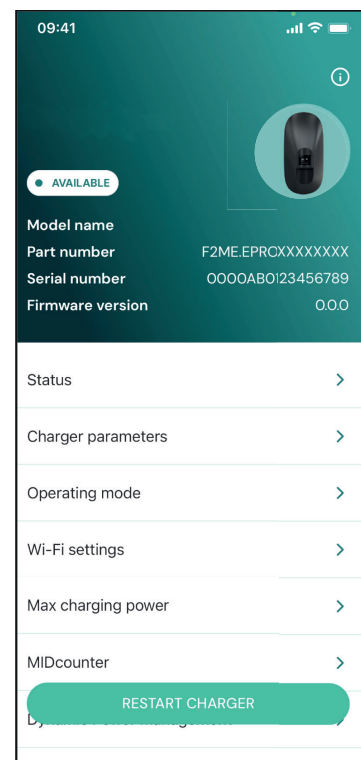

4.5. PowerMeter (DPM) configuration

To complete installation of the **PowerMeter (DPM)**, follow the steps below:

Select "**DPM PowerMeter**" on the homepage

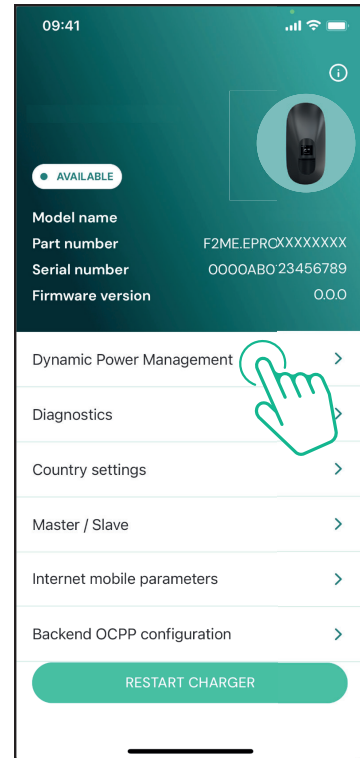

Select the **PowerMeter** type from the drop-down menu, matching the model installed.

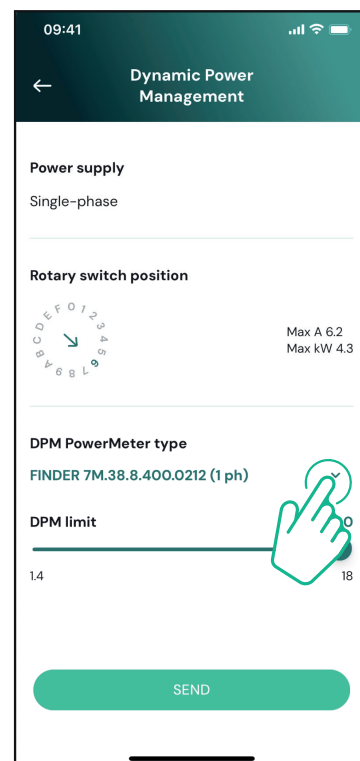

Enter the value of the user contractual power as **DPM** power limit.

For Indirect Meter only - Set the CT current ratio with the slider.

- With CTV 60 A set 60 as Current ratio
- With CTA 100 A set 20 as Current ratio
- With CTA 150 A set 30 as Current ratio

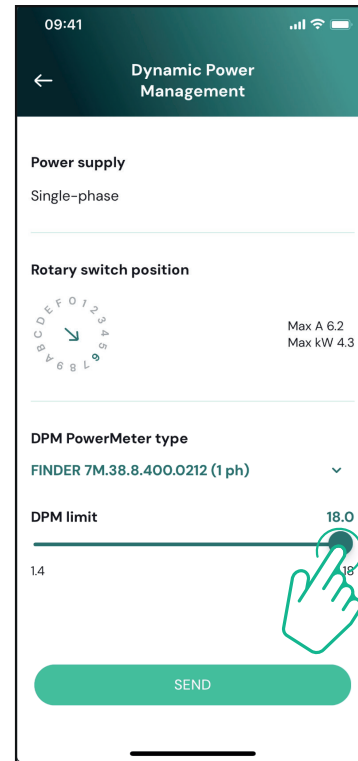

Click "Send" and confirm on the pop-up to restart **eLuxWallbox**.

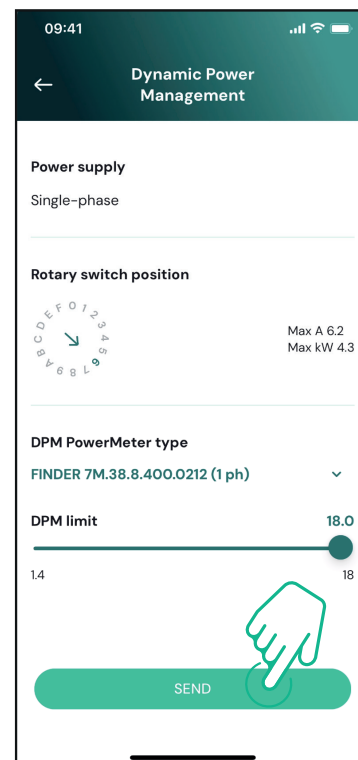

4.6. MIDcounter configuration

To complete installation of the **MIDcounter**, follow the steps below:

Select "**MIDcounter**" on the homepage

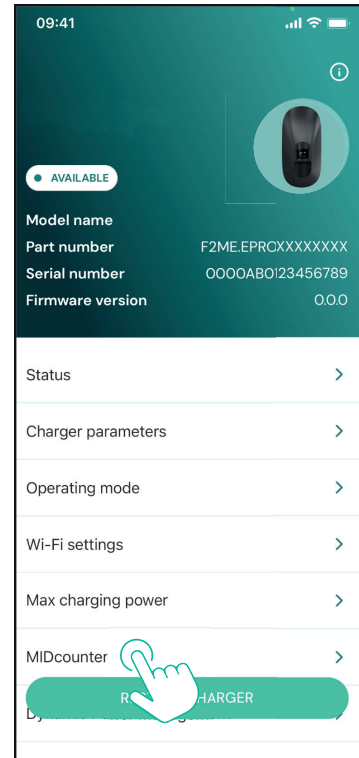

Select the **MIDcounter** type from the drop down menu, based on the model installed.

Select "OFF" from the drop down menu to disable the **MIDcounter** configuration.

Click "Send" to confirm.

To make the changes effective, click on the back arrow in the top left corner and restart **eLuxWallbox** through the dedicated button in the homepage.

If the installation has both the **PowerMeter (DPM)** and the **MIDcounter** it is possible to proceed with **DPM** configuration before restarting.

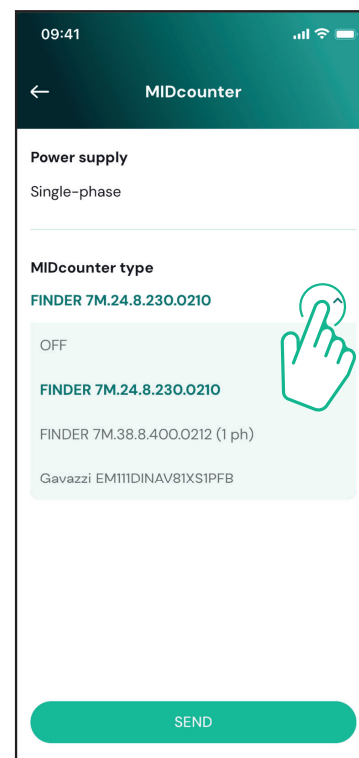

5. TROUBLESHOOTING

Error conditions are stored in the diagnostic logs and shown on the charger panel:

- On the **eLuxWallbox Move** model, the LED bar blinks red. See the **Diagnostic** section of PowerUP or the end-user App for the detailed error code.
- On the **eLuxWallbox** model, the display shows the error code, which is also available in the **Diagnostic** section of PowerUP.

When an error occurs, the charge is interrupted, and the socket is unlocked to allow you to disconnect the plug.

The following table provides a list of errors that can occur and the relative troubleshooting. If the error persists, note the serial number on the charger label and contact Customer Service.

Error code / issue	"Error Description"	Troubleshooting
100	Lack of power supply	<p>Check if the circuit breaker is ON. Check that the CN1 cabling is correct. Check the voltage in CN1.</p>
101	Overheating	<p>Disconnect the Type 2 cable, wait for the temperature to drop, then the error will clear.</p> <p>To restart the charging session, plug in the cable again. Make sure that installation site is compatible with temperature range (25°C/+50°C without direct exposure to sunlight)</p>
102	Communication error between MCU and MPU.	<p>Restart the charger from the circuit breaker, leaving the charger switched off for at least 60 seconds.</p>
103	Hardware fault, ground protection device error (GPD error)	<p>Check the cabling on CN1:</p> <ul style="list-style-type: none"> - in single-phase, make sure that ground cable is connected to PE, the Neutral cable is connected to N and the phase cable to T - in three-phase, make sure that the ground cable is connected to PE, the Neutral cable is connected to N and the phase cables L1, L2 and L3 are connected to T, S, and R. <p>Check whether the voltage difference between PE and N does not exceed 10V. Check PE connection</p> <p>If all connections are checked and the error persists, open the charger and modify the configuration of the Dipswitch (SW2) connector.</p>

104	Hardware fault, residual current monitor AC error. (RCM AC trip)	<p>Try to start a new charging session, removing and plugging in all the connectors.</p> <p>If the problem persists, check for the presence of any problems in the charging cable or vehicle inlet.</p> <p>If the cables and the EV don't show any problem, check CN27 connector and RCM cable.</p>
105	Hardware fault, residual current monitor DC error. (RCM DC trip)	<p>Check that the problem is not with the cable or vehicle. If possible, try another charging session with a different cable or vehicle.</p>
106	Internal meter error	<p>Restart the charger from the circuit breaker, leaving the charger switched off for at least 60 seconds.</p>
107	PowerMeter (DPM) communication error	<p>Check that the communication configuration on the DPM PowerMeter device is correct.</p> <p>Check that the DPM model configuration in the installer App is correct.</p> <p>Check the communication cable wiring on CN12.</p> <p>Check that the communication cable used is suitable for Modbus RS485 and cable length.</p>
108	Configuration Error, Rotary switch position (supply type) is not consistent with the DPM/ MID type.	<p>Check the position of the rotary switch. If it is not consistent with the 1-ph/3-ph installation, change it according to the table in the manual, then restart the charger.</p> <p>If the accessories (DPM/MID) are not installed, make sure that the function is disabled in the installer App.</p> <p>If the accessories (DPM/MID) are installed, check that the correct model is selected on the installer App. Then restart the charger.</p>
109	Main/secondary RS485 communication error	<p>Check the configuration of the Main/Secondary set up from installer App.</p> <p>Check that the Main charger is available.</p> <p>Check that the wiring of the communication cable on CN9 and CN10 is correct.</p> <p>Check that the communication cable used is suitable for Modbus RS485.</p>

110	MIDcounter communication error	<p>Check that the communication configuration on the MIDcounter device is correct.</p> <p>Check the communication cable wiring on CN12.</p> <p>Check that the communication cable used is suitable for Modbus RS485.</p> <p>Check that the MID model configuration in the installer App is correct.</p>
300	Inconsistency between the charger contactor command and feedback	<p>Restart the charger from the circuit breaker, leaving the charger switched off for at least 60 seconds.</p> <p>If error persists even after restart, call Customer Service.</p>
301	Short circuit detected on the Control Pilot line.	<p>With the charger switched off, check that there is no damage and no defects inside and outside the socket (if so, avoid using the charger and contact Customer Service).</p> <p>Check that the problem is not related to the cable or vehicle and try another charge session (with another vehicle or cable if possible).</p>
302	State E or F set on the Control Pilot line.	<p>With the charger switched off, check that there is no damage and no defects inside and outside the cable and its connectors (if so, avoid using it and attempt charge with another cable).</p>
303	Control Pilot disconnected.	<p>Check that the cable connectors are fully inserted inside the charger socket and vehicle inlet.</p>
304	Proximity Pilot disconnected.	<p>Check that the problem is not related to the cable or vehicle and try another charge session (with another vehicle or cable if possible).</p>
305	Broken Proximity Pilot detected.	<p>Check that the problem is not related to the cable or vehicle and try another charge session (with another vehicle or cable if possible).</p>
306	Diode fault detected on Control Pilot line (no - 12V).	<p>Attempt a new charging session unplugging and reinserting the cable from both the charger and vehicle inlet.</p>
307	Control Pilot disconnected.	<p>With the charger switched off, check that there is no damage and no defects inside and outside the cable and its connectors (if so, avoid using it and attempt charge with another cable).</p> <p>Check that the cable connectors are fully inserted inside the charger socket and vehicle inlet.</p> <p>Check that the problem is not related to the cable or vehicle and try another charge session (with another vehicle or cable if possible).</p>

308	Inconsistency between the motor command and feedback, or the motor is in an error condition.	<p>Attempt a new charging session unplugging and reinserting the cable from both the charger and vehicle inlet.</p> <p>Check that the cable connectors are fully inserted inside the charger socket and vehicle inlet.</p>
309	Motor check error during EVSE initialization phase.	Restart the charger from the circuit breaker, leaving the charger switched off for at least 60 seconds.
310	Error detected before charging (PP not detected, or motor fault, or CP not detected).	<p>With the charger switched off, check that there is no damage and no defects inside and outside the cable and its connectors (if so, avoid using it and attempt charge with another cable).</p> <p>Check that the cable connectors are fully inserted inside the charger socket and vehicle inlet.</p>
311	Error detected after charging (motor fault, or CP not disconnected).	Check that the problem is not related to the cable or vehicle and try another charge session (with another vehicle or cable if possible).
312	Emergency stop received from the MPU.	Restart the charger from the circuit breaker, leaving the charger switched off for at least 60 seconds.
313	Current detected during charging, with 100% duty cycle on the Control Pilot line.	Check that the problem is not cable nor vehicle related, attempt a new charging session with another cable and/or charger.
315	Current over limits on phase L1	Unplug the cable, if possible lower the power of charge on the vehicle side and attempt a new charging session.
316	Current over limits on phase L2	
317	Current over limits on phase L3	
318	Voltage below a threshold on phase L1	<p>Check the rotary switch position is consistent with 1-ph/3-ph installation.</p> <p>Check that the voltage on CN1-T is above 196 V.</p> <p>If the voltage is below 196 V, check the electric system or contact the energy supplier.</p> <p>If an error occurs during vehicle charging, try to reduce the set-up charging power and verify that the electric system is correctly dimensioned for the power drawn by the vehicle.</p>

319	Voltage below a threshold on phase L2	The rotary switch is in a three-phase position. Check that the intended installation is in three-phase. If not, select the correct rotary switch position as per Installation Manual.
320	Voltage below a threshold on phase L3	<p>Check that the voltage on CN1-S and R is above 196 V. If the voltage is below 196V, check the electric system or contact the energy supplier.</p> <p>If an error occurs during vehicle charging, try to reduce the set-up charging power and verify that the electric system is correctly dimensioned for the power drawn by the vehicle.</p>
321	Forbidden state change (IEC 61851-1)	<p>EV does not meet IEC 61851-1 standards for starting a charge session.</p> <p>Attempt a new charging session unplugging and reinserting the cable from both the charger and vehicle inlet.</p> <p>If the error persists, contact the vehicle manufacturer.</p>
	Display/LED stuck in Welcome mode (LED blinks red-green-blue)	Restart the charger from the circuit breaker, leaving the charger switched off for at least 60 seconds.
	LED or display does not light up at startup	
	The charger does not start	<p>Let the unit restart, it may take up to 30 seconds.</p> <p>Check if the circuit breaker is ON.</p> <p>Check that the CN1 cabling is correct.</p> <p>Check the voltage in CN1.</p> <p>Restart the charger from the circuit breaker, leaving the charger switched off for at least 60 seconds.</p>
	Cable stuck in the charger socket	Turn off the charger from the circuit breaker, then remove the cable.
	Suspended Charging with solid green LED/ message on the display. The charging session is suspended by the DPM or the EV. The session may resume.	<p>Verify that the max power in the DPM power limit section of the installer App is consistent with the contract power value in kW as indicated in the user's electricity contract. If the value is correct, wait for the charging session to resume or turn off some house loads.</p> <p>In the case of 3-ph installation, verify that the electrical loads are well balanced on the phases of the domestic system.</p>

	<p>App pairing does not complete after QR scan.</p>	<p>Check the integrity of the QR code on the label. Update the App to the latest version. Close and restart the App, then try again. Restart the charger from the circuit breaker, leaving the charger switched off for at least 60 seconds.</p>
--	---	---

6. CLEANING

Cleaning the outside of the device is always recommended when necessary and should be carried out using a soft damp cloth with a mild detergent. When finished, wipe off any traces of moisture or liquid with a soft dry cloth.



CAUTION: Avoid strong jets of air or water as well as the use of soaps or detergents that are too harsh and corrosive for the materials of the charger.

7. PACKAGING DISPOSAL



Dispose of packaging in an environmentally friendly manner. The materials used for packaging this product can be recycled and must be disposed of in compliance with the legislation in force in the country of use. The following disposal directions will be found on the packaging based on the type of material.



NOTE: Further information about current disposal facilities can be obtained from local authorities.

8. ASSISTANCE

If you have any questions about the installation of **eLuxWallbox**. For any other information or requests for support, please contact Free2move eSolutions S.p.A. through the relevant section of its website: www.esolutions.free2move.com.

9. DISCLAIMER

Free2move eSolutions S.p.A. will not be held responsible for any damage directly or indirectly caused to people, things or animals due to the failure to comply with all the provisions set out in this Manual, and the warnings regarding the installation and maintenance of **eLuxWallbox**.

Free2move eSolutions S.p.A. reserves all rights to this document, the article and the illustrations it contains. The reproduction, whole or in part, disclosure to third parties or use of its contents is prohibited without the prior written consent of Free2move eSolutions S.p.A.

Any information in this manual may be changed without prior notice and does not represent any obligation on the part of the manufacturer. Images in this manual are for illustrative purposes only and might differ from the delivered product.

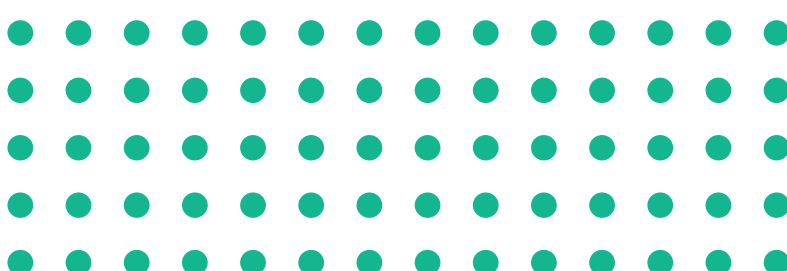

Registered office
Free2move eSolutions S.p.A.
Piazzale Lodi, 3
20137 Milan - Italy
www.esolutions.free2move.com

EN

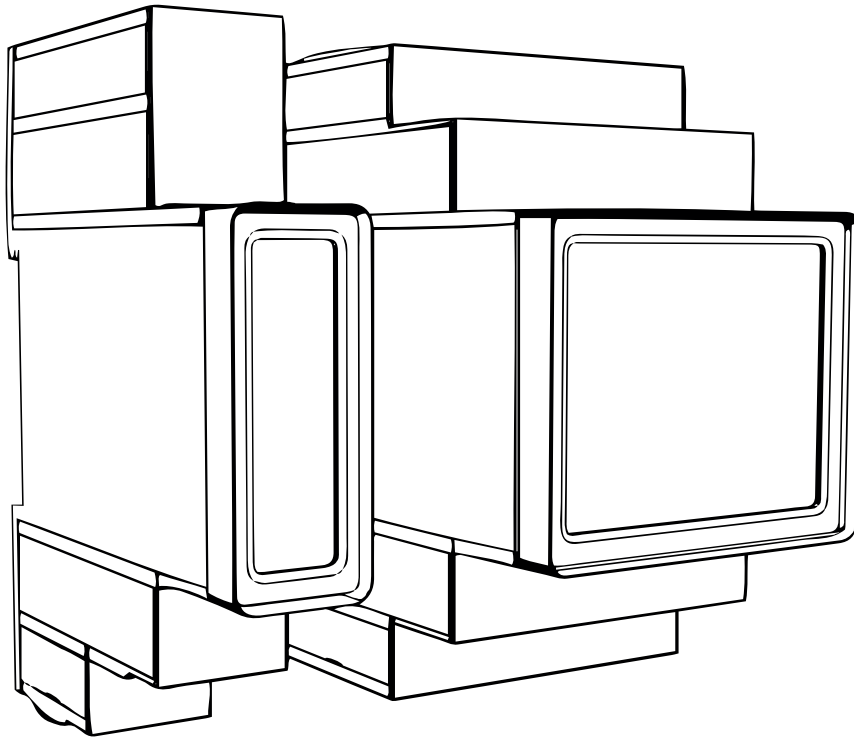
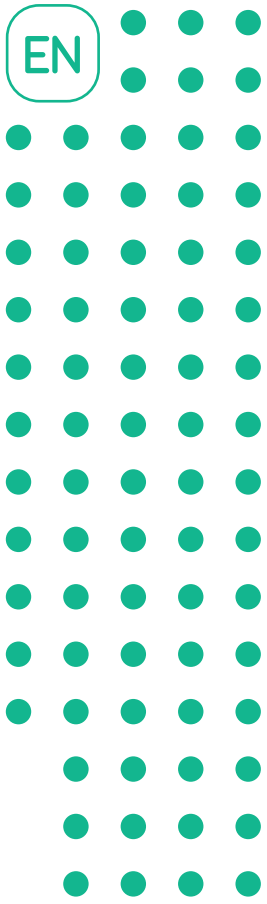

LuxWallbox

Accessories Manual



For safe and proper use,
follow these instructions.
Keep them for future reference

Table of content

1. INTRODUCTION	4
1.1. Purpose of the Manual	4
1.2. Identification of the Manufacturer.....	4
1.3. Structure of the Accessories Manual	4
1.4. Safety	5
1.5. Personal Protective Equipment (PPE).....	6
1.6. Warranty and delivery conditions	6
1.7. List of documents.....	7
1.8. Warnings	7
2. GENERAL INFORMATION	8
2.1. Fields of use	9
3. ACCESSORIES INSTALLATION	10
3.1. Installing PowerMeter (DPM).....	10
3.2. Installing MIDcounter	15
3.3. Communication cable installation	17
3.4. MIDcounter and PowerMeter (DPM) combined installation .	19
4. PowerMeter (DPM) and MIDcounter configuration.	22
4.1. Finder models.....	22
4.2. Gavazzi models.....	24
4.3. Device configuration summary	25
4.4. PowerMeter (DPM) and MIDcounter configuration on APP ..	26
4.5. PowerMeter (DPM) configuration	28
4.6. MIDcounter configuration.....	30
5. TROUBLESHOOTING.....	31
6. CLEANING.....	36
7. PACKAGING DISPOSAL	36
8. ASSISTANCE.....	37
9. DISCLAIMER.....	37



1. INTRODUCTION

1.1. Purpose of the Manual

This installation manual is a guide to help operators to work safely and carry out the installation operations needed to keep the charger in good working order.

The purpose of this document is to support qualified technicians who have received appropriate training, and demonstrated suitable skills and knowledge in the construction, installation, operation and maintenance of electrical equipment.

If the charger is used in a manner not specified in this manual, the protection provided by the charger may be impaired. This document contains the information required for the installation of the charger.

This document has been carefully checked by the Manufacturer Free2move eSolutions S.p.A. but oversights cannot be completely ruled out. If any errors are noted, please inform Free2move eSolutions S.p.A. Except for explicit contractual obligations, under no circumstances may Free2move eSolutions S.p.A. be held liable for any loss or damage resulting from the use of this manual, or from installation of the equipment. This document was originally written in English. In the event of any inconsistencies or doubts, please ask Free2move eSolutions S.p.A. for the original document.

1.2. Identification of the Manufacturer

The manufacturer of the charger is:

Free2move eSolutions S.p.A.

Piazzale Lodi, 3

20137 Milan – Italy

www.esolutions.free2move.com

1.3. Structure of the Accessories Manual





This manual is divided into chapters based on different topics and containing all the information that is needed to install the charger safely.

Each chapter is sub-divided into paragraphs which examine the fundamental points, and each paragraph may have its own title, along with sub-titles and a description.

1.4. Safety

This manual contains important safety instructions that must be followed during installation of the charger.

In order to fulfil this objective, this manual contains a number of precautionary texts, containing special instructions. These instructions are highlighted by a specific text box and are accompanied by a symbol, and are provided in order to ensure the safety of the personnel required to perform the operations described, and to avoid any damage to the charger and/or property:

	<p>This symbol means: DANGER</p> <p>This symbol is intended to highlight a dangerous situation for yourself and others. Read it carefully. Failure to comply with the instruction will result in an imminent hazardous situation which, if not avoided, will result in instant death, or serious or permanent injury.</p>
	<p>This symbol means: WARNING</p> <p>This symbol is intended to highlight safety information. Failure to comply with the instruction will result in a potentially hazardous situation which, if not avoided, could result in death or serious injury.</p>
	<p>This symbol means: CAUTION</p> <p>This symbol is intended to highlight safety information. Read it carefully. Failure to follow these instructions can result in death, serious injury or damage to equipment.</p>
	<p>This symbol means: NOTE</p> <p>Provides additional information to supplement instructions provided.</p>
	<p>This symbol means: NOTICE</p> <p>Provides instructions concerning the use of conduct necessary to handle the operations not associated with possible physical injuries.</p>

Installation must be carried out by qualified personnel. A dedicated, state-of-the-art electricity supply system must be designed and installed, and the system must be certified in compliance with local regulations and the energy supply contract.

Operators are required to read and fully understand this manual, and to comply strictly with the instructions it contains.

Free2move eSolutions S.p.A. cannot be held liable for damage caused to persons and/ or property, or to the equipment, if the conditions described in this document have not been complied with.





WARNING: Installation must be carried out in accordance with the regulations in force in the country of installation, and in compliance with all safety regulations for carrying out electrical work.

1.5. Personal Protective Equipment (PPE)

Personal Protective Equipment (PPE) means any equipment intended to be worn by the workers in order to protect them against one or more hazards likely to threaten their health or safety at the workplace, as well as any device or accessory intended for this purpose.

Since all the PPE indicated in this manual is intended to protect the personnel against health and safety hazards, the Manufacturer of the charger which is the subject of this manual recommends strict compliance with the indications contained in the various sections of this manual.

The list of PPE to be used in order to protect the operators against the residual risks present during the installation and maintenance interventions described in this document is provided below.

Symbol	Meaning
	Wear protective gloves
	Wear anti-static footwear



WARNING: It is responsibility of the operator to read and understand local regulations and evaluate the environmental conditions of the installation site in order to comply the need to wear additional PPE.

1.6. Warranty and delivery conditions

The warranty details are described in the Terms and Conditions of Sale included with the purchase order for this product and/or in the packaging of the product.

Free2move eSolutions S.p.A. assumes no responsibility for failure to comply with the instructions for proper installation, and cannot be held responsible for systems upstream or downstream of the equipment supplied.

Free2move eSolutions S.p.A. cannot be held responsible for defects or malfunctions deriving from: improper use of the charger; deterioration due to transport or particular environmental conditions or installation by unqualified persons.

Free2move eSolutions S.p.A. is not responsible for any disposal of the equipment, or parts thereof, that does not comply with the regulations and laws in force in the country of installation.



NOTICE: Any modification, manipulation or alteration of the hardware or software not expressly agreed with the manufacturer will immediately void the warranty.

1.7. List of documents

In addition to this manual, product documentation can be viewed and downloaded by visiting: www.esolutions.free2move.com.

1.8. Warnings



DANGER: Risk of electric shock and fire. Installation must be carried out in accordance with the regulations in force in the country of installation, and in compliance with all safety regulations for carrying out electrical work.

- Before installing or using the device, make sure that none of the components have been damaged. Damaged components can lead to electrocution, short circuits, and fire due to overheating. A device with damage or defects must not be used.
- Install **eLuxWallbox** away from petrol cans or combustible substances in general.
- Before installing **eLuxWallbox compatible accessories**, ensure the main power source has been disconnected.
- The **eLuxWallbox compatible accessories** must only be used for the specific applications they are designed for.
- Installation not carried out correctly may pose risks to the user.
- The charger must be connected to a mains network in compliance with local and international standards, and all the technical requirements indicated in this manual.
- Children or other persons not able to gauge risks related to the installation of the charger could suffer serious injury or put their lives at risk.
- Pets or other animals must be kept away from the device and packaging material
- Children must not play with the device, accessories or packaging provided with the product.
- The only part that can be removed from **eLuxWallbox**, is the removable cover. Access under the cover is only permitted by qualified personnel during installation, dismantling or maintenance.
- **eLuxWallbox** can only be used with an energy source.
- Necessary precautions to ensure safe operation with Active Implantable Medical Devices must be taken. To determine whether the charging process could adversely affect the medical device, please contact its manufacturer.

2. GENERAL INFORMATION

eLuxWallbox is an Alternate Current charging solution for powering electric vehicles and hybrid plug-ins, and is ideal for semi-public and residential use. The charger is available in three-phase or single-phase configurations and is equipped with a Type 2 socket.

The charger charges electric vehicles up to 22 kW in three-phase, or up to 7.4 kW in single-phase. The charger includes connectivity options such as remote monitoring via the eSolutions control platform (CPMS). Its final configuration must be completed using the **PowerUp** application. For the end user, the **eLuxWallbox** can be managed via the dedicated user's eSolutions Charging App. Both applications are available on Google Play™ and Apple Store®.

This charger is equipped with a SIM card for connection to the 4G mobile network.

The SIM card is automatically activated the first time the charger is turned on.

This document describes how to install the external accessories compatible with the **eLuxWallbox**.

The external accessories described in this manual are:

- **PowerMeter (DPM)**: an energy meter that enables the Dynamic Power Management (**DPM**) which is a smart function that allows an electric vehicle to be recharged using only the power available at home, modulating the charging power and avoiding unpleasant blackouts.
- **MIDcounter**: a certified energy meter that allows to monitor the consumption of the **eLuxWallbox** during each charging session.

This manual contains a description of the characteristics of the different accessories, information on models, installation process and final configuration of the devices.

The **eLuxWallbox** is configured to be used with the following electrical accessories: **PowerMeter (DPM)** or **MIDcounter**:

- Gavazzi, 1-phase, Direct, 32 A
- Finder, 1-phase, Direct, 40 A
- Gavazzi, 3-phase, Direct, 65 A
- Finder, 3-phase, Direct, 80 A

PowerMeter (DPM):

- Gavazzi, 1-phase, Indirect with 1x CT 100 A
- Gavazzi, 1-phase, Indirect with 1x CTV 60 A
- Gavazzi, 3-phase, Indirect with 3x CT 150 A



WARNING: Do not try to install the Electrical Accessories if you are not qualified as a professional electrician. To do so could cause serious danger and harm to you and to the people, property or animals around you.

To complete the installation, it is necessary to configure the **eLuxWallbox** through the dedicated apps:

	Installer's app: PowerUp
Product versions (EU):	EPRO23S224GWBAX
Product versions (UK):	EPRO23S224GWBAS



WARNING: Only Electrical Accessories suggested by Free2move eSolutions S.p.A. are compatible. Installation must be performed by qualified personnel in accordance with local regulations.

2.1. Fields of use

Free2move eSolutions S.p.A. declines all liability for any damage whatsoever due to incorrect or careless actions.

The charger may not be used for any purpose other than the one it is intended to fulfill.

The equipment must not be used by children or people with limited mental or physical abilities, or even by adults or expert professionals if the charger undergoes operations that do not comply with this manual and accompanying documentation.

The charger is a charging device for electric vehicles; the following classification (according to IEC 61851-1) identifies its characteristics:

- Power supply: permanently connected to the AC power supply grid
- Output: Alternate Current
- Environmental conditions: indoor / outdoor use
- Fixed installation
- Protection against electric shock: Class I
- EMC Environment classification: Class B
- Charging type: Mode 3 according to the IEC 61851-1 standard
- Optional function for ventilation not supported

3. ACCESSORIES INSTALLATION

To install the electrical accessories, it is necessary to use Modbus communication cables with the following characteristics:

- Modbus RS485 twisted STP 2x2 AWG24 or S/FTP cat.7 suitable for installation with a 400V power line
- Conductor size: 0.5 mm²
- Stripping length: 10 mm
- Recommended maximum length: 150 m

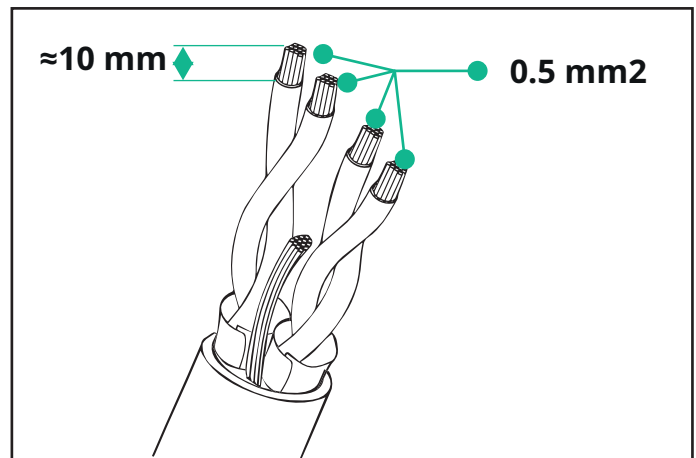

3.1. Installing PowerMeter (DPM)

PowerMeter (DPM) is an energy meter that enables the Dynamic Power Management (**DPM**) which is a smart function that allows an electric vehicle to be recharged using only the power available at home, modulating the charging power and avoiding unpleasant blackouts. Whenever other appliances are being used during the charging session, the system can modulate the charging power towards the car, even temporarily suspending the charging session. As soon as the other domestic appliances are switched off, the session will resume.

The **DPM** smart logic works both in three-phase and in single-phase installations.



WARNING: When installing in three-phase systems, make sure that the electrical loads (including the wallbox) are well balanced between the phases of the electrical system.



WARNING: Before carrying out any installation or maintenance work on the device, it must be ensured that the power supply is switched off.

For Direct models of the PowerMeter (DPM):

Place the **PowerMeter (DPM)** after the main utility meter. The **PowerMeter (DPM)** must measure all the electrical loads, including the **eLuxWallbox**.

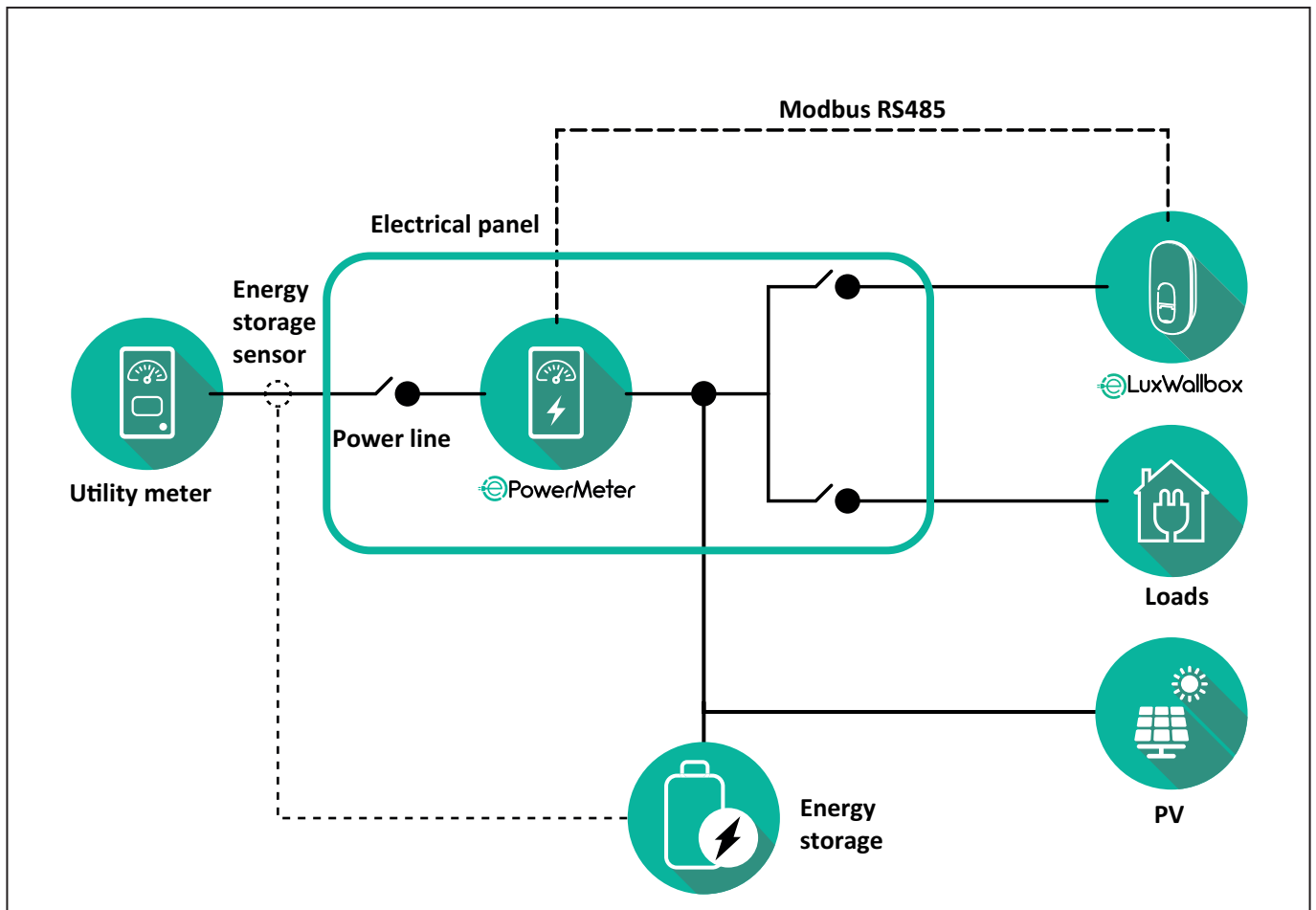

For Direct models of the PowerMeter:



WARNING: During the installation always refer to the manufacturer installation manual provided with the meter.



NOTE: For the single-phase or three-phase electrical connection of the Direct **PowerMeter**, please refer to the diagrams below.

Finder model 1ph and 3ph

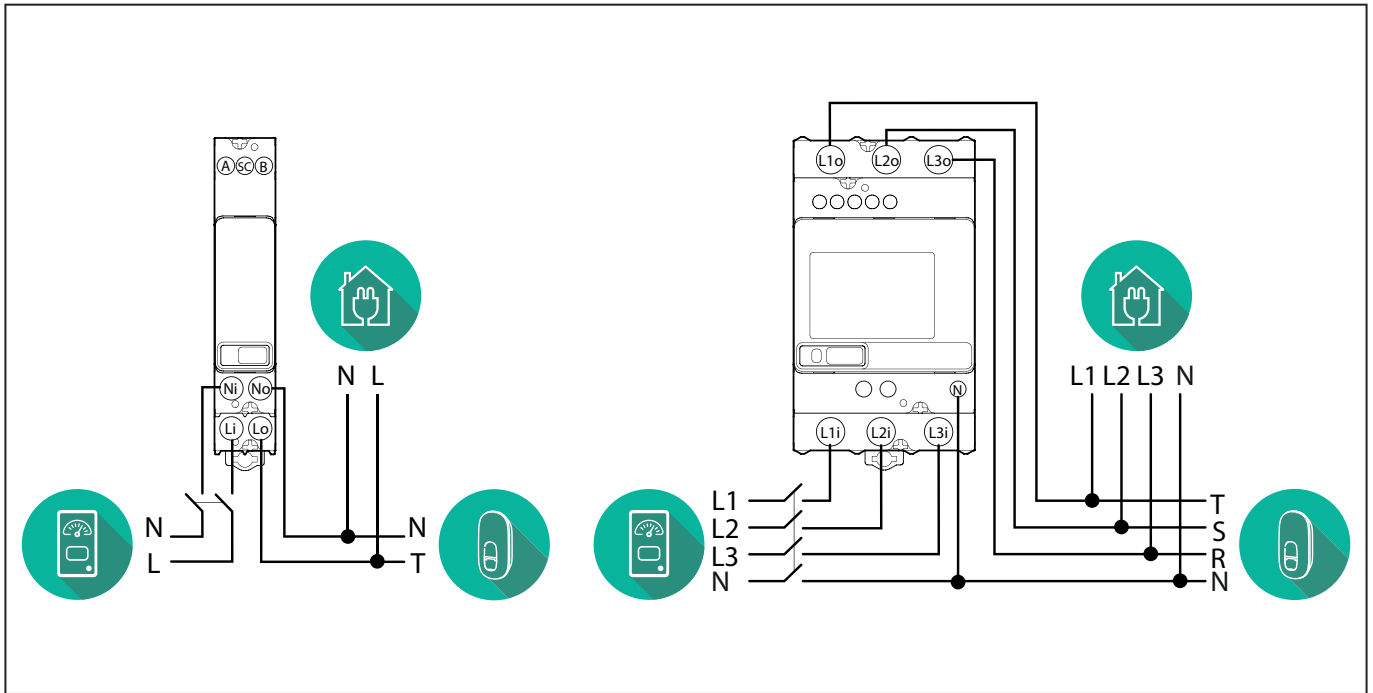

Gavazzi model 1ph and 3ph

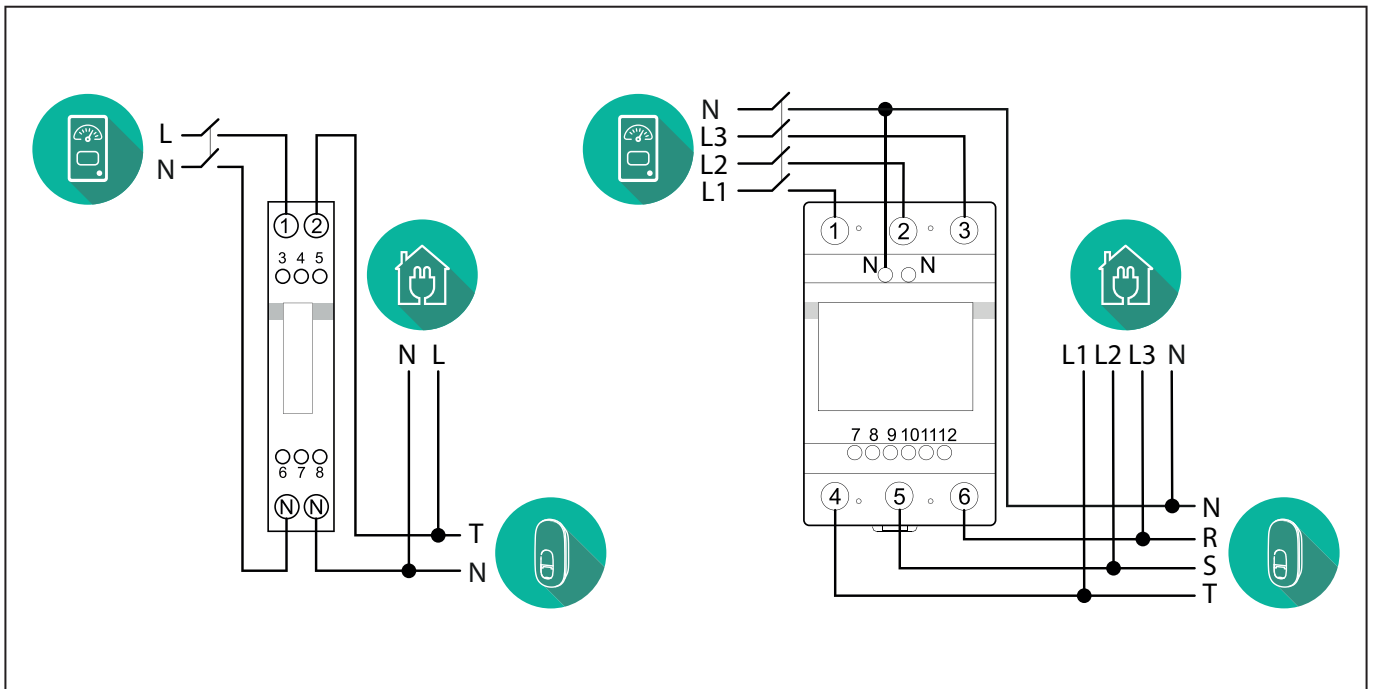

NOTICE:



- 1) If PV is present, the **PowerMeter** should be placed between the Utility Meter and the PV connection point.
- 2) If there is a home Energy storage, the **PowerMeter** should be placed between the Energy storage connection point and the Energy storage measurement sensor.

For Indirect models of the PowerMeter:

Place the CT (current transformer) of the **PowerMeter** after the main utility meter and before the main switch of the house/building. The current transformer must measure all the domestic loads, including the **eLuxWallbox**.

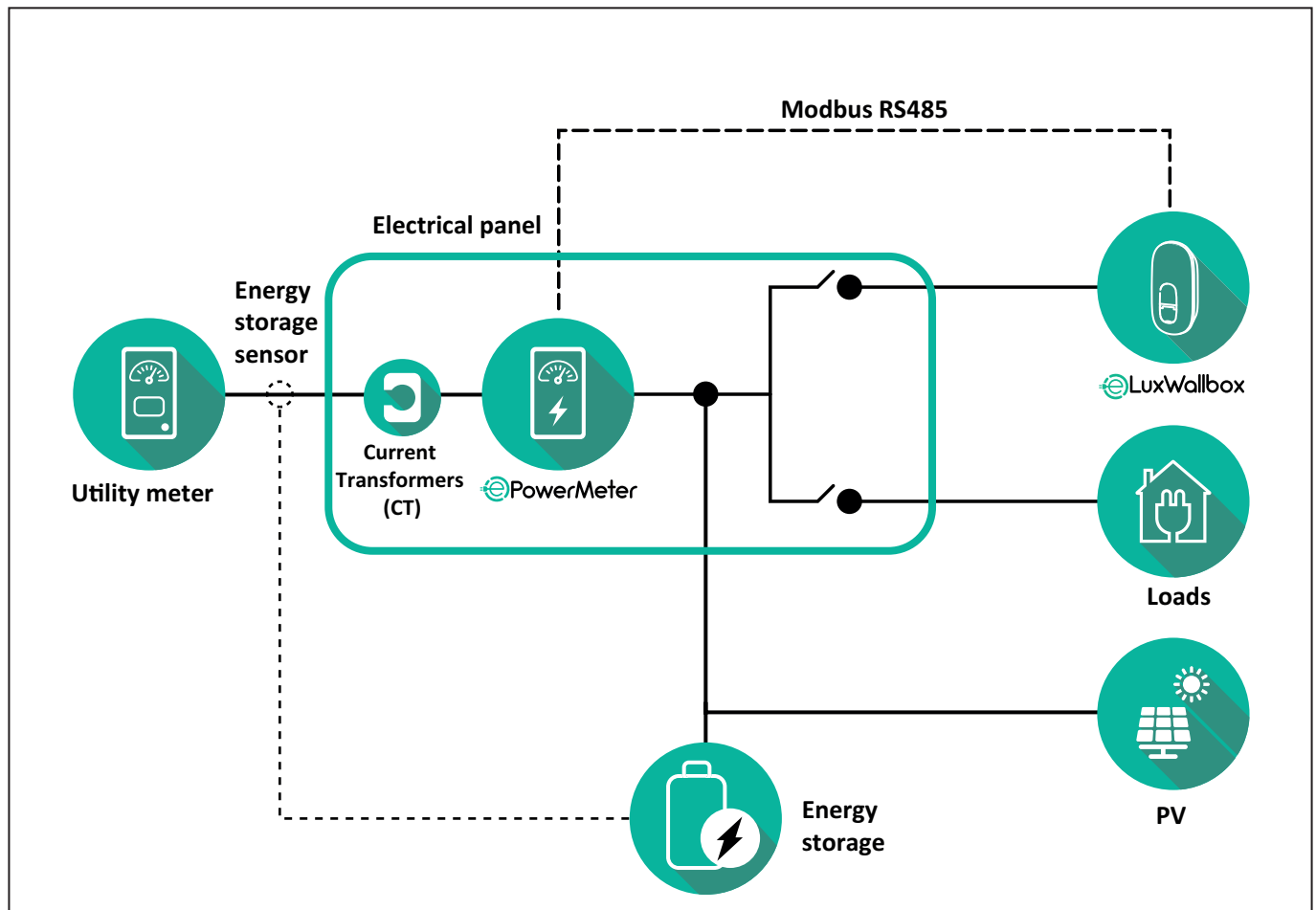

NOTICE:



1) If PV is present, the **PowerMeter** Current Transformers (CT) should be placed between the PV connection point and the Utility Meter.

2) If there is a home Energy storage, the **PowerMeter** Current Transformers (CT) should be placed between the Energy storage connection point and the Energy storage measurement sensor.

Connect the Current Transformers (CT) as indicated in the meter installation manual. Point the arrow on the CT in the direction of the loads.

For the three-phase or single-phase electrical connection of the indirect **PowerMeter**, refer to the diagrams below.

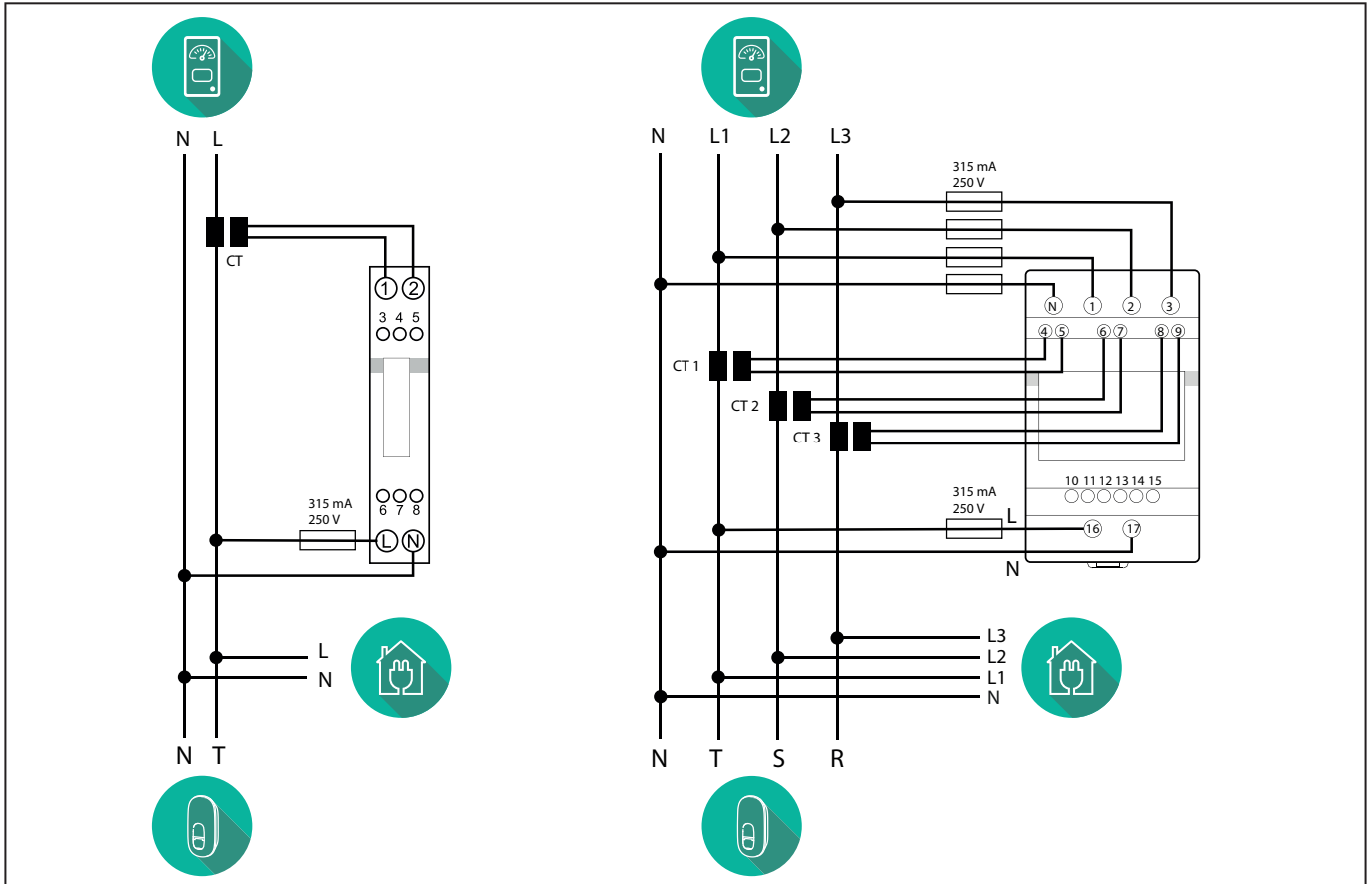

3.2. Installing MIDcounter

The **MIDcounter** is a certified energy meter that allows the consumption of the charger to be safely and reliably monitored during each charging session.

All the relevant data of the charging sessions is automatically recorded by a certified **MID** meter and transferred from the charger to the Charge Point Management System (CPMS).



WARNING: The power to the charger must remain off during this step.

Place the **MIDcounter** on the same power line as the charger, after the electrical protection devices.

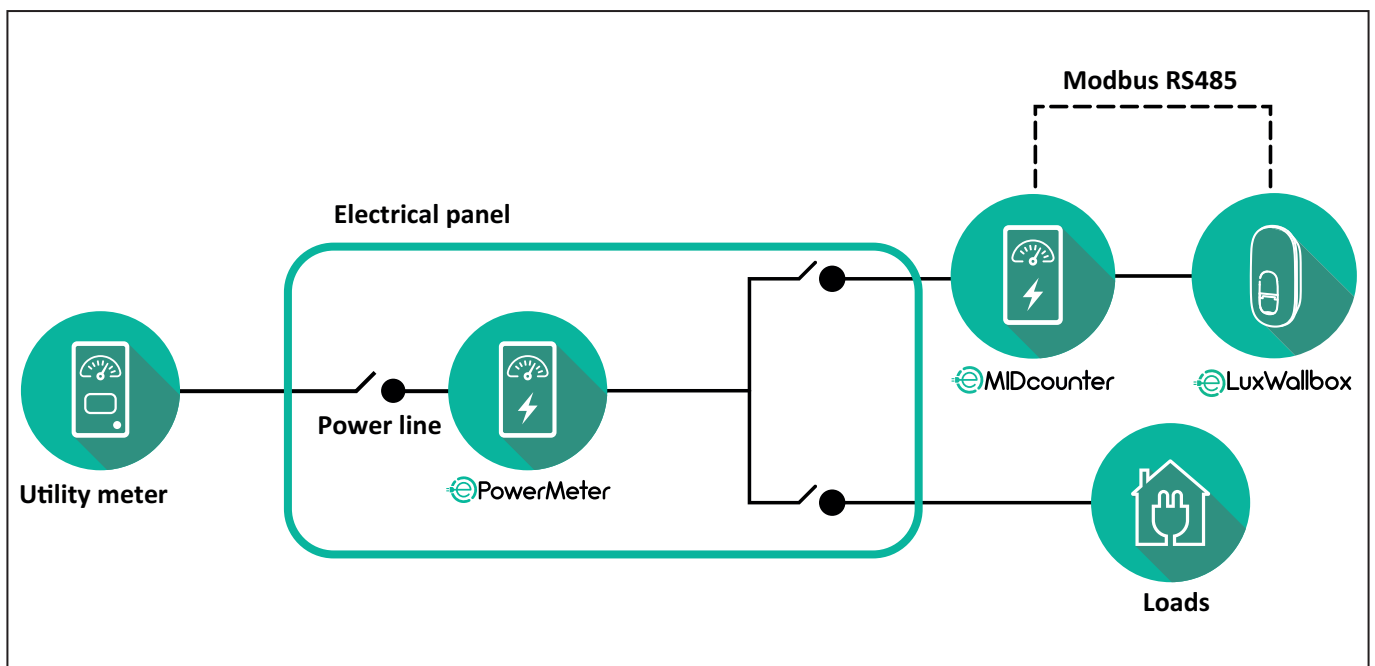

See the diagrams below for single phase and three phase electrical connection of **MIDcounter** (Finder and Gavazzi).

**Finder 1-phase, Direct, 40 A
(7M2482300210)**

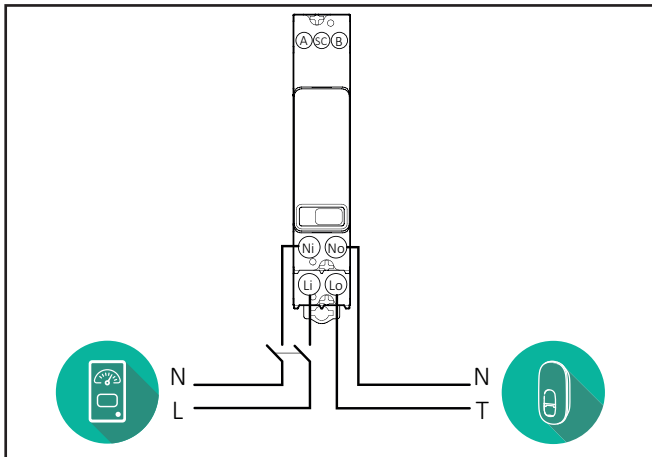

**Gavazzi, 3-phase, Direct, 65 A
(EM340DINAV23XS1PFB)**

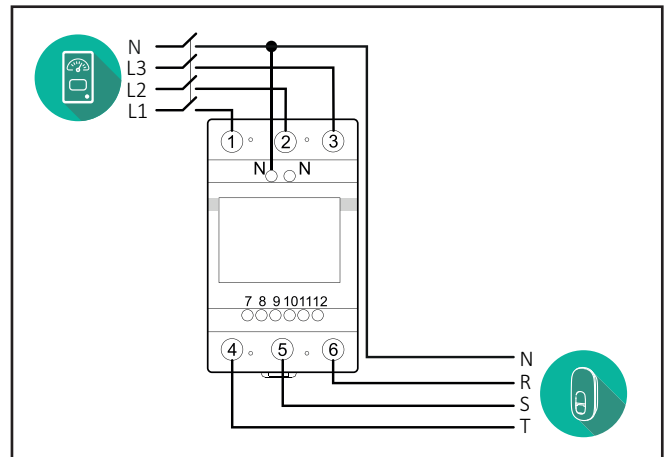

**Finder 3-phase, Direct, 80 A
(7M3884000212)**

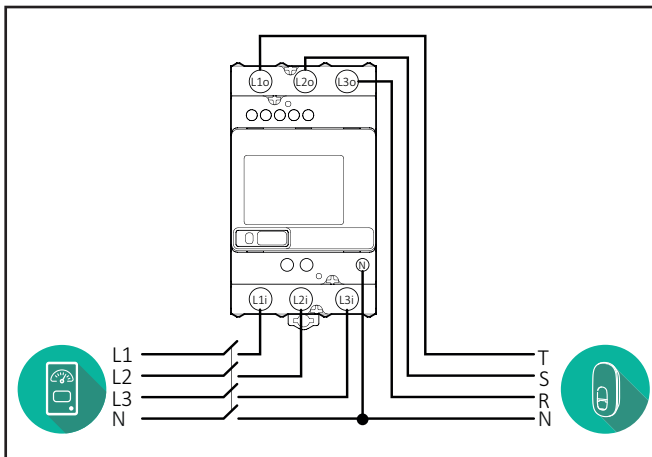

**Gavazzi, 1 phase, Direct, 100 A
(EM112DINAV01XS1PFB)**

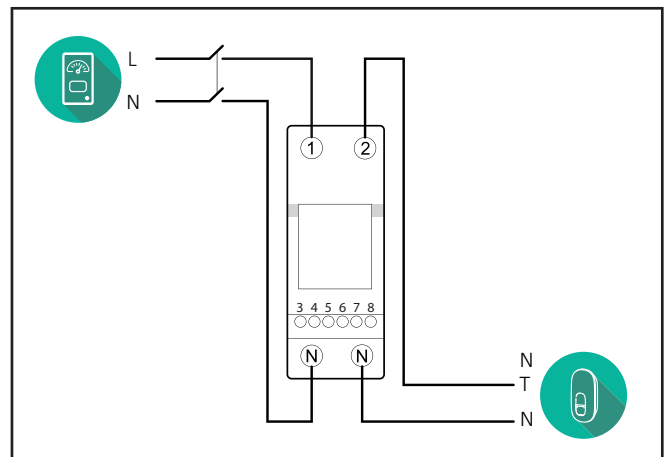

**Gavazzi, 1-phase, Direct, 32 A
(EM111DINAV81XS1PFB)**

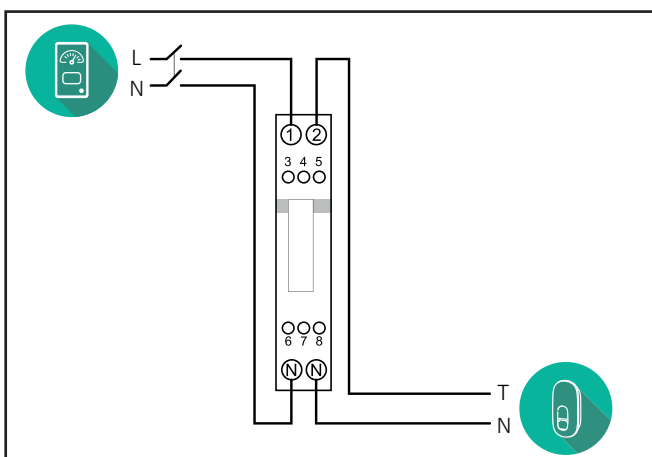

3.3. Communication cable installation

Install a communication cable between the **PowerMeter (DPM)** and the **eLuxWallbox**.

- On the **eLuxWallbox**, remove the protective cap of the communication cables entry point and insert the \varnothing 25 mm corrugated sheath.
- Tighten the box-cable sheath junction.
- Insert the communication cable, pulling it to a suitable length so that it reaches the communication port CN12, leaving some slack.
- Connect the Modbus RS485 communication cable to the GND, - and + pins of the CN12 connector.



NOTE: It is possible to replace the box-cable sheath junctions with \varnothing 25mm cable gland (not provided by the manufacturer).

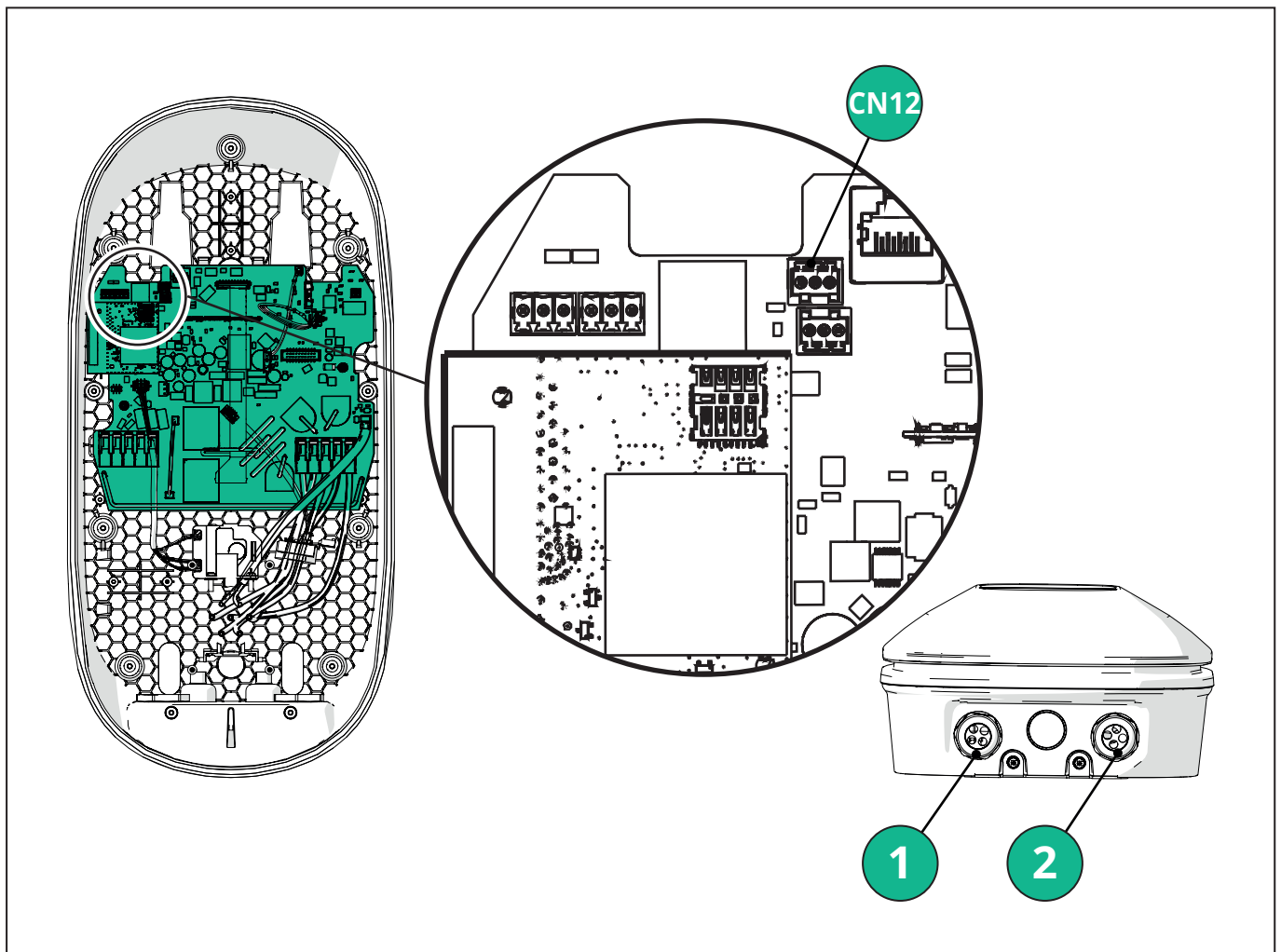

1 - Power supply cables

2 - Communication cables

CN12 - RS485 Modbus for external meter communication (**DPM** and **MID**)

Connect the communication cables in the following order from the **PowerMeter (DPM)** to **eLuxWallbox**.



WARNING: If the installation includes both accessories, follow the instructions for “MIDcounter and PowerMeter (DPM) combined installation”.

CN12	Finder 1ph 7M.24.8.230.0210
GND	SC
-	B
+	A

CN12	Gavazzi 3ph EM340DINAV23XS1PFB
GND	10
-	9
+	8

Junction 9/7

CN12	Finder 3ph 7M.38.8.400.0212
GND	SC
-	B
+	A

CN12	Gavazzi Ind 1ph EM111DINAV51XS1X / EM111DINMV51XS1X
GND	7
-	8
+	6

Junction 8/5

CN12	Gavazzi 1ph EM111DINAV81XS1PFB
GND	7
-	8
+	6

Junction 8/5

CN12	Gavazzi Ind 3ph EM330DINAV53HS1X
GND	13
-	12
+	11

Junction 12/10

3.4. MIDcounter and PowerMeter (DPM) combined installation

If installing both electrical accessories, the positioning of **MIDcounter** together with the **PowerMeter (DPM)** is indicated in the diagram below:

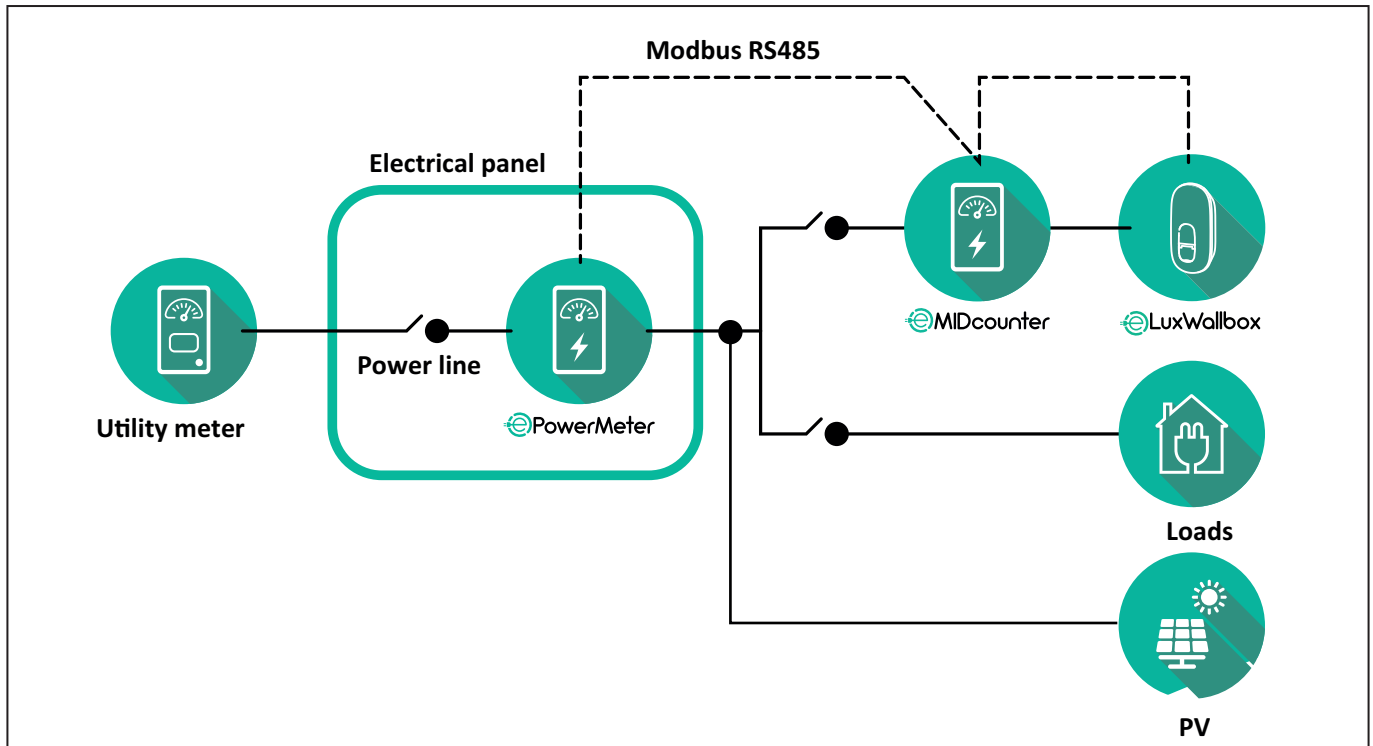

Connect the Modbus communication cables. The **PowerMeter (DPM)**, **MIDcounter** and the **eLuxWallbox** must be connected on the same communication bus in a Daisy chain format.

On the **eLuxWallbox**:

- Remove the protective cap of the communication cable entry point and insert the \varnothing 25 mm corrugated sheath.
- Tighten the box-cable sheath junction.
- Insert the communication cable, pulling it to a suitable length so that it reaches the communication port CN12, leaving some slack.
- Connect the Modbus RS485 communication cable to the GND, - and + pins of the CN12 connector.

Use the table below to connect the communication cables from the accessories to the **eLuxWallbox**.

Single-Phase.

PowerMeter (DPM)	MIDcounter	eLuxWallbox
EM111DINAV51XS1X - EM111DINMV51XS1X	EM111DINAV81XS1PFB	CN12
GND (7)	GND (7)	GND
A- (8) / T*(5)	A- (8)	-
B+ (6)	B+ (6)	+
EM111DINAV51XS1X - EM111DINMV51XS1X	7M 24.8.230.0210	CN12
GND (7)	SC	GND
A-(8) / T*(5)	B-	-
B+ (6)	A+	+
EM111DINAV81XS1PFB	EM111DINAV81XS1PFB	CN12
GND (7)	GND (7)	GND
A-(8) / T*(5)	A- (8)	-
B+ (6)	B+ (6)	+
EM111DINAV81XS1PFB	7M 24.8.230.0210	CN12
GND (7)	SC	GND
A-(8) / T*(5)	B-	-
B+ (6)	A+	+
7M 24.8.230.0210	EM111DINAV81XS1PFB	CN12
SC	GND (7)	GND
B-	A- (8)	-
A+	B+ (6)	+
7M 24.8.230.0210	7M 24.8.230.0210	CN12
SC	SC	GND
B-	B-	-
A+	A+	+

Three-Phase.

PowerMeter (DPM)	MIDcounter	eLuxWallbox
EM330DINAV53HS1X	EM340DINAV23XS1PFB	CN12
GND (13)	GND (10)	GND
A-(12) / T*(10)	A-(9)	-
B+ (11)	B+ (8)	+
EM330DINAV53HS1X	7M.38.8.400.0212	CN12
GND (13)	SC	GND
A-(12) / T*(10)	B-	-
B+ (11)	A+	+
EM340DINAV23XS1PFB	EM340DINAV23XS1PFB	CN12
GND (10)	GND (10)	GND
A-(9) / T*(7)	A-(9)	-
B+ (8)	B+ (8)	+
EM340DINAV23XS1PFB	7M.38.8.400.0212	CN12
GND (10)	SC	GND
A-(9) / T*(7)	B-	-
B+ (8)	A+	+
7M.38.8.400.0212	EM340DINAV23XS1PFB	CN12
SC	GND (10)	GND
B-	A-(9)	-
A+	B+ (8)	+
7M.38.8.400.0212	7M.38.8.400.0212	CN12
SC	SC	GND
B-	B-	-
A+	A+	+

*A 120 Ω terminating resistor must be installed on the devices at the ends of the Modbus chain. The resistor is present by default in the **eLuxWallbox**. Gavazzi models have a built-in resistor, which can be enabled by making a jumper between these terminals.

4. PowerMeter (DPM) and MIDcounter configuration

Power on the **PowerMeter (DPM)** and/or the **MIDcounter** when the electrical installation and communication installation are complete. Then proceed with the configuration on the display of the meters.

The configuration varies depending on the model.

4.1. Finder models

The following actions help to understand how to set Finder energy meters:

- Press the touchscreen button (a,b) to move between menus and parameters;
- Long press (~ 2 seconds) the touchscreen button (a,b) to enter and confirm selections

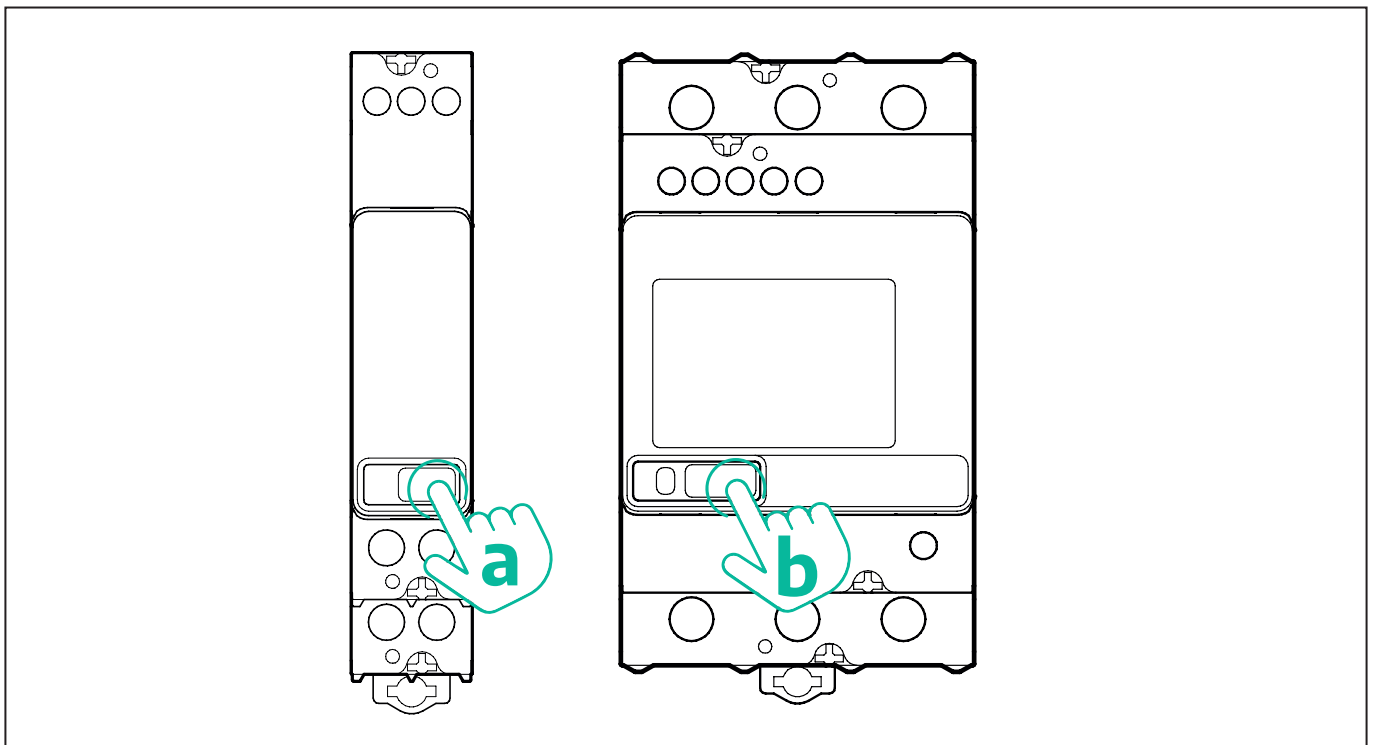

Follow the next steps to correctly configure the single-phase or three-phase Finder energy meters:

- When powering up the energy meter for the first time, long press the touchscreen button (a,b) until the display text blinks in order to enter the "MAIN" menu;
- Scroll the "MAIN" menu pressing the touchscreen button (a,b), then select "SETTING" ("SET" on single-phase meter). Long press to enter the selection.
- Scroll the "SETTING" menu pressing the touchscreen button (a,b), then select "COMMUNICATION" ("COMM" on single phase meter). Long press to enter the selection.
- Insert the correct values indicated in the table below. To modify the value press the touchscreen button (a,b), long press to confirm.

Only for three-phase Finder meter (in addition to previous options):

- Long press the touchscreen button (a,b) until the display text blinks in order to enter the "MAIN" menu (or return to the "MAIN" menu)
- Scroll the "MAIN" menu pressing the touchscreen button (a,b), then select "INSTALLATION". Long press the touchscreen button (a,b) to enter the selection
- Scroll the "INSTALLATION" menu pressing the touchscreen button (a,b) and then select the following option
 - "Communication mode" = "3L+N, L+N-Arithmetic"
 - Once the correct option is confirmed, enter the password: "DCBA" **Attention:** configuration cannot be modified after entering the password **DCBA**
 - Confirm the change selecting "Yes" when prompted.

ALL FINDER MODELS	PowerMeter (DPM)	MIDcounter
DEVICE ADDRESS	1	2
BITS PER SECOND (BAUD)	38400 bit/s	38400 bit/s
PARITY	Even	Even
STOP BIT	1	1
Additional for three-phase type		
	PowerMeter (DPM)	MIDcounter
COMMUNICATION MODE	3L+N, L+N-Arithmetic	3L+N, L+N-Arithmetic
PASSWORD	DCBA	DCBA

4.2. Gavazzi models

The following actions help to understand how to set Gavazzi energy meters:

- Press the touchscreen buttons (c, d, e, g) to move between menus and values
- press (~ 2 seconds) the touchscreen button (d, f) to enter the menu and confirm selections

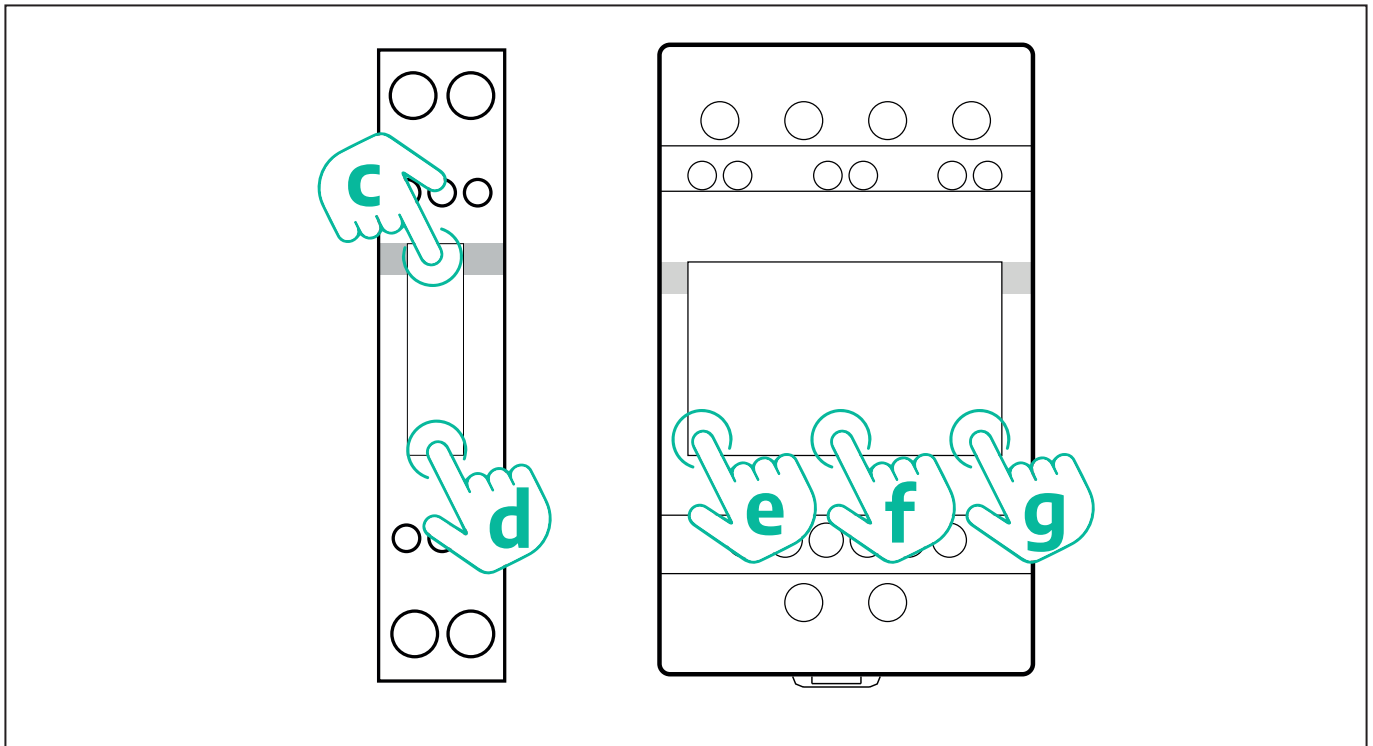

Follow the next steps to correctly configure the single-phase Gavazzi direct and indirect energy meters.

- When powering up the energy meter for the first time, long press the touchscreen button (d) until the password appears on the screen
- Long press the buttons (c, d) simultaneously in order to confirm the password "0000" and enter the "MAIN" menu
- Scroll the "MAIN" menu pressing the upper button (c) and then select the following options in the table below

Follow the next steps to correctly configure the three-phase Gavazzi direct and indirect energy meters:

- When powering up the energy meter for the first time, long press the central button (f) until the password appears on the screen;
- Long press the buttons (e, g) simultaneously in order to confirm the password "0000" and enter the "MAIN" menu
- Scroll the "MAIN" menu pressing the buttons (e or g) and then select the options in the table below

ALL GAVAZZI MODELS	PowerMeter (DPM)	MIDcounter
PASS	0000	0000
ADDRESS	001	002
BAUD	38.4	38.4
PARITY	Even	Even
Additional for three-phase type		
	PowerMeter (DPM)	MIDcounter
SYSTEM	3Pn	3Pn
ADDRESS	001	002

4.3. Device configuration summary

EM340DINAV23XS1PFB / EM330DINAV53HS1X		EM340DINAV23XS1PFB	
PASS	0000	PASS	0000
SYSTEM	3Pn	SYSTEM	3Pn
ADDRESS	1	ADDRESS	2
BAUD	38.4	BAUD	38.4
PARITY	EVEN	PARITY	EVEN

EM111DINAV81XS1PFB / EM111DINAV51XS1X / EM111DINMV51XS1X		EM111DINAV81XS1PFB	
PASS	0000	PASS	0000
ADDRESS	001	ADDRESS	002
BAUD	38.4	BAUD	38.4
PARITY	EVEN	PARITY	EVEN

7M 24.8.230.0210		7M 24.8.230.0210	
DEVICE ADDRESS	__ 1	DEVICE ADDRESS	__ 2
BITS PER SECOND (BAUD)	38400 bit/s	BITS PER SECOND (BAUD)	38400 bit/s
PARITY	EVEN	PARITY	EVEN
STOP BIT	1	STOP BIT	1

7M.38.8.400.0212		7M.38.8.400.0212	
DEVICE ADDRESS	__ 1	DEVICE ADDRESS	__ 2
BITS PER SECOND (BAUD)	38400 bit/s	BITS PER SECOND (BAUD)	38400 bit/s
PARITY	EVEN	PARITY	EVEN
STOP BIT	1	STOP BIT	1
CONNECTION MODE	3L+N, L+N - Arithmetic	CONNECTION MODE	3L+N, L+N - Arithmetic
PASSWORD	DCBA	PASSWORD	DCBA

4.4. PowerMeter (DPM) and MIDcounter configuration on APP

To complete installation, the final configuration of the **eLuxWallbox** and its accessories should be set via the dedicated app

PowerUp is a smartphone app for qualified installers only, available via Google Play™ and Apple Store®. The configuration is carried out via a Bluetooth connection. The wallbox cannot operate correctly if not configured via the app.



NOTICE: Make sure you have the latest version of PowerUp to have access to all of the features.

Follow the instructions below to get started with the app:

Download PowerUp to your smartphone and activate Bluetooth on the smartphone.



Scan **eLuxWallbox** QR code to pair it with the app. The QR Code can be found on the side of the charger.



Once paired, complete the configuration set up of **eLuxWallbox** and its Accessories by clicking on the parameter to be configured.

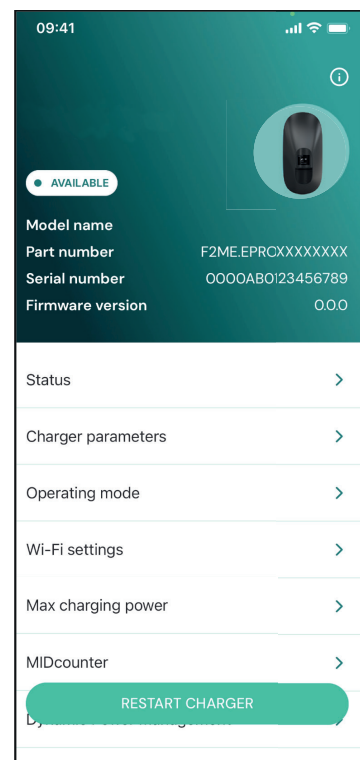

4.5. PowerMeter (DPM) configuration

To complete installation of the **PowerMeter (DPM)**, follow the steps below:

Select "**DPM PowerMeter**" on the homepage

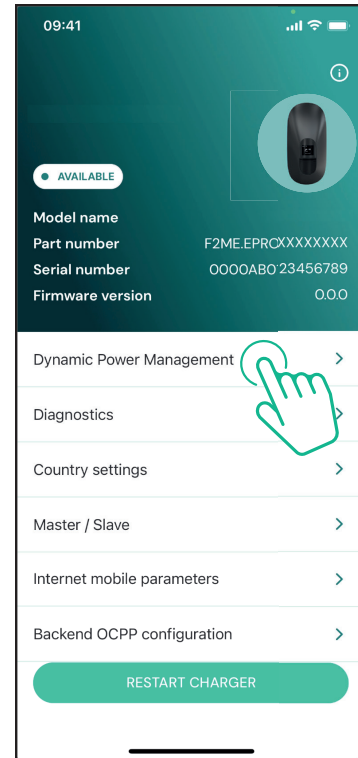

Select the **PowerMeter** type from the drop-down menu, matching the model installed.

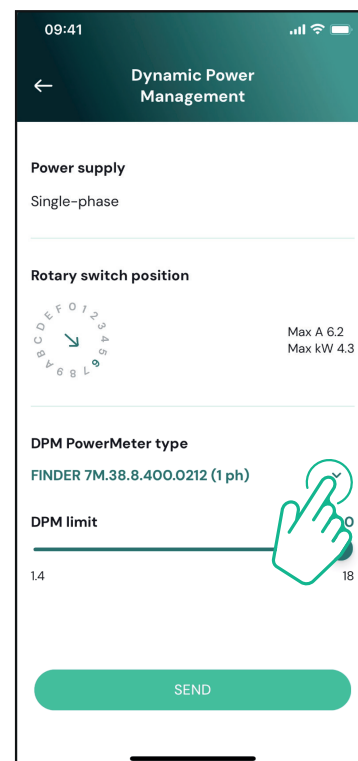

Enter the value of the user contractual power as **DPM** power limit.

For Indirect Meter only - Set the CT current ratio with the slider.

- With CTV 60 A set 60 as Current ratio
- With CTA 100 A set 20 as Current ratio
- With CTA 150 A set 30 as Current ratio

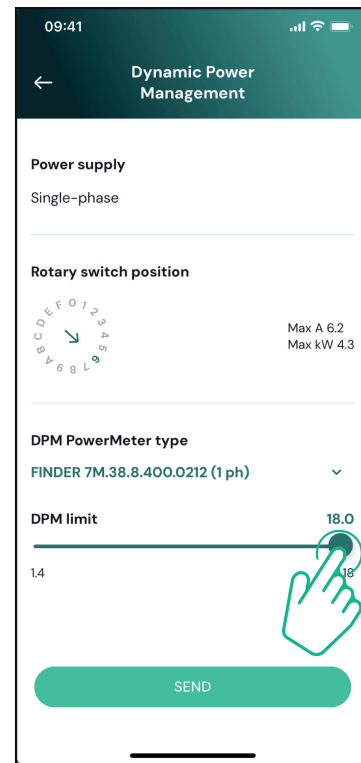

Click "Send" and confirm on the pop-up to restart **eLuxWallbox**.

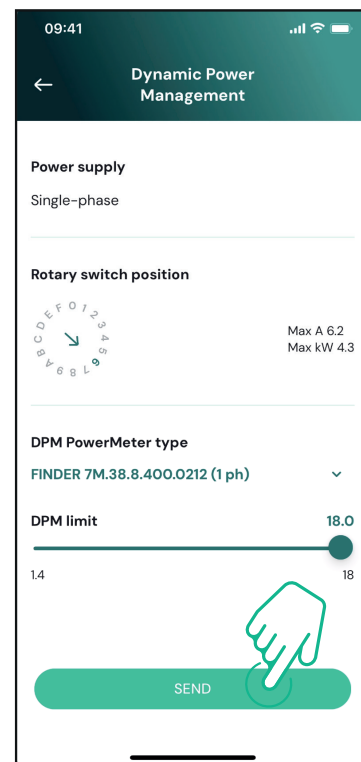

4.6. MIDcounter configuration

To complete installation of the **MIDcounter**, follow the steps below:

Select "**MIDcounter**" on the homepage

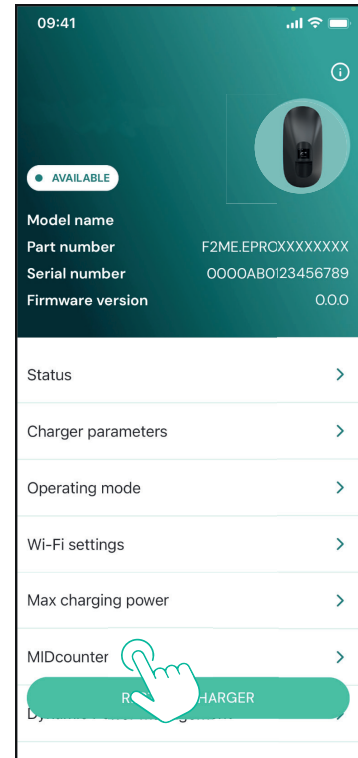

Select the **MIDcounter** type from the drop down menu, based on the model installed.

Select "OFF" from the drop down menu to disable the **MIDcounter** configuration.

Click "Send" to confirm.

To make the changes effective, click on the back arrow in the top left corner and restart **eLuxWallbox** through the dedicated button in the homepage.

If the installation has both the **PowerMeter (DPM)** and the **MIDcounter** it is possible to proceed with **DPM** configuration before restarting.

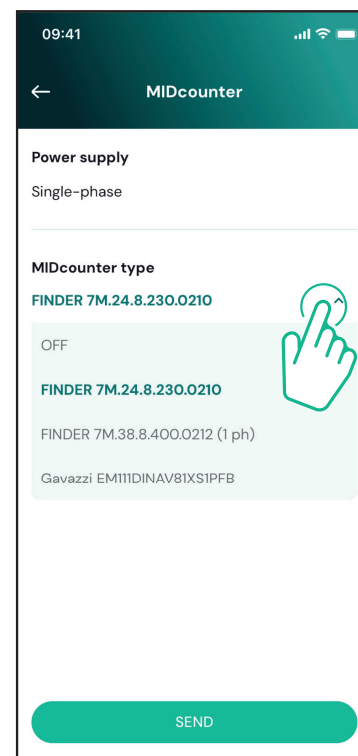

5. TROUBLESHOOTING

Error conditions are stored in the diagnostic logs and shown on the charger panel:

- On the **eLuxWallbox Move** model, the LED bar blinks red. See the **Diagnostic** section of PowerUP or the end-user App for the detailed error code.
- On the **eLuxWallbox** model, the display shows the error code, which is also available in the **Diagnostic** section of PowerUP.

When an error occurs, the charge is interrupted, and the socket is unlocked to allow you to disconnect the plug.

The following table provides a list of errors that can occur and the relative troubleshooting. If the error persists, note the serial number on the charger label and contact Customer Service.

Error code / issue	"Error Description"	Troubleshooting
100	Lack of power supply	<p>Check if the circuit breaker is ON. Check that the CN1 cabling is correct. Check the voltage in CN1.</p>
101	Overheating	<p>Disconnect the Type 2 cable, wait for the temperature to drop, then the error will clear.</p> <p>To restart the charging session, plug in the cable again. Make sure that installation site is compatible with temperature range (25°C/+50°C without direct exposure to sunlight)</p>
102	Communication error between MCU and MPU.	<p>Restart the charger from the circuit breaker, leaving the charger switched off for at least 60 seconds.</p>
103	Hardware fault, ground protection device error (GPD error)	<p>Check the cabling on CN1:</p> <ul style="list-style-type: none"> - in single-phase, make sure that ground cable is connected to PE, the Neutral cable is connected to N and the phase cable to T - in three-phase, make sure that the ground cable is connected to PE, the Neutral cable is connected to N and the phase cables L1, L2 and L3 are connected to T, S, and R. <p>Check whether the voltage difference between PE and N does not exceed 10V. Check PE connection</p> <p>If all connections are checked and the error persists, open the charger and modify the configuration of the Dipswitch (SW2) connector.</p>

104	Hardware fault, residual current monitor AC error. (RCM AC trip)	<p>Try to start a new charging session, removing and plugging in all the connectors.</p> <p>If the problem persists, check for the presence of any problems in the charging cable or vehicle inlet.</p> <p>If the cables and the EV don't show any problem, check CN27 connector and RCM cable.</p>
105	Hardware fault, residual current monitor DC error. (RCM DC trip)	<p>Check that the problem is not with the cable or vehicle. If possible, try another charging session with a different cable or vehicle.</p>
106	Internal meter error	<p>Restart the charger from the circuit breaker, leaving the charger switched off for at least 60 seconds.</p>
107	PowerMeter (DPM) communication error	<p>Check that the communication configuration on the DPM PowerMeter device is correct.</p> <p>Check that the DPM model configuration in the installer App is correct.</p> <p>Check the communication cable wiring on CN12.</p> <p>Check that the communication cable used is suitable for Modbus RS485 and cable length.</p>
108	Configuration Error, Rotary switch position (supply type) is not consistent with the DPM/ MID type.	<p>Check the position of the rotary switch. If it is not consistent with the 1-ph/3-ph installation, change it according to the table in the manual, then restart the charger.</p> <p>If the accessories (DPM/MID) are not installed, make sure that the function is disabled in the installer App.</p> <p>If the accessories (DPM/MID) are installed, check that the correct model is selected on the installer App. Then restart the charger.</p>
109	Main/secondary RS485 communication error	<p>Check the configuration of the Main/Secondary set up from installer App.</p> <p>Check that the Main charger is available.</p> <p>Check that the wiring of the communication cable on CN9 and CN10 is correct.</p> <p>Check that the communication cable used is suitable for Modbus RS485.</p>

110	MIDcounter communication error	<p>Check that the communication configuration on the MIDcounter device is correct.</p> <p>Check the communication cable wiring on CN12.</p> <p>Check that the communication cable used is suitable for Modbus RS485.</p> <p>Check that the MID model configuration in the installer App is correct.</p>
300	Inconsistency between the charger contactor command and feedback	<p>Restart the charger from the circuit breaker, leaving the charger switched off for at least 60 seconds.</p> <p>If error persists even after restart, call Customer Service.</p>
301	Short circuit detected on the Control Pilot line.	<p>With the charger switched off, check that there is no damage and no defects inside and outside the socket (if so, avoid using the charger and contact Customer Service).</p> <p>Check that the problem is not related to the cable or vehicle and try another charge session (with another vehicle or cable if possible).</p>
302	State E or F set on the Control Pilot line.	<p>With the charger switched off, check that there is no damage and no defects inside and outside the cable and its connectors (if so, avoid using it and attempt charge with another cable).</p>
303	Control Pilot disconnected.	<p>Check that the cable connectors are fully inserted inside the charger socket and vehicle inlet.</p>
304	Proximity Pilot disconnected.	<p>Check that the problem is not related to the cable or vehicle and try another charge session (with another vehicle or cable if possible).</p>
305	Broken Proximity Pilot detected.	<p>Check that the problem is not related to the cable or vehicle and try another charge session (with another vehicle or cable if possible).</p>
306	Diode fault detected on Control Pilot line (no - 12V).	<p>Attempt a new charging session unplugging and reinserting the cable from both the charger and vehicle inlet.</p>
307	Control Pilot disconnected.	<p>With the charger switched off, check that there is no damage and no defects inside and outside the cable and its connectors (if so, avoid using it and attempt charge with another cable).</p> <p>Check that the cable connectors are fully inserted inside the charger socket and vehicle inlet.</p> <p>Check that the problem is not related to the cable or vehicle and try another charge session (with another vehicle or cable if possible).</p>

308	Inconsistency between the motor command and feedback, or the motor is in an error condition.	<p>Attempt a new charging session unplugging and reinserting the cable from both the charger and vehicle inlet.</p> <p>Check that the cable connectors are fully inserted inside the charger socket and vehicle inlet.</p>
309	Motor check error during EVSE initialization phase.	Restart the charger from the circuit breaker, leaving the charger switched off for at least 60 seconds.
310	Error detected before charging (PP not detected, or motor fault, or CP not detected).	<p>With the charger switched off, check that there is no damage and no defects inside and outside the cable and its connectors (if so, avoid using it and attempt charge with another cable).</p> <p>Check that the cable connectors are fully inserted inside the charger socket and vehicle inlet.</p>
311	Error detected after charging (motor fault, or CP not disconnected).	Check that the problem is not related to the cable or vehicle and try another charge session (with another vehicle or cable if possible).
312	Emergency stop received from the MPU.	Restart the charger from the circuit breaker, leaving the charger switched off for at least 60 seconds.
313	Current detected during charging, with 100% duty cycle on the Control Pilot line.	Check that the problem is not cable nor vehicle related, attempt a new charging session with another cable and/or charger.
315	Current over limits on phase L1	Unplug the cable, if possible lower the power of charge on the vehicle side and attempt a new charging session.
316	Current over limits on phase L2	
317	Current over limits on phase L3	
318	Voltage below a threshold on phase L1	<p>Check the rotary switch position is consistent with 1-ph/3-ph installation.</p> <p>Check that the voltage on CN1-T is above 196 V.</p> <p>If the voltage is below 196 V, check the electric system or contact the energy supplier.</p> <p>If an error occurs during vehicle charging, try to reduce the set-up charging power and verify that the electric system is correctly dimensioned for the power drawn by the vehicle.</p>

319	Voltage below a threshold on phase L2	The rotary switch is in a three-phase position. Check that the intended installation is in three-phase. If not, select the correct rotary switch position as per Installation Manual.
320	Voltage below a threshold on phase L3	<p>Check that the voltage on CN1-S and R is above 196 V. If the voltage is below 196V, check the electric system or contact the energy supplier.</p> <p>If an error occurs during vehicle charging, try to reduce the set-up charging power and verify that the electric system is correctly dimensioned for the power drawn by the vehicle.</p>
321	Forbidden state change (IEC 61851-1)	<p>EV does not meet IEC 61851-1 standards for starting a charge session.</p> <p>Attempt a new charging session unplugging and reinserting the cable from both the charger and vehicle inlet.</p> <p>If the error persists, contact the vehicle manufacturer.</p>
	Display/LED stuck in Welcome mode (LED blinks red-green-blue)	Restart the charger from the circuit breaker, leaving the charger switched off for at least 60 seconds.
	LED or display does not light up at startup	
	The charger does not start	<p>Let the unit restart, it may take up to 30 seconds.</p> <p>Check if the circuit breaker is ON.</p> <p>Check that the CN1 cabling is correct.</p> <p>Check the voltage in CN1.</p> <p>Restart the charger from the circuit breaker, leaving the charger switched off for at least 60 seconds.</p>
	Cable stuck in the charger socket	Turn off the charger from the circuit breaker, then remove the cable.
	Suspended Charging with solid green LED/ message on the display. The charging session is suspended by the DPM or the EV. The session may resume.	<p>Verify that the max power in the DPM power limit section of the installer App is consistent with the contract power value in kW as indicated in the user's electricity contract. If the value is correct, wait for the charging session to resume or turn off some house loads.</p> <p>In the case of 3-ph installation, verify that the electrical loads are well balanced on the phases of the domestic system.</p>

	<p>App pairing does not complete after QR scan.</p>	<p>Check the integrity of the QR code on the label. Update the App to the latest version. Close and restart the App, then try again. Restart the charger from the circuit breaker, leaving the charger switched off for at least 60 seconds.</p>
--	---	---

6. CLEANING

Cleaning the outside of the device is always recommended when necessary and should be carried out using a soft damp cloth with a mild detergent. When finished, wipe off any traces of moisture or liquid with a soft dry cloth.



CAUTION: Avoid strong jets of air or water as well as the use of soaps or detergents that are too harsh and corrosive for the materials of the charger.

7. PACKAGING DISPOSAL



Dispose of packaging in an environmentally friendly manner. The materials used for packaging this product can be recycled and must be disposed of in compliance with the legislation in force in the country of use. The following disposal directions will be found on the packaging based on the type of material.



NOTE: Further information about current disposal facilities can be obtained from local authorities.

8. ASSISTANCE

If you have any questions about the installation of **eLuxWallbox**. For any other information or requests for support, please contact Free2move eSolutions S.p.A. through the relevant section of its website: www.esolutions.free2move.com.

9. DISCLAIMER

Free2move eSolutions S.p.A. will not be held responsible for any damage directly or indirectly caused to people, things or animals due to the failure to comply with all the provisions set out in this Manual, and the warnings regarding the installation and maintenance of **eLuxWallbox**.

Free2move eSolutions S.p.A. reserves all rights to this document, the article and the illustrations it contains. The reproduction, whole or in part, disclosure to third parties or use of its contents is prohibited without the prior written consent of Free2move eSolutions S.p.A.

Any information in this manual may be changed without prior notice and does not represent any obligation on the part of the manufacturer. Images in this manual are for illustrative purposes only and might differ from the delivered product.

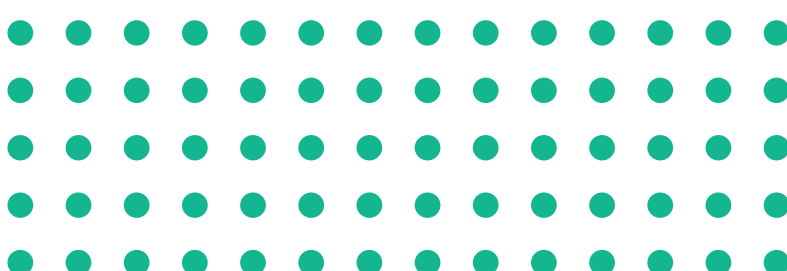

Registered office
Free2move eSolutions S.p.A.
Piazzale Lodi, 3
20137 Milan - Italy
www.esolutions.free2move.com

EN

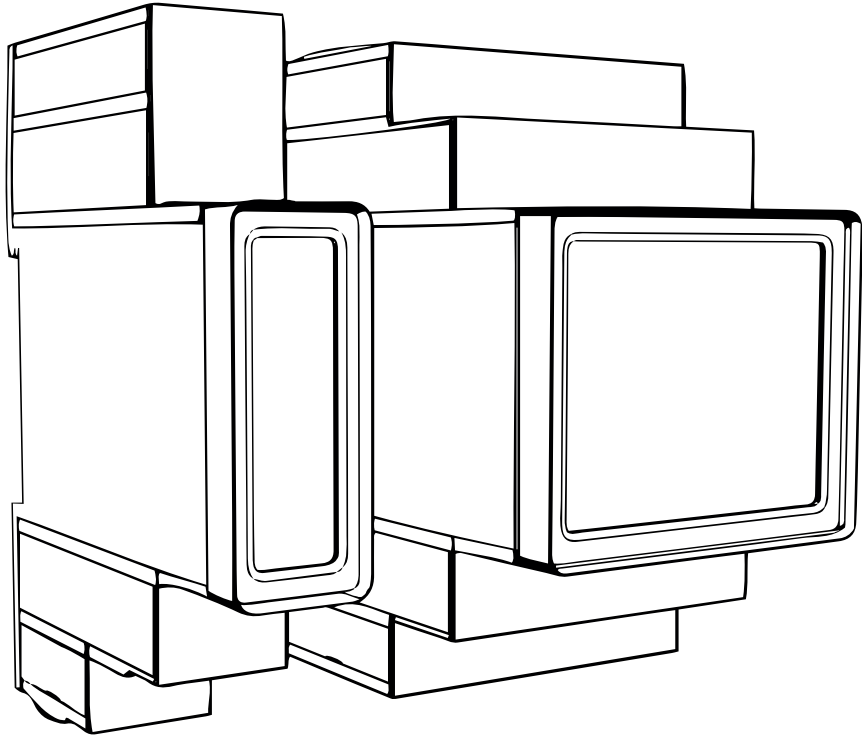
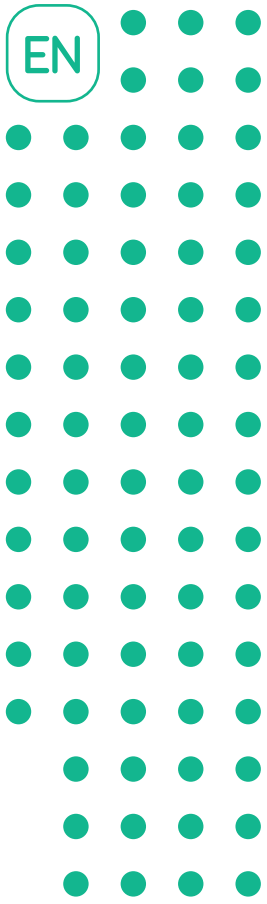

LuxWallbox

Accessories Manual



For safe and proper use,
follow these instructions.
Keep them for future reference

Table of content

1. INTRODUCTION	4
1.1. Purpose of the Manual	4
1.2. Identification of the Manufacturer.....	4
1.3. Structure of the Accessories Manual	4
1.4. Safety	5
1.5. Personal Protective Equipment (PPE).....	6
1.6. Warranty and delivery conditions	6
1.7. List of documents.....	7
1.8. Warnings	7
2. GENERAL INFORMATION	8
2.1. Fields of use	9
3. ACCESSORIES INSTALLATION	10
3.1. Installing PowerMeter (DPM).....	10
3.2. Installing MIDcounter	15
3.3. Communication cable installation	17
3.4. MIDcounter and PowerMeter (DPM) combined installation .	19
4. PowerMeter (DPM) and MIDcounter configuration.	22
4.1. Finder models.....	22
4.2. Gavazzi models.....	24
4.3. Device configuration summary	25
4.4. PowerMeter (DPM) and MIDcounter configuration on APP ..	26
4.5. PowerMeter (DPM) configuration	28
4.6. MIDcounter configuration.....	30
5. TROUBLESHOOTING.....	31
6. CLEANING.....	36
7. PACKAGING DISPOSAL	36
8. ASSISTANCE.....	37
9. DISCLAIMER.....	37



1. INTRODUCTION

1.1. Purpose of the Manual

This installation manual is a guide to help operators to work safely and carry out the installation operations needed to keep the charger in good working order.

The purpose of this document is to support qualified technicians who have received appropriate training, and demonstrated suitable skills and knowledge in the construction, installation, operation and maintenance of electrical equipment.

If the charger is used in a manner not specified in this manual, the protection provided by the charger may be impaired. This document contains the information required for the installation of the charger.

This document has been carefully checked by the Manufacturer Free2move eSolutions S.p.A. but oversights cannot be completely ruled out. If any errors are noted, please inform Free2move eSolutions S.p.A. Except for explicit contractual obligations, under no circumstances may Free2move eSolutions S.p.A. be held liable for any loss or damage resulting from the use of this manual, or from installation of the equipment. This document was originally written in English. In the event of any inconsistencies or doubts, please ask Free2move eSolutions S.p.A. for the original document.

1.2. Identification of the Manufacturer

The manufacturer of the charger is:

Free2move eSolutions S.p.A.

Piazzale Lodi, 3

20137 Milan – Italy

www.esolutions.free2move.com

1.3. Structure of the Accessories Manual





This manual is divided into chapters based on different topics and containing all the information that is needed to install the charger safely.

Each chapter is sub-divided into paragraphs which examine the fundamental points, and each paragraph may have its own title, along with sub-titles and a description.

1.4. Safety

This manual contains important safety instructions that must be followed during installation of the charger.

In order to fulfil this objective, this manual contains a number of precautionary texts, containing special instructions. These instructions are highlighted by a specific text box and are accompanied by a symbol, and are provided in order to ensure the safety of the personnel required to perform the operations described, and to avoid any damage to the charger and/or property:

	<p>This symbol means: DANGER</p> <p>This symbol is intended to highlight a dangerous situation for yourself and others. Read it carefully. Failure to comply with the instruction will result in an imminent hazardous situation which, if not avoided, will result in instant death, or serious or permanent injury.</p>
	<p>This symbol means: WARNING</p> <p>This symbol is intended to highlight safety information. Failure to comply with the instruction will result in a potentially hazardous situation which, if not avoided, could result in death or serious injury.</p>
	<p>This symbol means: CAUTION</p> <p>This symbol is intended to highlight safety information. Read it carefully. Failure to follow these instructions can result in death, serious injury or damage to equipment.</p>
	<p>This symbol means: NOTE</p> <p>Provides additional information to supplement instructions provided.</p>
	<p>This symbol means: NOTICE</p> <p>Provides instructions concerning the use of conduct necessary to handle the operations not associated with possible physical injuries.</p>

Installation must be carried out by qualified personnel. A dedicated, state-of-the-art electricity supply system must be designed and installed, and the system must be certified in compliance with local regulations and the energy supply contract.

Operators are required to read and fully understand this manual, and to comply strictly with the instructions it contains.

Free2move eSolutions S.p.A. cannot be held liable for damage caused to persons and/ or property, or to the equipment, if the conditions described in this document have not been complied with.





WARNING: Installation must be carried out in accordance with the regulations in force in the country of installation, and in compliance with all safety regulations for carrying out electrical work.

1.5. Personal Protective Equipment (PPE)

Personal Protective Equipment (PPE) means any equipment intended to be worn by the workers in order to protect them against one or more hazards likely to threaten their health or safety at the workplace, as well as any device or accessory intended for this purpose.

Since all the PPE indicated in this manual is intended to protect the personnel against health and safety hazards, the Manufacturer of the charger which is the subject of this manual recommends strict compliance with the indications contained in the various sections of this manual.

The list of PPE to be used in order to protect the operators against the residual risks present during the installation and maintenance interventions described in this document is provided below.

Symbol	Meaning
	Wear protective gloves
	Wear anti-static footwear



WARNING: It is responsibility of the operator to read and understand local regulations and evaluate the environmental conditions of the installation site in order to comply the need to wear additional PPE.

1.6. Warranty and delivery conditions

The warranty details are described in the Terms and Conditions of Sale included with the purchase order for this product and/or in the packaging of the product.

Free2move eSolutions S.p.A. assumes no responsibility for failure to comply with the instructions for proper installation, and cannot be held responsible for systems upstream or downstream of the equipment supplied.

Free2move eSolutions S.p.A. cannot be held responsible for defects or malfunctions deriving from: improper use of the charger; deterioration due to transport or particular environmental conditions or installation by unqualified persons.

Free2move eSolutions S.p.A. is not responsible for any disposal of the equipment, or parts thereof, that does not comply with the regulations and laws in force in the country of installation.



NOTICE: Any modification, manipulation or alteration of the hardware or software not expressly agreed with the manufacturer will immediately void the warranty.

1.7. List of documents

In addition to this manual, product documentation can be viewed and downloaded by visiting: www.esolutions.free2move.com.

1.8. Warnings



DANGER: Risk of electric shock and fire. Installation must be carried out in accordance with the regulations in force in the country of installation, and in compliance with all safety regulations for carrying out electrical work.

- Before installing or using the device, make sure that none of the components have been damaged. Damaged components can lead to electrocution, short circuits, and fire due to overheating. A device with damage or defects must not be used.
- Install **eLuxWallbox** away from petrol cans or combustible substances in general.
- Before installing **eLuxWallbox compatible accessories**, ensure the main power source has been disconnected.
- The **eLuxWallbox compatible accessories** must only be used for the specific applications they are designed for.
- Installation not carried out correctly may pose risks to the user.
- The charger must be connected to a mains network in compliance with local and international standards, and all the technical requirements indicated in this manual.
- Children or other persons not able to gauge risks related to the installation of the charger could suffer serious injury or put their lives at risk.
- Pets or other animals must be kept away from the device and packaging material
- Children must not play with the device, accessories or packaging provided with the product.
- The only part that can be removed from **eLuxWallbox**, is the removable cover. Access under the cover is only permitted by qualified personnel during installation, dismantling or maintenance.
- **eLuxWallbox** can only be used with an energy source.
- Necessary precautions to ensure safe operation with Active Implantable Medical Devices must be taken. To determine whether the charging process could adversely affect the medical device, please contact its manufacturer.

2. GENERAL INFORMATION

eLuxWallbox is an Alternate Current charging solution for powering electric vehicles and hybrid plug-ins, and is ideal for semi-public and residential use. The charger is available in three-phase or single-phase configurations and is equipped with a Type 2 socket.

The charger charges electric vehicles up to 22 kW in three-phase, or up to 7.4 kW in single-phase. The charger includes connectivity options such as remote monitoring via the eSolutions control platform (CPMS). Its final configuration must be completed using the **PowerUp** application. For the end user, the **eLuxWallbox** can be managed via the dedicated user's eSolutions Charging App. Both applications are available on Google Play™ and Apple Store®.

This charger is equipped with a SIM card for connection to the 4G mobile network.

The SIM card is automatically activated the first time the charger is turned on.

This document describes how to install the external accessories compatible with the **eLuxWallbox**.

The external accessories described in this manual are:

- **PowerMeter (DPM)**: an energy meter that enables the Dynamic Power Management (**DPM**) which is a smart function that allows an electric vehicle to be recharged using only the power available at home, modulating the charging power and avoiding unpleasant blackouts.
- **MIDcounter**: a certified energy meter that allows to monitor the consumption of the **eLuxWallbox** during each charging session.

This manual contains a description of the characteristics of the different accessories, information on models, installation process and final configuration of the devices.

The **eLuxWallbox** is configured to be used with the following electrical accessories: **PowerMeter (DPM)** or **MIDcounter**:

- Gavazzi, 1-phase, Direct, 32 A
- Finder, 1-phase, Direct, 40 A
- Gavazzi, 3-phase, Direct, 65 A
- Finder, 3-phase, Direct, 80 A

PowerMeter (DPM):

- Gavazzi, 1-phase, Indirect with 1x CT 100 A
- Gavazzi, 1-phase, Indirect with 1x CTV 60 A
- Gavazzi, 3-phase, Indirect with 3x CT 150 A



WARNING: Do not try to install the Electrical Accessories if you are not qualified as a professional electrician. To do so could cause serious danger and harm to you and to the people, property or animals around you.

To complete the installation, it is necessary to configure the **eLuxWallbox** through the dedicated apps:

	Installer's app: PowerUp
Product versions (EU):	EPRO23S224GWBAX
Product versions (UK):	EPRO23S224GWBAS



WARNING: Only Electrical Accessories suggested by Free2move eSolutions S.p.A. are compatible. Installation must be performed by qualified personnel in accordance with local regulations.

2.1. Fields of use

Free2move eSolutions S.p.A. declines all liability for any damage whatsoever due to incorrect or careless actions.

The charger may not be used for any purpose other than the one it is intended to fulfill.

The equipment must not be used by children or people with limited mental or physical abilities, or even by adults or expert professionals if the charger undergoes operations that do not comply with this manual and accompanying documentation.

The charger is a charging device for electric vehicles; the following classification (according to IEC 61851-1) identifies its characteristics:

- Power supply: permanently connected to the AC power supply grid
- Output: Alternate Current
- Environmental conditions: indoor / outdoor use
- Fixed installation
- Protection against electric shock: Class I
- EMC Environment classification: Class B
- Charging type: Mode 3 according to the IEC 61851-1 standard
- Optional function for ventilation not supported

3. ACCESSORIES INSTALLATION

To install the electrical accessories, it is necessary to use Modbus communication cables with the following characteristics:

- Modbus RS485 twisted STP 2x2 AWG24 or S/FTP cat.7 suitable for installation with a 400V power line
- Conductor size: 0.5 mm²
- Stripping length: 10 mm
- Recommended maximum length: 150 m

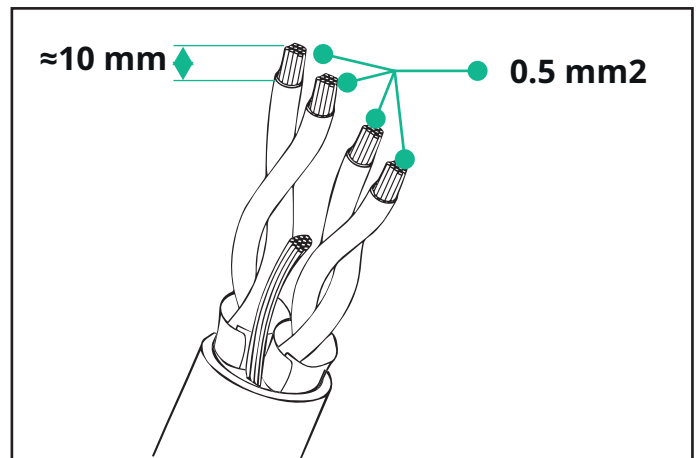

3.1. Installing PowerMeter (DPM)

PowerMeter (DPM) is an energy meter that enables the Dynamic Power Management (**DPM**) which is a smart function that allows an electric vehicle to be recharged using only the power available at home, modulating the charging power and avoiding unpleasant blackouts. Whenever other appliances are being used during the charging session, the system can modulate the charging power towards the car, even temporarily suspending the charging session. As soon as the other domestic appliances are switched off, the session will resume.

The **DPM** smart logic works both in three-phase and in single-phase installations.



WARNING: When installing in three-phase systems, make sure that the electrical loads (including the wallbox) are well balanced between the phases of the electrical system.



WARNING: Before carrying out any installation or maintenance work on the device, it must be ensured that the power supply is switched off.

For Direct models of the PowerMeter (DPM):

Place the **PowerMeter (DPM)** after the main utility meter. The **PowerMeter (DPM)** must measure all the electrical loads, including the **eLuxWallbox**.

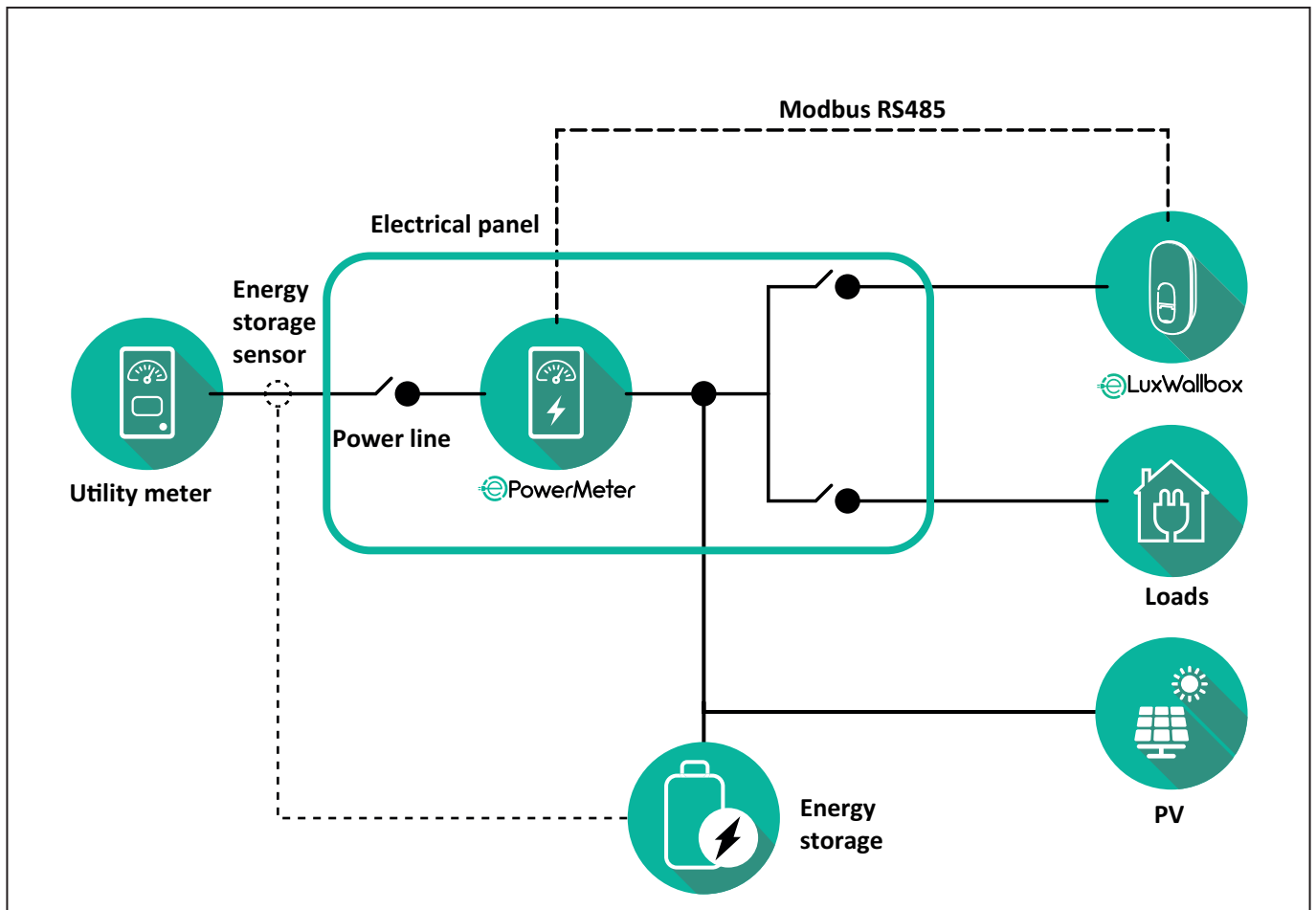

For Direct models of the PowerMeter:



WARNING: During the installation always refer to the manufacturer installation manual provided with the meter.



NOTE: For the single-phase or three-phase electrical connection of the Direct **PowerMeter**, please refer to the diagrams below.

Finder model 1ph and 3ph

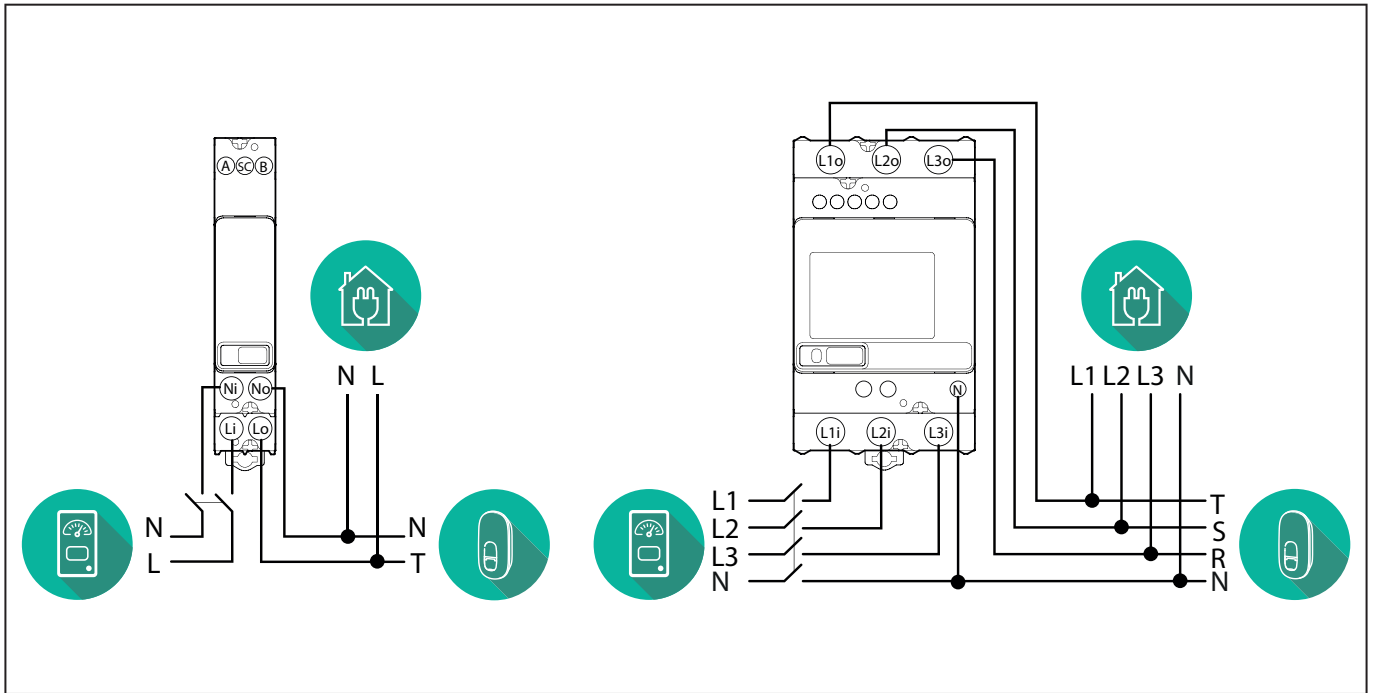

Gavazzi model 1ph and 3ph

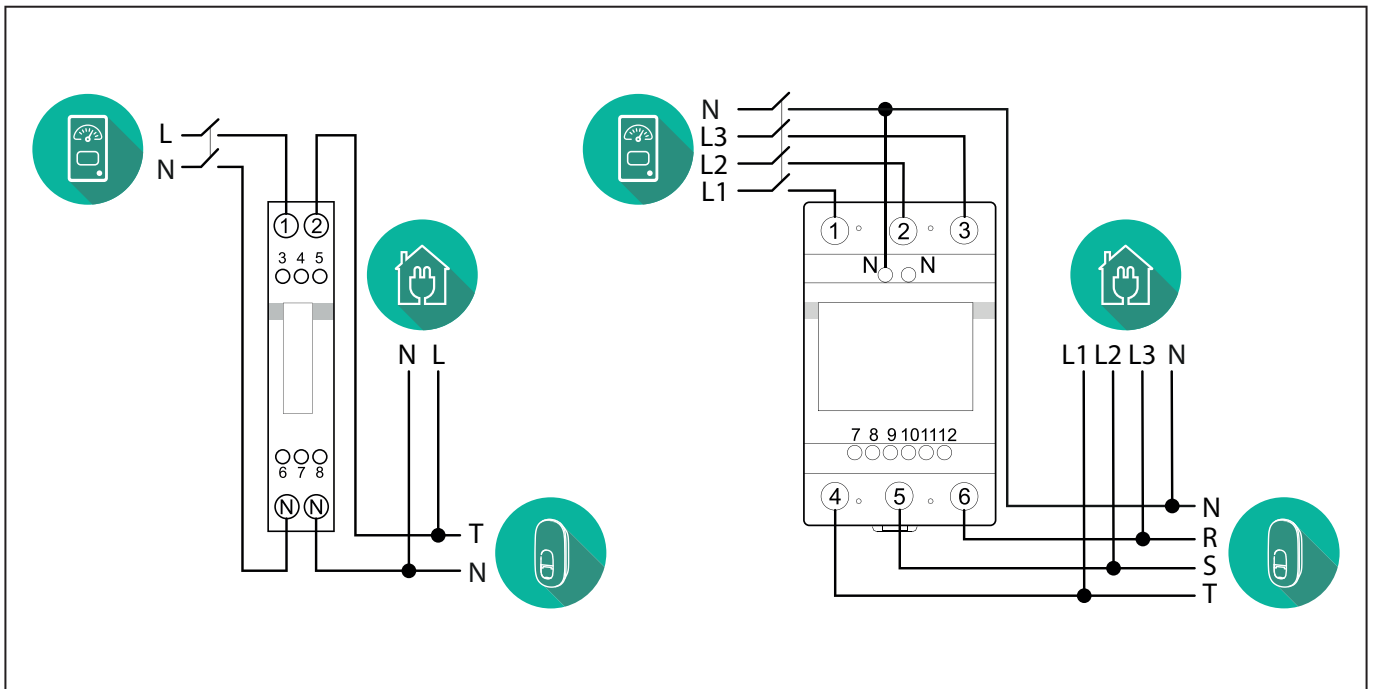

NOTICE:



- 1) If PV is present, the **PowerMeter** should be placed between the Utility Meter and the PV connection point.
- 2) If there is a home Energy storage, the **PowerMeter** should be placed between the Energy storage connection point and the Energy storage measurement sensor.

For Indirect models of the PowerMeter:

Place the CT (current transformer) of the **PowerMeter** after the main utility meter and before the main switch of the house/building. The current transformer must measure all the domestic loads, including the **eLuxWallbox**.

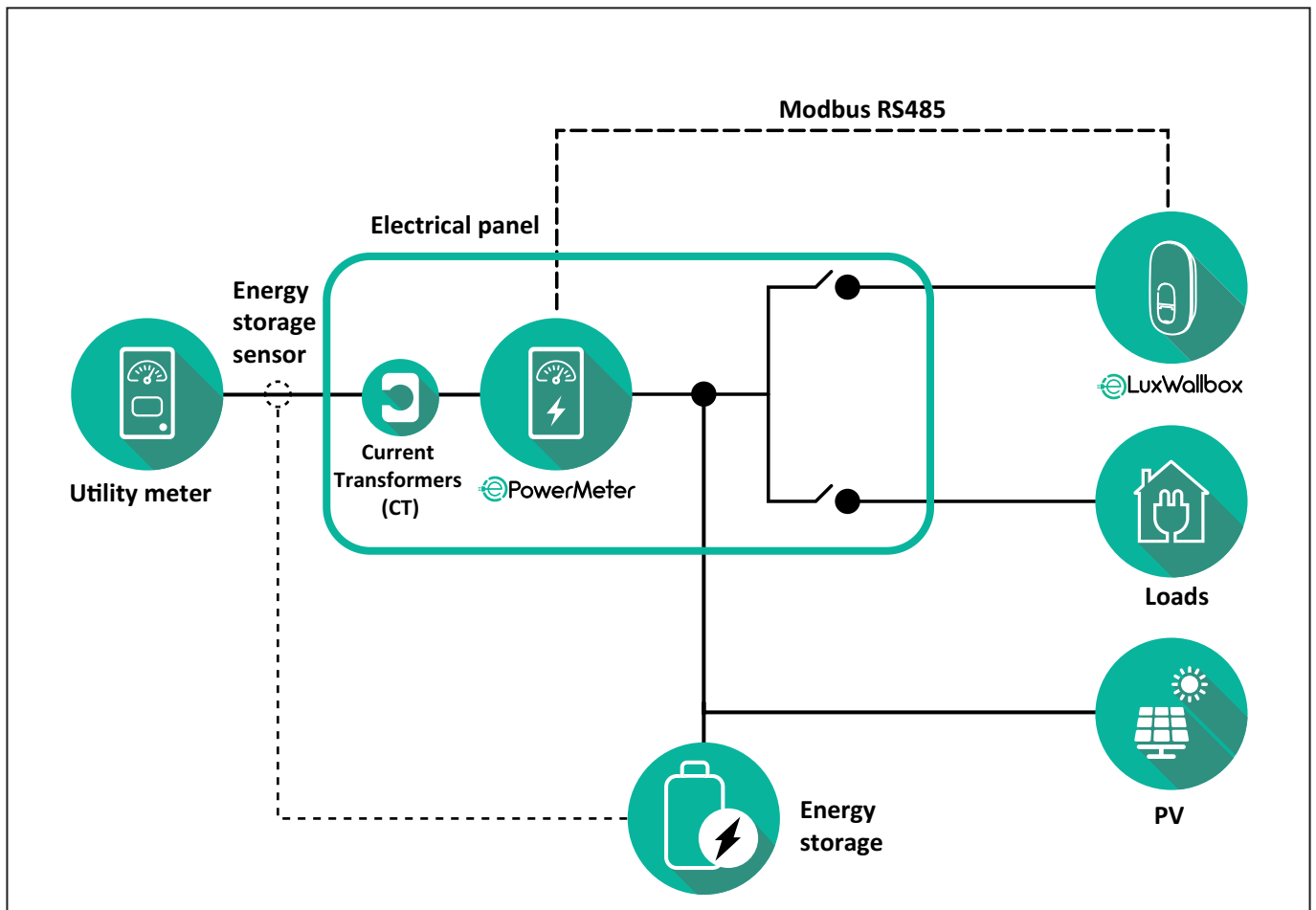

NOTICE:



1) If PV is present, the **PowerMeter** Current Transformers (CT) should be placed between the PV connection point and the Utility Meter.

2) If there is a home Energy storage, the **PowerMeter** Current Transformers (CT) should be placed between the Energy storage connection point and the Energy storage measurement sensor.

Connect the Current Transformers (CT) as indicated in the meter installation manual. Point the arrow on the CT in the direction of the loads.

For the three-phase or single-phase electrical connection of the indirect **PowerMeter**, refer to the diagrams below.

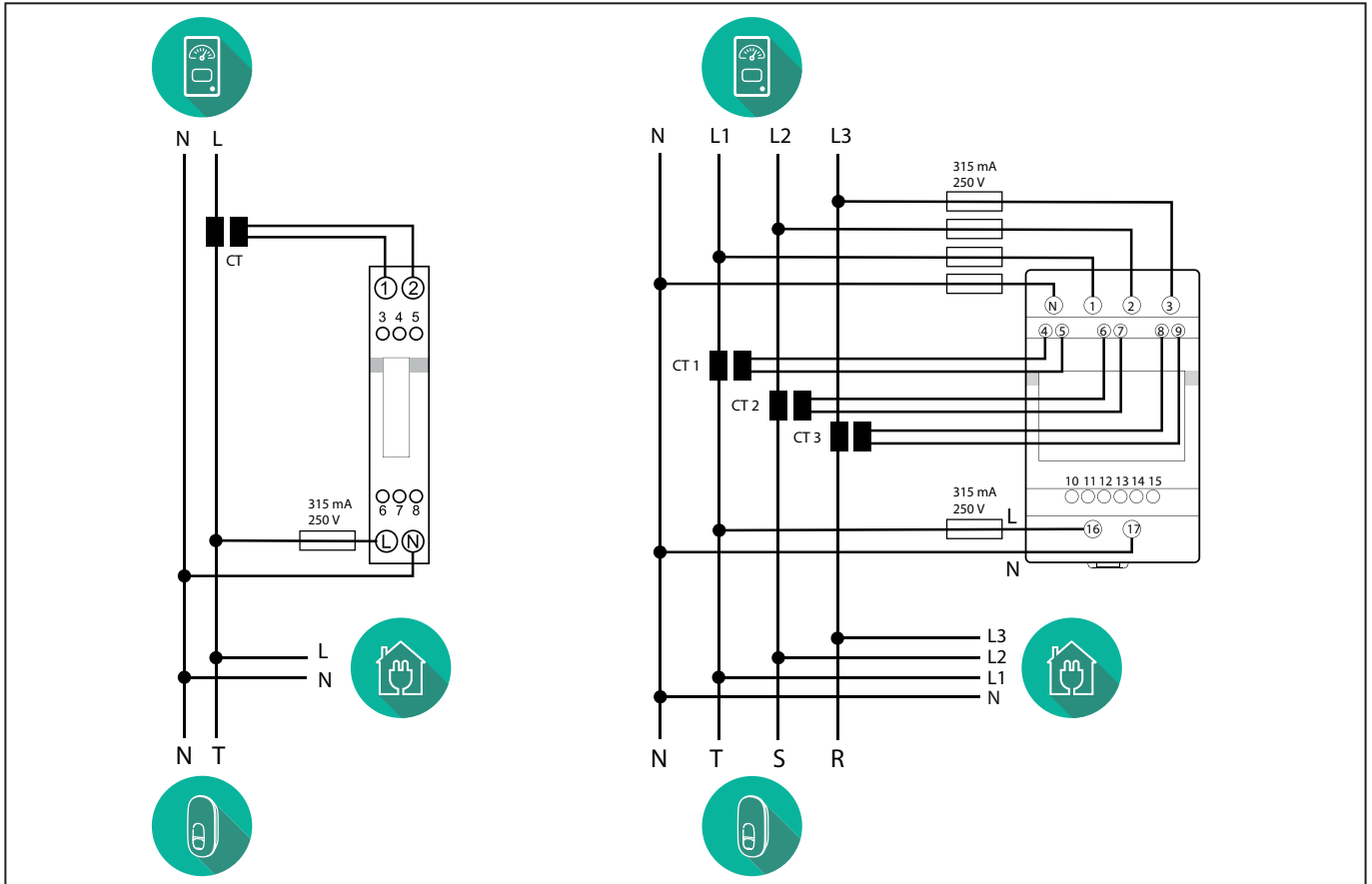

3.2. Installing MIDcounter

The **MIDcounter** is a certified energy meter that allows the consumption of the charger to be safely and reliably monitored during each charging session.

All the relevant data of the charging sessions is automatically recorded by a certified **MID** meter and transferred from the charger to the Charge Point Management System (CPMS).



WARNING: The power to the charger must remain off during this step.

Place the **MIDcounter** on the same power line as the charger, after the electrical protection devices.

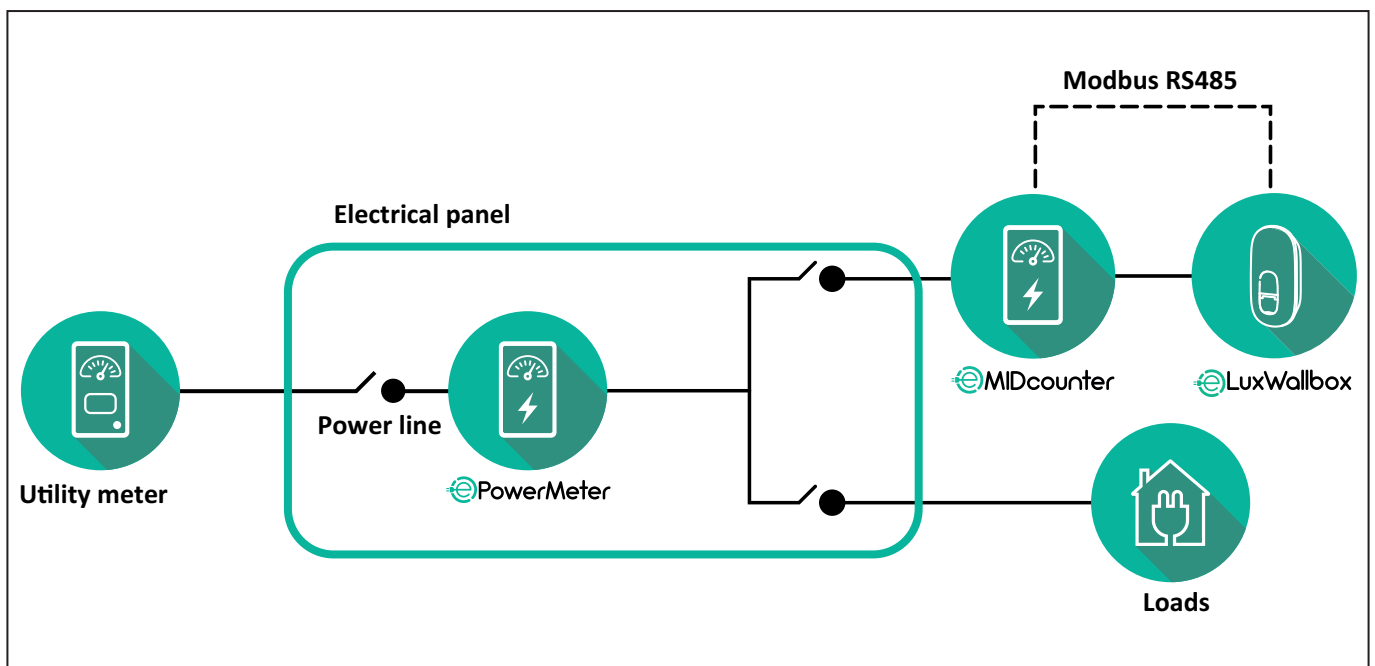

See the diagrams below for single phase and three phase electrical connection of **MIDcounter** (Finder and Gavazzi).

**Finder 1-phase, Direct, 40 A
(7M2482300210)**

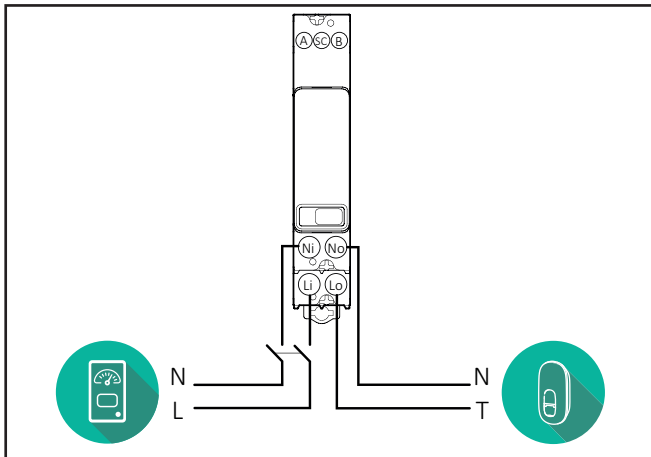

**Gavazzi, 3-phase, Direct, 65 A
(EM340DINAV23XS1PFB)**

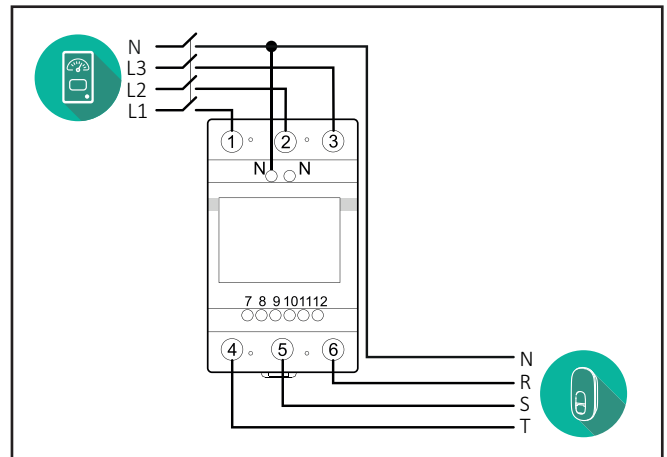

**Finder 3-phase, Direct, 80 A
(7M3884000212)**

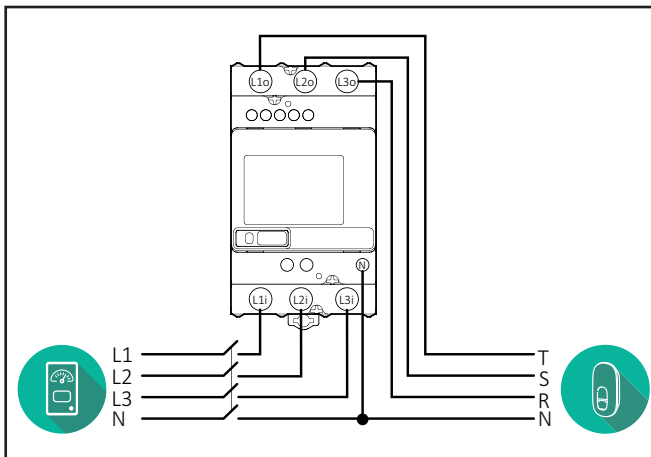

**Gavazzi, 1 phase, Direct, 100 A
(EM112DINAV01XS1PFB)**

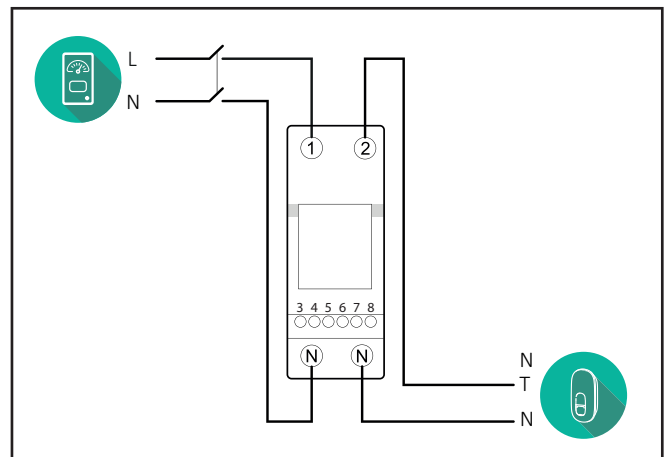

**Gavazzi, 1-phase, Direct, 32 A
(EM111DINAV81XS1PFB)**

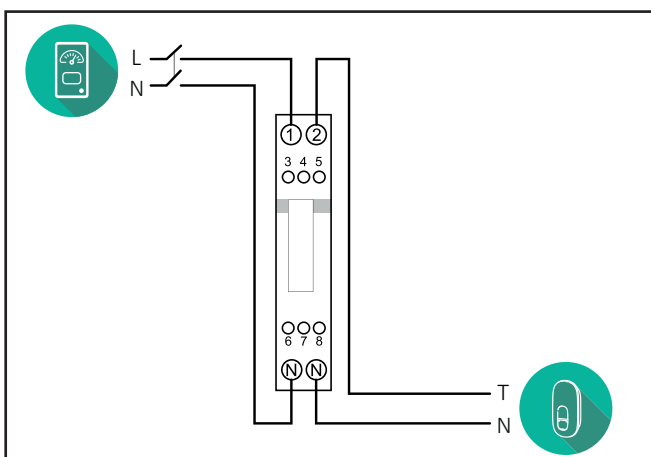

3.3. Communication cable installation

Install a communication cable between the **PowerMeter (DPM)** and the **eLuxWallbox**.

- On the **eLuxWallbox**, remove the protective cap of the communication cables entry point and insert the \varnothing 25 mm corrugated sheath.
- Tighten the box-cable sheath junction.
- Insert the communication cable, pulling it to a suitable length so that it reaches the communication port CN12, leaving some slack.
- Connect the Modbus RS485 communication cable to the GND, - and + pins of the CN12 connector.



NOTE: It is possible to replace the box-cable sheath junctions with \varnothing 25mm cable gland (not provided by the manufacturer).

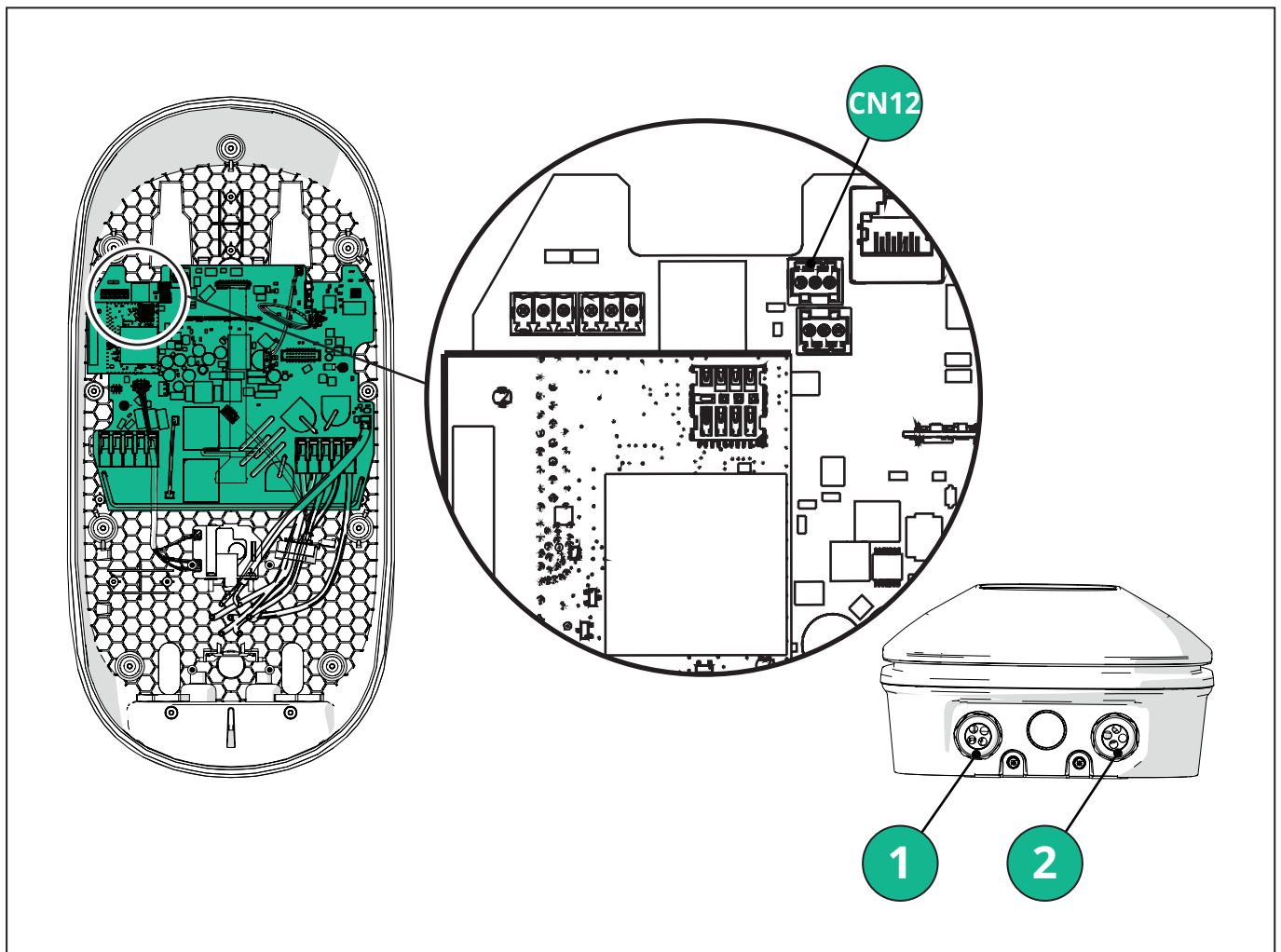

1 - Power supply cables

2 - Communication cables

CN12 - RS485 Modbus for external meter communication (**DPM** and **MID**)

Connect the communication cables in the following order from the **PowerMeter (DPM)** to **eLuxWallbox**.



WARNING: If the installation includes both accessories, follow the instructions for “MIDcounter and PowerMeter (DPM) combined installation”.

CN12	Finder 1ph 7M.24.8.230.0210
GND	SC
-	B
+	A

CN12	Gavazzi 3ph EM340DINAV23XS1PFB
GND	10
-	9
+	8

Junction 9/7

CN12	Finder 3ph 7M.38.8.400.0212
GND	SC
-	B
+	A

CN12	Gavazzi Ind 1ph EM111DINAV51XS1X / EM111DINMV51XS1X
GND	7
-	8
+	6

Junction 8/5

CN12	Gavazzi 1ph EM111DINAV81XS1PFB
GND	7
-	8
+	6

Junction 8/5

CN12	Gavazzi Ind 3ph EM330DINAV53HS1X
GND	13
-	12
+	11

Junction 12/10

3.4. MIDcounter and PowerMeter (DPM) combined installation

If installing both electrical accessories, the positioning of **MIDcounter** together with the **PowerMeter (DPM)** is indicated in the diagram below:

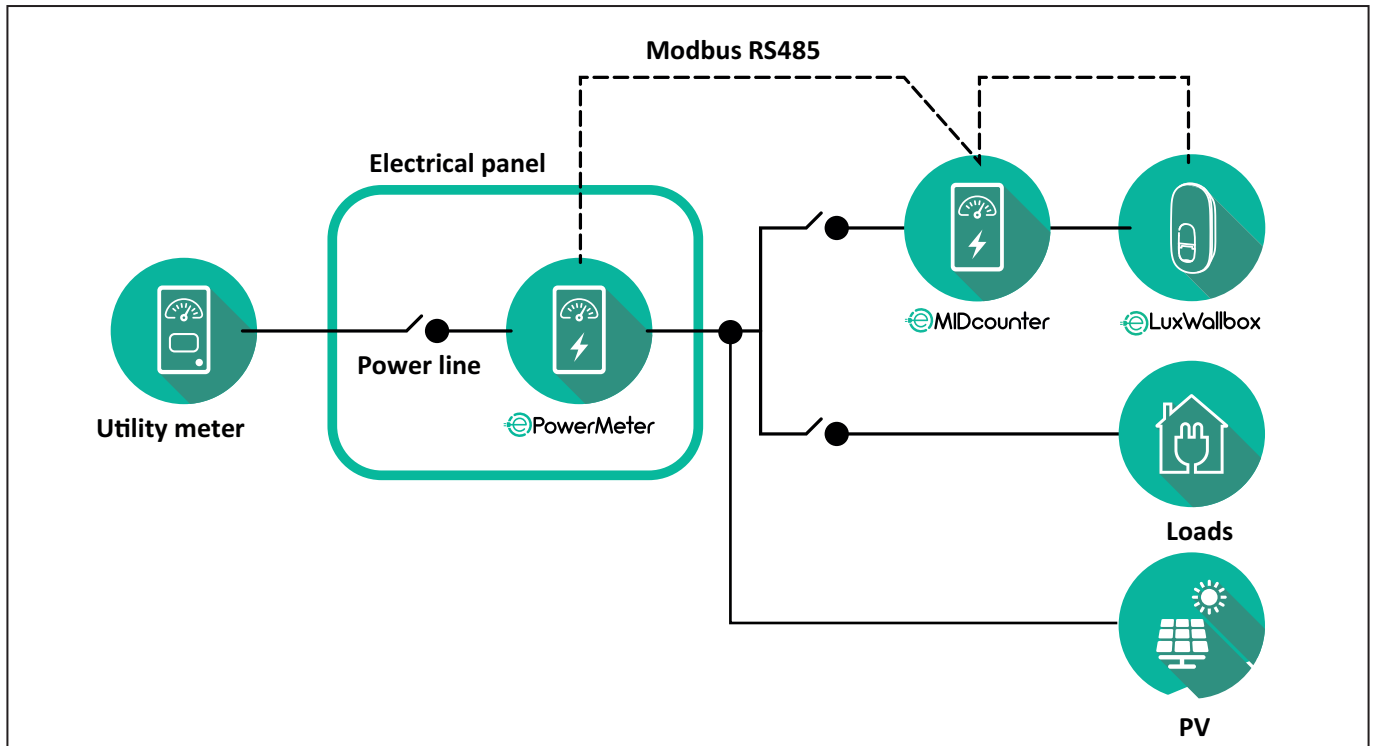

Connect the Modbus communication cables. The **PowerMeter (DPM)**, **MIDcounter** and the **eLuxWallbox** must be connected on the same communication bus in a Daisy chain format.

On the **eLuxWallbox**:

- Remove the protective cap of the communication cable entry point and insert the \varnothing 25 mm corrugated sheath.
- Tighten the box-cable sheath junction.
- Insert the communication cable, pulling it to a suitable length so that it reaches the communication port CN12, leaving some slack.
- Connect the Modbus RS485 communication cable to the GND, - and + pins of the CN12 connector.

Use the table below to connect the communication cables from the accessories to the **eLuxWallbox**.

Single-Phase.

PowerMeter (DPM)	MIDcounter	eLuxWallbox
EM111DINAV51XS1X - EM111DINMV51XS1X	EM111DINAV81XS1PFB	CN12
GND (7)	GND (7)	GND
A- (8) / T*(5)	A- (8)	-
B+ (6)	B+ (6)	+
EM111DINAV51XS1X - EM111DINMV51XS1X	7M 24.8.230.0210	CN12
GND (7)	SC	GND
A-(8) / T*(5)	B-	-
B+ (6)	A+	+
EM111DINAV81XS1PFB	EM111DINAV81XS1PFB	CN12
GND (7)	GND (7)	GND
A-(8) / T*(5)	A- (8)	-
B+ (6)	B+ (6)	+
EM111DINAV81XS1PFB	7M 24.8.230.0210	CN12
GND (7)	SC	GND
A-(8) / T*(5)	B-	-
B+ (6)	A+	+
7M 24.8.230.0210	EM111DINAV81XS1PFB	CN12
SC	GND (7)	GND
B-	A- (8)	-
A+	B+ (6)	+
7M 24.8.230.0210	7M 24.8.230.0210	CN12
SC	SC	GND
B-	B-	-
A+	A+	+

Three-Phase.

PowerMeter (DPM)	MIDcounter	eLuxWallbox
EM330DINAV53HS1X	EM340DINAV23XS1PFB	CN12
GND (13)	GND (10)	GND
A-(12) / T*(10)	A-(9)	-
B+ (11)	B+ (8)	+
EM330DINAV53HS1X	7M.38.8.400.0212	CN12
GND (13)	SC	GND
A-(12) / T*(10)	B-	-
B+ (11)	A+	+
EM340DINAV23XS1PFB	EM340DINAV23XS1PFB	CN12
GND (10)	GND (10)	GND
A-(9) / T*(7)	A-(9)	-
B+ (8)	B+ (8)	+
EM340DINAV23XS1PFB	7M.38.8.400.0212	CN12
GND (10)	SC	GND
A-(9) / T*(7)	B-	-
B+ (8)	A+	+
7M.38.8.400.0212	EM340DINAV23XS1PFB	CN12
SC	GND (10)	GND
B-	A-(9)	-
A+	B+ (8)	+
7M.38.8.400.0212	7M.38.8.400.0212	CN12
SC	SC	GND
B-	B-	-
A+	A+	+

*A 120 Ω terminating resistor must be installed on the devices at the ends of the Modbus chain. The resistor is present by default in the **eLuxWallbox**. Gavazzi models have a built-in resistor, which can be enabled by making a jumper between these terminals.

4. PowerMeter (DPM) and MIDcounter configuration

Power on the **PowerMeter (DPM)** and/or the **MIDcounter** when the electrical installation and communication installation are complete. Then proceed with the configuration on the display of the meters.

The configuration varies depending on the model.

4.1. Finder models

The following actions help to understand how to set Finder energy meters:

- Press the touchscreen button (a,b) to move between menus and parameters;
- Long press (~ 2 seconds) the touchscreen button (a,b) to enter and confirm selections

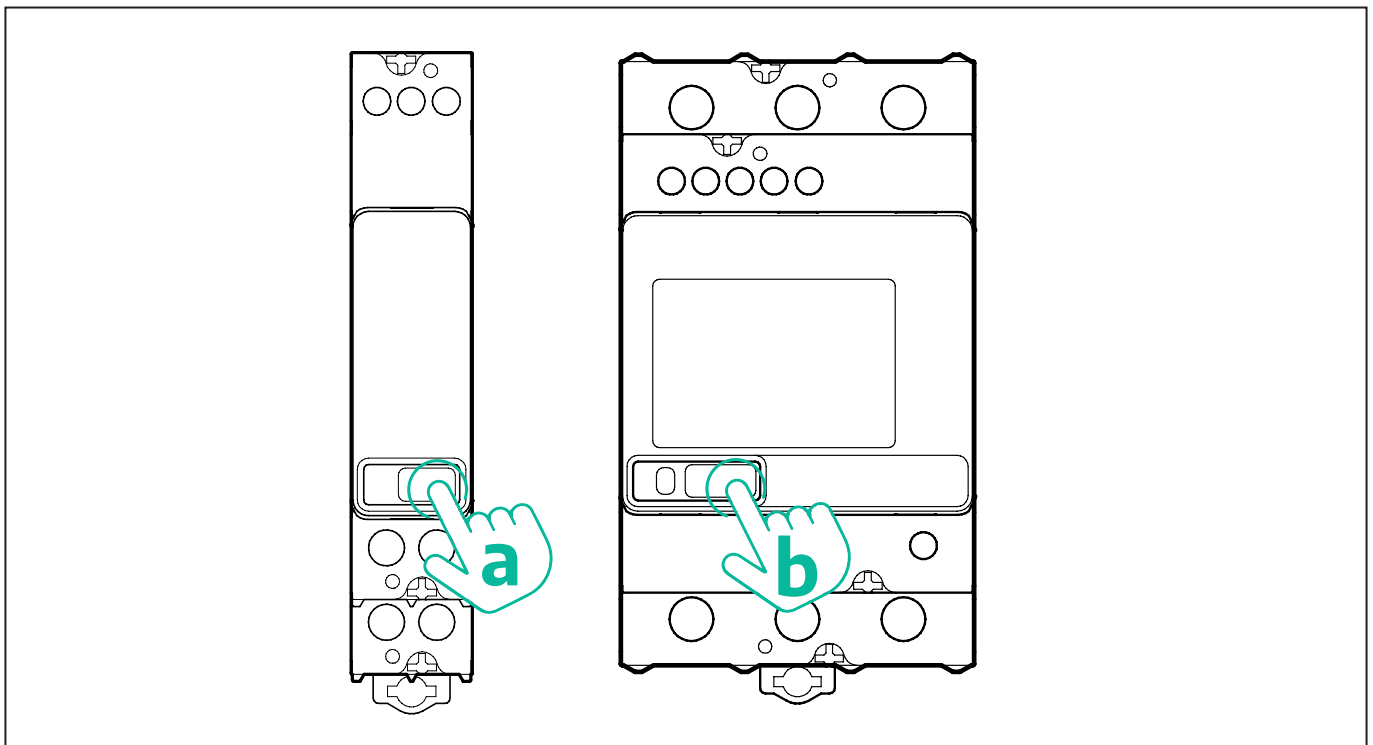

Follow the next steps to correctly configure the single-phase or three-phase Finder energy meters:

- When powering up the energy meter for the first time, long press the touchscreen button (a,b) until the display text blinks in order to enter the "MAIN" menu;
- Scroll the "MAIN" menu pressing the touchscreen button (a,b), then select "SETTING" ("SET" on single-phase meter). Long press to enter the selection.
- Scroll the "SETTING" menu pressing the touchscreen button (a,b), then select "COMMUNICATION" ("COMM" on single phase meter). Long press to enter the selection.
- Insert the correct values indicated in the table below. To modify the value press the touchscreen button (a,b), long press to confirm.

Only for three-phase Finder meter (in addition to previous options):

- Long press the touchscreen button (a,b) until the display text blinks in order to enter the "MAIN" menu (or return to the "MAIN" menu)
- Scroll the "MAIN" menu pressing the touchscreen button (a,b), then select "INSTALLATION". Long press the touchscreen button (a,b) to enter the selection
- Scroll the "INSTALLATION" menu pressing the touchscreen button (a,b) and then select the following option
 - "Communication mode" = "3L+N, L+N-Arithmetic"
 - Once the correct option is confirmed, enter the password: "DCBA" **Attention:** configuration cannot be modified after entering the password **DCBA**
 - Confirm the change selecting "Yes" when prompted.

ALL FINDER MODELS	PowerMeter (DPM)	MIDcounter
DEVICE ADDRESS	1	2
BITS PER SECOND (BAUD)	38400 bit/s	38400 bit/s
PARITY	Even	Even
STOP BIT	1	1
Additional for three-phase type		
	PowerMeter (DPM)	MIDcounter
COMMUNICATION MODE	3L+N, L+N-Arithmetic	3L+N, L+N-Arithmetic
PASSWORD	DCBA	DCBA

4.2. Gavazzi models

The following actions help to understand how to set Gavazzi energy meters:

- Press the touchscreen buttons (c, d, e, g) to move between menus and values
- press (~ 2 seconds) the touchscreen button (d, f) to enter the menu and confirm selections

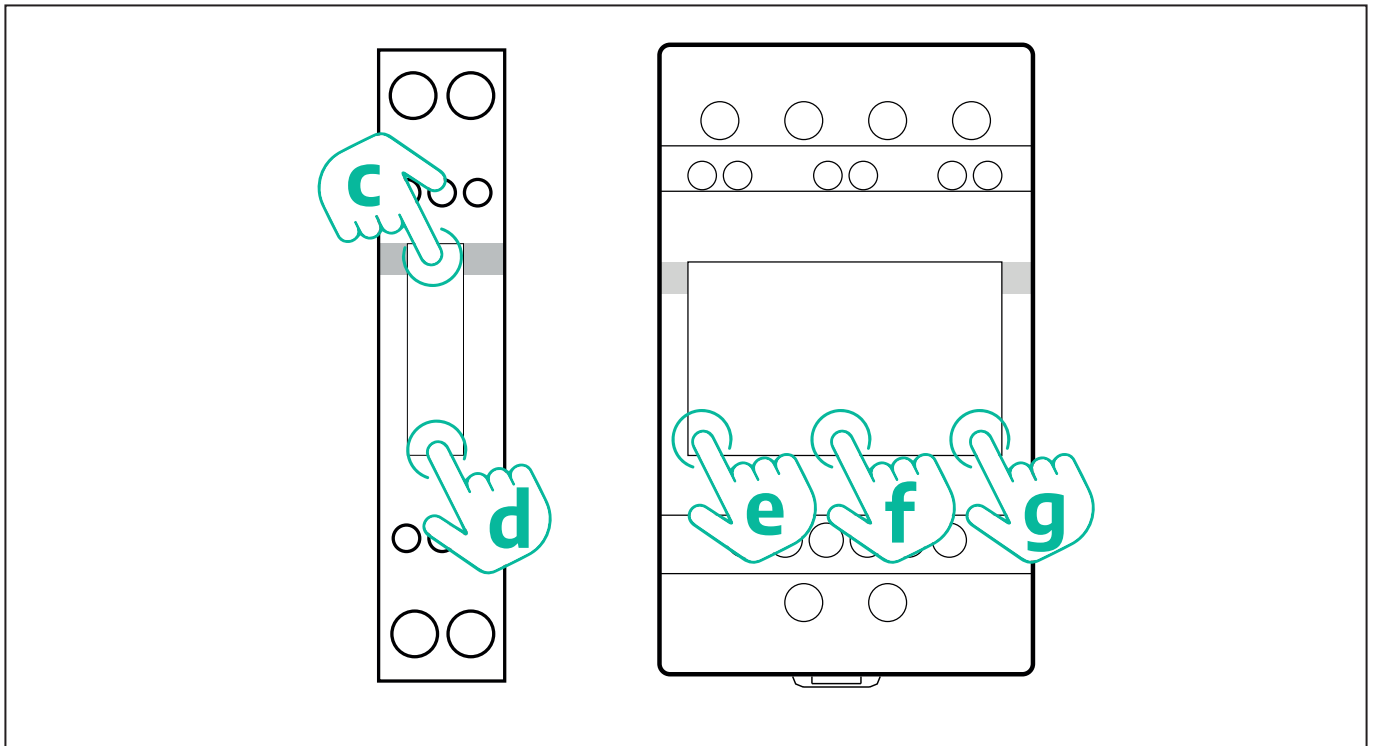

Follow the next steps to correctly configure the single-phase Gavazzi direct and indirect energy meters.

- When powering up the energy meter for the first time, long press the touchscreen button (d) until the password appears on the screen
- Long press the buttons (c, d) simultaneously in order to confirm the password "0000" and enter the "MAIN" menu
- Scroll the "MAIN" menu pressing the upper button (c) and then select the following options in the table below

Follow the next steps to correctly configure the three-phase Gavazzi direct and indirect energy meters:

- When powering up the energy meter for the first time, long press the central button (f) until the password appears on the screen;
- Long press the buttons (e, g) simultaneously in order to confirm the password "0000" and enter the "MAIN" menu
- Scroll the "MAIN" menu pressing the buttons (e or g) and then select the options in the table below

ALL GAVAZZI MODELS	PowerMeter (DPM)	MIDcounter
PASS	0000	0000
ADDRESS	001	002
BAUD	38.4	38.4
PARITY	Even	Even
Additional for three-phase type		
	PowerMeter (DPM)	MIDcounter
SYSTEM	3Pn	3Pn
ADDRESS	001	002

4.3. Device configuration summary

EM340DINAV23XS1PFB / EM330DINAV53HS1X		EM340DINAV23XS1PFB	
PASS	0000	PASS	0000
SYSTEM	3Pn	SYSTEM	3Pn
ADDRESS	1	ADDRESS	2
BAUD	38.4	BAUD	38.4
PARITY	EVEN	PARITY	EVEN

EM111DINAV81XS1PFB / EM111DINAV51XS1X / EM111DINMV51XS1X		EM111DINAV81XS1PFB	
PASS	0000	PASS	0000
ADDRESS	001	ADDRESS	002
BAUD	38.4	BAUD	38.4
PARITY	EVEN	PARITY	EVEN

7M 24.8.230.0210		7M 24.8.230.0210	
DEVICE ADDRESS	__ 1	DEVICE ADDRESS	__ 2
BITS PER SECOND (BAUD)	38400 bit/s	BITS PER SECOND (BAUD)	38400 bit/s
PARITY	EVEN	PARITY	EVEN
STOP BIT	1	STOP BIT	1

7M.38.8.400.0212		7M.38.8.400.0212	
DEVICE ADDRESS	__ 1	DEVICE ADDRESS	__ 2
BITS PER SECOND (BAUD)	38400 bit/s	BITS PER SECOND (BAUD)	38400 bit/s
PARITY	EVEN	PARITY	EVEN
STOP BIT	1	STOP BIT	1
CONNECTION MODE	3L+N, L+N - Arithmetic	CONNECTION MODE	3L+N, L+N - Arithmetic
PASSWORD	DCBA	PASSWORD	DCBA

4.4. PowerMeter (DPM) and MIDcounter configuration on APP

To complete installation, the final configuration of the **eLuxWallbox** and its accessories should be set via the dedicated app

PowerUp is a smartphone app for qualified installers only, available via Google Play™ and Apple Store®. The configuration is carried out via a Bluetooth connection. The wallbox cannot operate correctly if not configured via the app.



NOTICE: Make sure you have the latest version of PowerUp to have access to all of the features.

Follow the instructions below to get started with the app:

Download PowerUp to your smartphone and activate Bluetooth on the smartphone.



Scan **eLuxWallbox** QR code to pair it with the app. The QR Code can be found on the side of the charger.

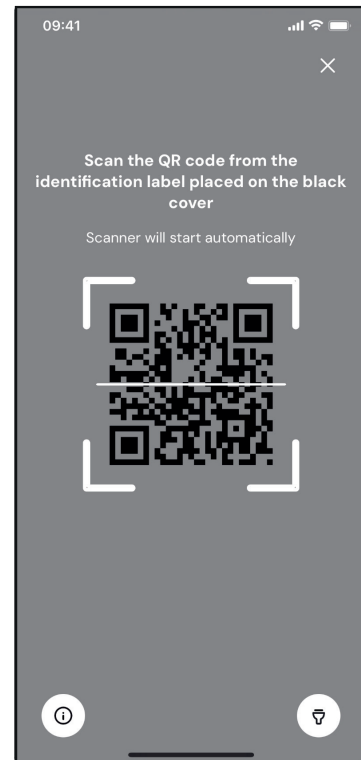

Once paired, complete the configuration set up of **eLuxWallbox** and its Accessories by clicking on the parameter to be configured.

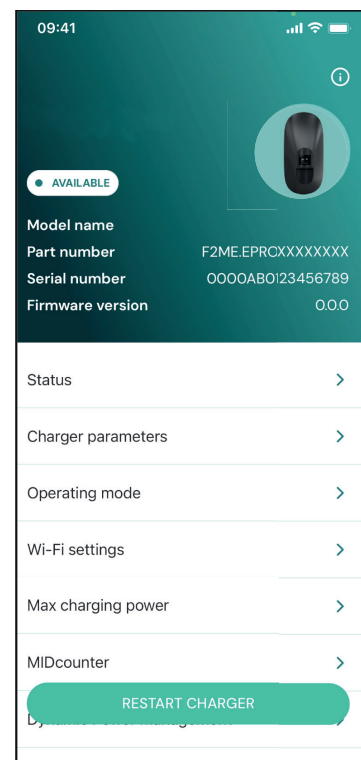

4.5. PowerMeter (DPM) configuration

To complete installation of the **PowerMeter (DPM)**, follow the steps below:

Select "**DPM PowerMeter**" on the homepage

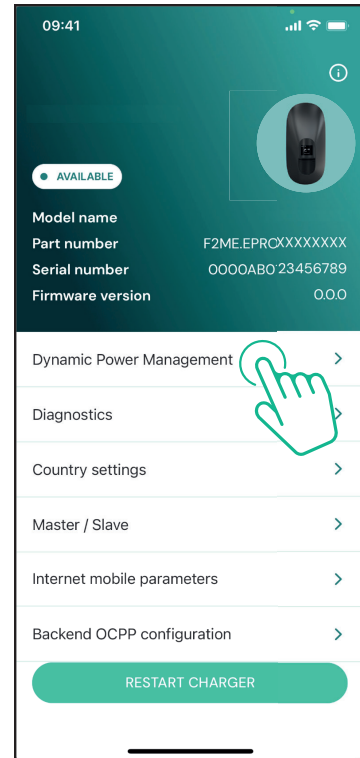

Select the **PowerMeter** type from the drop-down menu, matching the model installed.

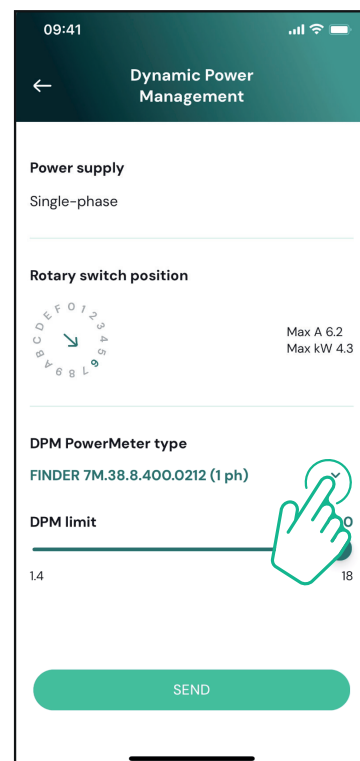

Enter the value of the user contractual power as **DPM** power limit.

For Indirect Meter only - Set the CT current ratio with the slider.

- With CTV 60 A set 60 as Current ratio
- With CTA 100 A set 20 as Current ratio
- With CTA 150 A set 30 as Current ratio

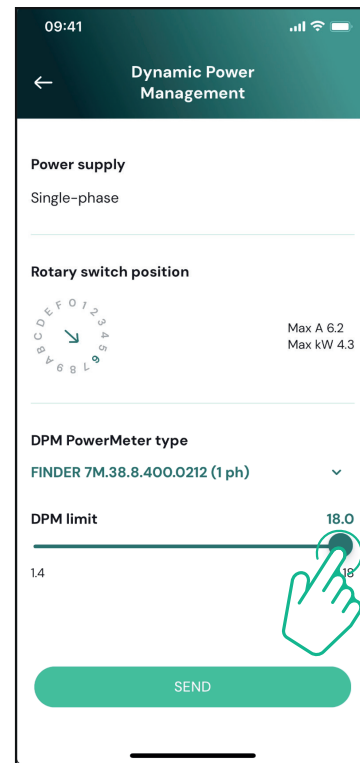

Click "Send" and confirm on the pop-up to restart **eLuxWallbox**.

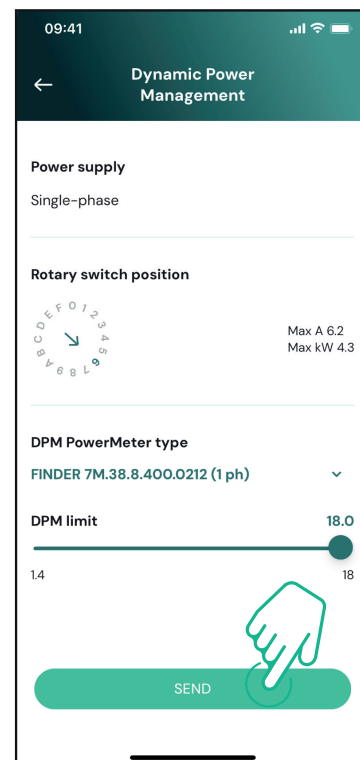

4.6. MIDcounter configuration

To complete installation of the **MIDcounter**, follow the steps below:

Select "**MIDcounter**" on the homepage

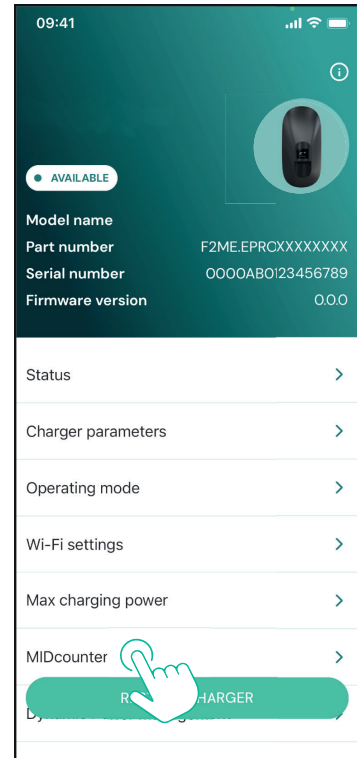

Select the **MIDcounter** type from the drop down menu, based on the model installed.

Select "OFF" from the drop down menu to disable the **MIDcounter** configuration.

Click "Send" to confirm.

To make the changes effective, click on the back arrow in the top left corner and restart **eLuxWallbox** through the dedicated button in the homepage.

If the installation has both the **PowerMeter (DPM)** and the **MIDcounter** it is possible to proceed with **DPM** configuration before restarting.

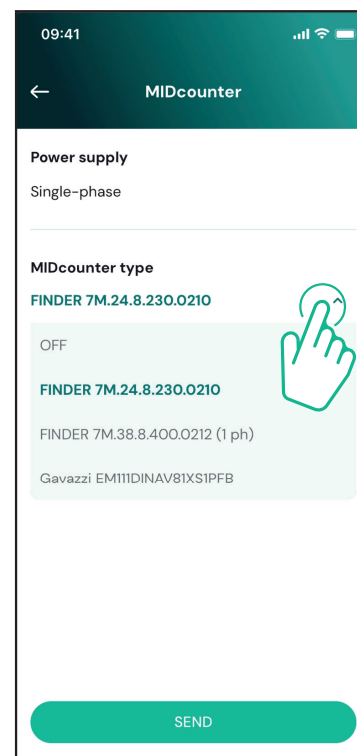

5. TROUBLESHOOTING

Error conditions are stored in the diagnostic logs and shown on the charger panel:

- On the **eLuxWallbox Move** model, the LED bar blinks red. See the **Diagnostic** section of PowerUP or the end-user App for the detailed error code.
- On the **eLuxWallbox** model, the display shows the error code, which is also available in the **Diagnostic** section of PowerUP.

When an error occurs, the charge is interrupted, and the socket is unlocked to allow you to disconnect the plug.

The following table provides a list of errors that can occur and the relative troubleshooting. If the error persists, note the serial number on the charger label and contact Customer Service.

Error code / issue	"Error Description"	Troubleshooting
100	Lack of power supply	<p>Check if the circuit breaker is ON. Check that the CN1 cabling is correct. Check the voltage in CN1.</p>
101	Overheating	<p>Disconnect the Type 2 cable, wait for the temperature to drop, then the error will clear.</p> <p>To restart the charging session, plug in the cable again. Make sure that installation site is compatible with temperature range (25°C/+50°C without direct exposure to sunlight)</p>
102	Communication error between MCU and MPU.	<p>Restart the charger from the circuit breaker, leaving the charger switched off for at least 60 seconds.</p>
103	Hardware fault, ground protection device error (GPD error)	<p>Check the cabling on CN1:</p> <ul style="list-style-type: none"> - in single-phase, make sure that ground cable is connected to PE, the Neutral cable is connected to N and the phase cable to T - in three-phase, make sure that the ground cable is connected to PE, the Neutral cable is connected to N and the phase cables L1, L2 and L3 are connected to T, S, and R. <p>Check whether the voltage difference between PE and N does not exceed 10V. Check PE connection</p> <p>If all connections are checked and the error persists, open the charger and modify the configuration of the Dipswitch (SW2) connector.</p>

104	Hardware fault, residual current monitor AC error. (RCM AC trip)	<p>Try to start a new charging session, removing and plugging in all the connectors.</p> <p>If the problem persists, check for the presence of any problems in the charging cable or vehicle inlet.</p> <p>If the cables and the EV don't show any problem, check CN27 connector and RCM cable.</p>
105	Hardware fault, residual current monitor DC error. (RCM DC trip)	<p>Check that the problem is not with the cable or vehicle. If possible, try another charging session with a different cable or vehicle.</p>
106	Internal meter error	<p>Restart the charger from the circuit breaker, leaving the charger switched off for at least 60 seconds.</p>
107	PowerMeter (DPM) communication error	<p>Check that the communication configuration on the DPM PowerMeter device is correct.</p> <p>Check that the DPM model configuration in the installer App is correct.</p> <p>Check the communication cable wiring on CN12.</p> <p>Check that the communication cable used is suitable for Modbus RS485 and cable length.</p>
108	Configuration Error, Rotary switch position (supply type) is not consistent with the DPM/ MID type.	<p>Check the position of the rotary switch. If it is not consistent with the 1-ph/3-ph installation, change it according to the table in the manual, then restart the charger.</p> <p>If the accessories (DPM/MID) are not installed, make sure that the function is disabled in the installer App.</p> <p>If the accessories (DPM/MID) are installed, check that the correct model is selected on the installer App. Then restart the charger.</p>
109	Main/secondary RS485 communication error	<p>Check the configuration of the Main/Secondary set up from installer App.</p> <p>Check that the Main charger is available.</p> <p>Check that the wiring of the communication cable on CN9 and CN10 is correct.</p> <p>Check that the communication cable used is suitable for Modbus RS485.</p>

110	MIDcounter communication error	<p>Check that the communication configuration on the MIDcounter device is correct.</p> <p>Check the communication cable wiring on CN12.</p> <p>Check that the communication cable used is suitable for Modbus RS485.</p> <p>Check that the MID model configuration in the installer App is correct.</p>
300	Inconsistency between the charger contactor command and feedback	<p>Restart the charger from the circuit breaker, leaving the charger switched off for at least 60 seconds.</p> <p>If error persists even after restart, call Customer Service.</p>
301	Short circuit detected on the Control Pilot line.	<p>With the charger switched off, check that there is no damage and no defects inside and outside the socket (if so, avoid using the charger and contact Customer Service).</p> <p>Check that the problem is not related to the cable or vehicle and try another charge session (with another vehicle or cable if possible).</p>
302	State E or F set on the Control Pilot line.	<p>With the charger switched off, check that there is no damage and no defects inside and outside the cable and its connectors (if so, avoid using it and attempt charge with another cable).</p>
303	Control Pilot disconnected.	<p>Check that the cable connectors are fully inserted inside the charger socket and vehicle inlet.</p>
304	Proximity Pilot disconnected.	<p>Check that the problem is not related to the cable or vehicle and try another charge session (with another vehicle or cable if possible).</p>
305	Broken Proximity Pilot detected.	<p>Check that the problem is not related to the cable or vehicle and try another charge session (with another vehicle or cable if possible).</p>
306	Diode fault detected on Control Pilot line (no - 12V).	<p>Attempt a new charging session unplugging and reinserting the cable from both the charger and vehicle inlet.</p>
307	Control Pilot disconnected.	<p>With the charger switched off, check that there is no damage and no defects inside and outside the cable and its connectors (if so, avoid using it and attempt charge with another cable).</p> <p>Check that the cable connectors are fully inserted inside the charger socket and vehicle inlet.</p> <p>Check that the problem is not related to the cable or vehicle and try another charge session (with another vehicle or cable if possible).</p>

308	Inconsistency between the motor command and feedback, or the motor is in an error condition.	<p>Attempt a new charging session unplugging and reinserting the cable from both the charger and vehicle inlet.</p> <p>Check that the cable connectors are fully inserted inside the charger socket and vehicle inlet.</p>
309	Motor check error during EVSE initialization phase.	Restart the charger from the circuit breaker, leaving the charger switched off for at least 60 seconds.
310	Error detected before charging (PP not detected, or motor fault, or CP not detected).	<p>With the charger switched off, check that there is no damage and no defects inside and outside the cable and its connectors (if so, avoid using it and attempt charge with another cable).</p> <p>Check that the cable connectors are fully inserted inside the charger socket and vehicle inlet.</p>
311	Error detected after charging (motor fault, or CP not disconnected).	Check that the problem is not related to the cable or vehicle and try another charge session (with another vehicle or cable if possible).
312	Emergency stop received from the MPU.	Restart the charger from the circuit breaker, leaving the charger switched off for at least 60 seconds.
313	Current detected during charging, with 100% duty cycle on the Control Pilot line.	Check that the problem is not cable nor vehicle related, attempt a new charging session with another cable and/or charger.
315	Current over limits on phase L1	Unplug the cable, if possible lower the power of charge on the vehicle side and attempt a new charging session.
316	Current over limits on phase L2	
317	Current over limits on phase L3	
318	Voltage below a threshold on phase L1	<p>Check the rotary switch position is consistent with 1-ph/3-ph installation.</p> <p>Check that the voltage on CN1-T is above 196 V.</p> <p>If the voltage is below 196 V, check the electric system or contact the energy supplier.</p> <p>If an error occurs during vehicle charging, try to reduce the set-up charging power and verify that the electric system is correctly dimensioned for the power drawn by the vehicle.</p>

319	Voltage below a threshold on phase L2	The rotary switch is in a three-phase position. Check that the intended installation is in three-phase. If not, select the correct rotary switch position as per Installation Manual.
320	Voltage below a threshold on phase L3	<p>Check that the voltage on CN1-S and R is above 196 V. If the voltage is below 196V, check the electric system or contact the energy supplier.</p> <p>If an error occurs during vehicle charging, try to reduce the set-up charging power and verify that the electric system is correctly dimensioned for the power drawn by the vehicle.</p>
321	Forbidden state change (IEC 61851-1)	<p>EV does not meet IEC 61851-1 standards for starting a charge session.</p> <p>Attempt a new charging session unplugging and reinserting the cable from both the charger and vehicle inlet.</p> <p>If the error persists, contact the vehicle manufacturer.</p>
	Display/LED stuck in Welcome mode (LED blinks red-green-blue)	Restart the charger from the circuit breaker, leaving the charger switched off for at least 60 seconds.
	LED or display does not light up at startup	
	The charger does not start	<p>Let the unit restart, it may take up to 30 seconds.</p> <p>Check if the circuit breaker is ON.</p> <p>Check that the CN1 cabling is correct.</p> <p>Check the voltage in CN1.</p> <p>Restart the charger from the circuit breaker, leaving the charger switched off for at least 60 seconds.</p>
	Cable stuck in the charger socket	Turn off the charger from the circuit breaker, then remove the cable.
	Suspended Charging with solid green LED/ message on the display. The charging session is suspended by the DPM or the EV. The session may resume.	<p>Verify that the max power in the DPM power limit section of the installer App is consistent with the contract power value in kW as indicated in the user's electricity contract. If the value is correct, wait for the charging session to resume or turn off some house loads.</p> <p>In the case of 3-ph installation, verify that the electrical loads are well balanced on the phases of the domestic system.</p>

	<p>App pairing does not complete after QR scan.</p>	<p>Check the integrity of the QR code on the label. Update the App to the latest version. Close and restart the App, then try again. Restart the charger from the circuit breaker, leaving the charger switched off for at least 60 seconds.</p>
--	---	---

6. CLEANING

Cleaning the outside of the device is always recommended when necessary and should be carried out using a soft damp cloth with a mild detergent. When finished, wipe off any traces of moisture or liquid with a soft dry cloth.



CAUTION: Avoid strong jets of air or water as well as the use of soaps or detergents that are too harsh and corrosive for the materials of the charger.

7. PACKAGING DISPOSAL



Dispose of packaging in an environmentally friendly manner. The materials used for packaging this product can be recycled and must be disposed of in compliance with the legislation in force in the country of use. The following disposal directions will be found on the packaging based on the type of material.



NOTE: Further information about current disposal facilities can be obtained from local authorities.

8. ASSISTANCE

If you have any questions about the installation of **eLuxWallbox**. For any other information or requests for support, please contact Free2move eSolutions S.p.A. through the relevant section of its website: www.esolutions.free2move.com.

9. DISCLAIMER

Free2move eSolutions S.p.A. will not be held responsible for any damage directly or indirectly caused to people, things or animals due to the failure to comply with all the provisions set out in this Manual, and the warnings regarding the installation and maintenance of **eLuxWallbox**.

Free2move eSolutions S.p.A. reserves all rights to this document, the article and the illustrations it contains. The reproduction, whole or in part, disclosure to third parties or use of its contents is prohibited without the prior written consent of Free2move eSolutions S.p.A.

Any information in this manual may be changed without prior notice and does not represent any obligation on the part of the manufacturer. Images in this manual are for illustrative purposes only and might differ from the delivered product.

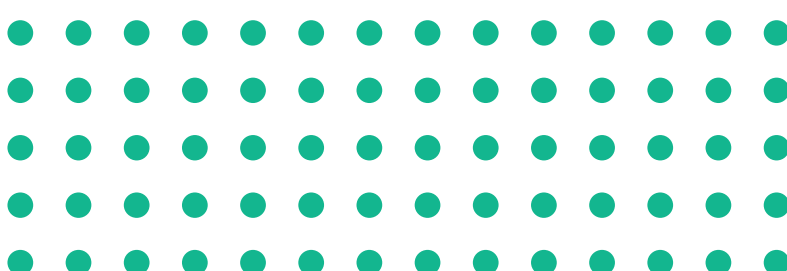

Registered office
Free2move eSolutions S.p.A.
Piazzale Lodi, 3
20137 Milan - Italy
www.esolutions.free2move.com

EN

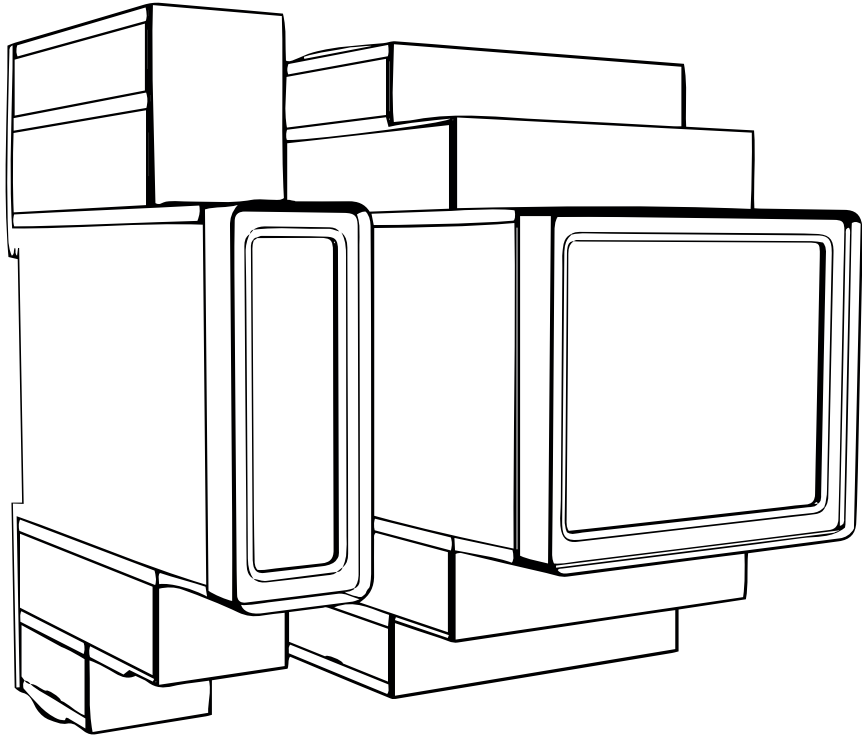
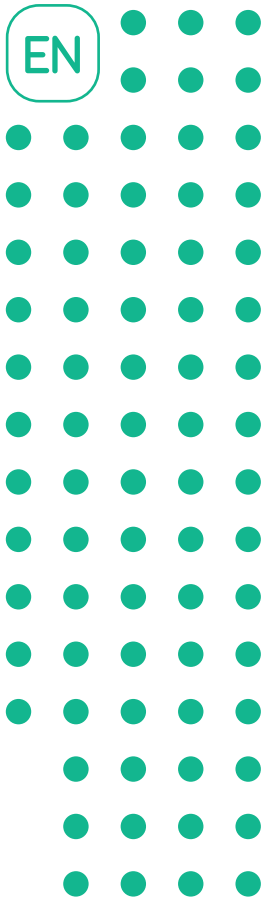

LuxWallbox

Accessories Manual



For safe and proper use,
follow these instructions.
Keep them for future reference

Table of content

1. INTRODUCTION	4
1.1. Purpose of the Manual	4
1.2. Identification of the Manufacturer.....	4
1.3. Structure of the Accessories Manual	4
1.4. Safety	5
1.5. Personal Protective Equipment (PPE).....	6
1.6. Warranty and delivery conditions	6
1.7. List of documents.....	7
1.8. Warnings	7
2. GENERAL INFORMATION	8
2.1. Fields of use	9
3. ACCESSORIES INSTALLATION	10
3.1. Installing PowerMeter (DPM).....	10
3.2. Installing MIDcounter	15
3.3. Communication cable installation	17
3.4. MIDcounter and PowerMeter (DPM) combined installation .	19
4. PowerMeter (DPM) and MIDcounter configuration.	22
4.1. Finder models.....	22
4.2. Gavazzi models.....	24
4.3. Device configuration summary	25
4.4. PowerMeter (DPM) and MIDcounter configuration on APP ..	26
4.5. PowerMeter (DPM) configuration	28
4.6. MIDcounter configuration.....	30
5. TROUBLESHOOTING.....	31
6. CLEANING.....	36
7. PACKAGING DISPOSAL	36
8. ASSISTANCE.....	37
9. DISCLAIMER.....	37



1. INTRODUCTION

1.1. Purpose of the Manual

This installation manual is a guide to help operators to work safely and carry out the installation operations needed to keep the charger in good working order.

The purpose of this document is to support qualified technicians who have received appropriate training, and demonstrated suitable skills and knowledge in the construction, installation, operation and maintenance of electrical equipment.

If the charger is used in a manner not specified in this manual, the protection provided by the charger may be impaired. This document contains the information required for the installation of the charger.

This document has been carefully checked by the Manufacturer Free2move eSolutions S.p.A. but oversights cannot be completely ruled out. If any errors are noted, please inform Free2move eSolutions S.p.A. Except for explicit contractual obligations, under no circumstances may Free2move eSolutions S.p.A. be held liable for any loss or damage resulting from the use of this manual, or from installation of the equipment. This document was originally written in English. In the event of any inconsistencies or doubts, please ask Free2move eSolutions S.p.A. for the original document.

1.2. Identification of the Manufacturer

The manufacturer of the charger is:

Free2move eSolutions S.p.A.

Piazzale Lodi, 3

20137 Milan – Italy

www.esolutions.free2move.com

1.3. Structure of the Accessories Manual

This manual is divided into chapters based on different topics and containing all the information that is needed to install the charger safely.

Each chapter is sub-divided into paragraphs which examine the fundamental points, and each paragraph may have its own title, along with sub-titles and a description.

1.4. Safety

This manual contains important safety instructions that must be followed during installation of the charger.

In order to fulfil this objective, this manual contains a number of precautionary texts, containing special instructions. These instructions are highlighted by a specific text box and are accompanied by a symbol, and are provided in order to ensure the safety of the personnel required to perform the operations described, and to avoid any damage to the charger and/or property:

	<p>This symbol means: DANGER</p> <p>This symbol is intended to highlight a dangerous situation for yourself and others. Read it carefully. Failure to comply with the instruction will result in an imminent hazardous situation which, if not avoided, will result in instant death, or serious or permanent injury.</p>
---	--

	<p>This symbol means: WARNING</p> <p>This symbol is intended to highlight safety information. Failure to comply with the instruction will result in a potentially hazardous situation which, if not avoided, could result in death or serious injury.</p>
---	--

	<p>This symbol means: CAUTION</p> <p>This symbol is intended to highlight safety information. Read it carefully. Failure to follow these instructions can result in death, serious injury or damage to equipment.</p>
---	--

	<p>This symbol means: NOTE</p> <p>Provides additional information to supplement instructions provided.</p>
---	---

	<p>This symbol means: NOTICE</p> <p>Provides instructions concerning the use of conduct necessary to handle the operations not associated with possible physical injuries.</p>
---	---

Installation must be carried out by qualified personnel. A dedicated, state-of-the-art electricity supply system must be designed and installed, and the system must be certified in compliance with local regulations and the energy supply contract.

Operators are required to read and fully understand this manual, and to comply strictly with the instructions it contains.

Free2move eSolutions S.p.A. cannot be held liable for damage caused to persons and/ or property, or to the equipment, if the conditions described in this document have not been complied with.





WARNING: Installation must be carried out in accordance with the regulations in force in the country of installation, and in compliance with all safety regulations for carrying out electrical work.

1.5. Personal Protective Equipment (PPE)

Personal Protective Equipment (PPE) means any equipment intended to be worn by the workers in order to protect them against one or more hazards likely to threaten their health or safety at the workplace, as well as any device or accessory intended for this purpose.

Since all the PPE indicated in this manual is intended to protect the personnel against health and safety hazards, the Manufacturer of the charger which is the subject of this manual recommends strict compliance with the indications contained in the various sections of this manual.

The list of PPE to be used in order to protect the operators against the residual risks present during the installation and maintenance interventions described in this document is provided below.

Symbol	Meaning
	Wear protective gloves
	Wear anti-static footwear



WARNING: It is responsibility of the operator to read and understand local regulations and evaluate the environmental conditions of the installation site in order to comply the need to wear additional PPE.

1.6. Warranty and delivery conditions

The warranty details are described in the Terms and Conditions of Sale included with the purchase order for this product and/or in the packaging of the product.

Free2move eSolutions S.p.A. assumes no responsibility for failure to comply with the instructions for proper installation, and cannot be held responsible for systems upstream or downstream of the equipment supplied.

Free2move eSolutions S.p.A. cannot be held responsible for defects or malfunctions deriving from: improper use of the charger; deterioration due to transport or particular environmental conditions or installation by unqualified persons.

Free2move eSolutions S.p.A. is not responsible for any disposal of the equipment, or parts thereof, that does not comply with the regulations and laws in force in the country of installation.



NOTICE: Any modification, manipulation or alteration of the hardware or software not expressly agreed with the manufacturer will immediately void the warranty.

1.7. List of documents

In addition to this manual, product documentation can be viewed and downloaded by visiting: www.esolutions.free2move.com.

1.8. Warnings



DANGER: Risk of electric shock and fire. Installation must be carried out in accordance with the regulations in force in the country of installation, and in compliance with all safety regulations for carrying out electrical work.

- Before installing or using the device, make sure that none of the components have been damaged. Damaged components can lead to electrocution, short circuits, and fire due to overheating. A device with damage or defects must not be used.
- Install **eLuxWallbox** away from petrol cans or combustible substances in general.
- Before installing **eLuxWallbox compatible accessories**, ensure the main power source has been disconnected.
- The **eLuxWallbox compatible accessories** must only be used for the specific applications they are designed for.
- Installation not carried out correctly may pose risks to the user.
- The charger must be connected to a mains network in compliance with local and international standards, and all the technical requirements indicated in this manual.
- Children or other persons not able to gauge risks related to the installation of the charger could suffer serious injury or put their lives at risk.
- Pets or other animals must be kept away from the device and packaging material
- Children must not play with the device, accessories or packaging provided with the product.
- The only part that can be removed from **eLuxWallbox**, is the removable cover. Access under the cover is only permitted by qualified personnel during installation, dismantling or maintenance.
- **eLuxWallbox** can only be used with an energy source.
- Necessary precautions to ensure safe operation with Active Implantable Medical Devices must be taken. To determine whether the charging process could adversely affect the medical device, please contact its manufacturer.

2. GENERAL INFORMATION

eLuxWallbox is an Alternate Current charging solution for powering electric vehicles and hybrid plug-ins, and is ideal for semi-public and residential use. The charger is available in three-phase or single-phase configurations and is equipped with a Type 2 socket.

The charger charges electric vehicles up to 22 kW in three-phase, or up to 7.4 kW in single-phase. The charger includes connectivity options such as remote monitoring via the eSolutions control platform (CPMS). Its final configuration must be completed using the **PowerUp** application. For the end user, the **eLuxWallbox** can be managed via the dedicated user's eSolutions Charging App. Both applications are available on Google Play™ and Apple Store®.

This charger is equipped with a SIM card for connection to the 4G mobile network.

The SIM card is automatically activated the first time the charger is turned on.

This document describes how to install the external accessories compatible with the **eLuxWallbox**.

The external accessories described in this manual are:

- **PowerMeter (DPM)**: an energy meter that enables the Dynamic Power Management (**DPM**) which is a smart function that allows an electric vehicle to be recharged using only the power available at home, modulating the charging power and avoiding unpleasant blackouts.
- **MIDcounter**: a certified energy meter that allows to monitor the consumption of the **eLuxWallbox** during each charging session.

This manual contains a description of the characteristics of the different accessories, information on models, installation process and final configuration of the devices.

The **eLuxWallbox** is configured to be used with the following electrical accessories: **PowerMeter (DPM)** or **MIDcounter**:

- Gavazzi, 1-phase, Direct, 32 A
- Finder, 1-phase, Direct, 40 A
- Gavazzi, 3-phase, Direct, 65 A
- Finder, 3-phase, Direct, 80 A

PowerMeter (DPM):

- Gavazzi, 1-phase, Indirect with 1x CT 100 A
- Gavazzi, 1-phase, Indirect with 1x CTV 60 A
- Gavazzi, 3-phase, Indirect with 3x CT 150 A



WARNING: Do not try to install the Electrical Accessories if you are not qualified as a professional electrician. To do so could cause serious danger and harm to you and to the people, property or animals around you.

To complete the installation, it is necessary to configure the **eLuxWallbox** through the dedicated apps:

	Installer's app: PowerUp
Product versions (EU):	EPRO23S224GWBAX
Product versions (UK):	EPRO23S224GWBAS



WARNING: Only Electrical Accessories suggested by Free2move eSolutions S.p.A. are compatible. Installation must be performed by qualified personnel in accordance with local regulations.

2.1. Fields of use

Free2move eSolutions S.p.A. declines all liability for any damage whatsoever due to incorrect or careless actions.

The charger may not be used for any purpose other than the one it is intended to fulfill.

The equipment must not be used by children or people with limited mental or physical abilities, or even by adults or expert professionals if the charger undergoes operations that do not comply with this manual and accompanying documentation.

The charger is a charging device for electric vehicles; the following classification (according to IEC 61851-1) identifies its characteristics:

- Power supply: permanently connected to the AC power supply grid
- Output: Alternate Current
- Environmental conditions: indoor / outdoor use
- Fixed installation
- Protection against electric shock: Class I
- EMC Environment classification: Class B
- Charging type: Mode 3 according to the IEC 61851-1 standard
- Optional function for ventilation not supported

3. ACCESSORIES INSTALLATION

To install the electrical accessories, it is necessary to use Modbus communication cables with the following characteristics:

- Modbus RS485 twisted STP 2x2 AWG24 or S/FTP cat.7 suitable for installation with a 400V power line
- Conductor size: 0.5 mm²
- Stripping length: 10 mm
- Recommended maximum length: 150 m

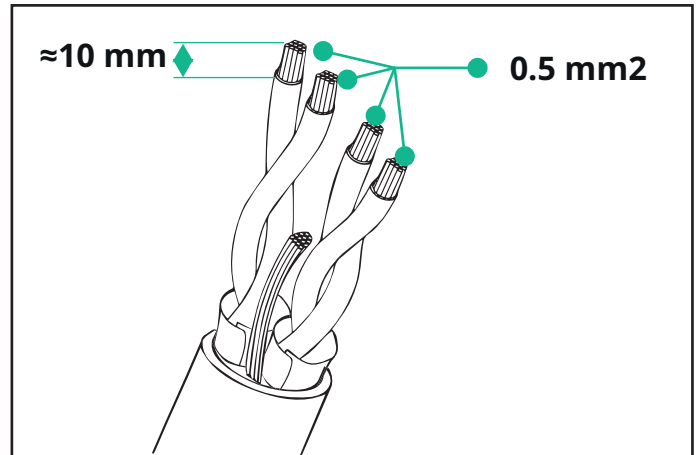

3.1. Installing PowerMeter (DPM)

PowerMeter (DPM) is an energy meter that enables the Dynamic Power Management (**DPM**) which is a smart function that allows an electric vehicle to be recharged using only the power available at home, modulating the charging power and avoiding unpleasant blackouts. Whenever other appliances are being used during the charging session, the system can modulate the charging power towards the car, even temporarily suspending the charging session. As soon as the other domestic appliances are switched off, the session will resume.

The **DPM** smart logic works both in three-phase and in single-phase installations.



WARNING: When installing in three-phase systems, make sure that the electrical loads (including the wallbox) are well balanced between the phases of the electrical system.



WARNING: Before carrying out any installation or maintenance work on the device, it must be ensured that the power supply is switched off.

For Direct models of the PowerMeter (DPM):

Place the **PowerMeter (DPM)** after the main utility meter. The **PowerMeter (DPM)** must measure all the electrical loads, including the **eLuxWallbox**.

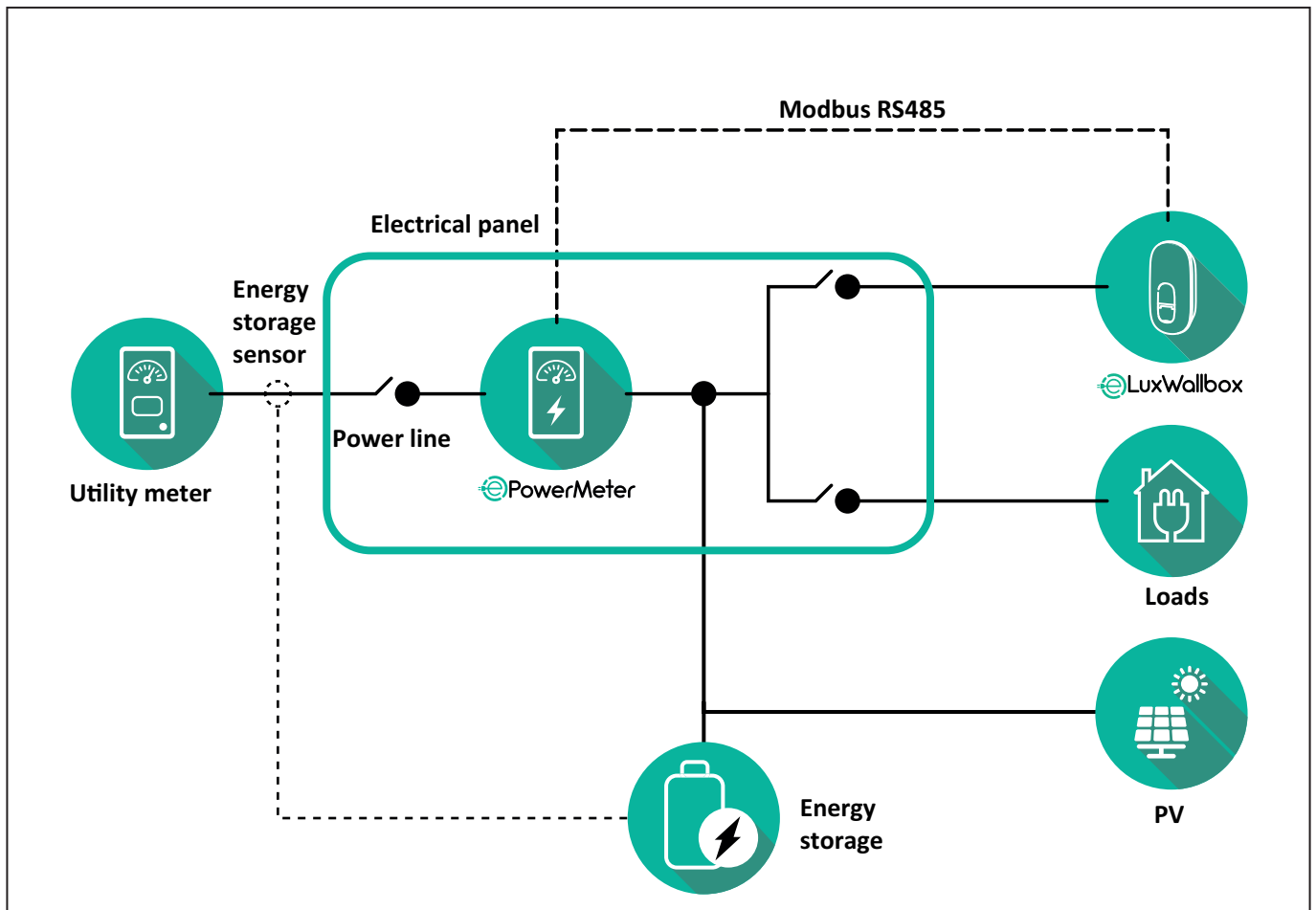

For Direct models of the PowerMeter:



WARNING: During the installation always refer to the manufacturer installation manual provided with the meter.



NOTE: For the single-phase or three-phase electrical connection of the Direct **PowerMeter**, please refer to the diagrams below.

Finder model 1ph and 3ph

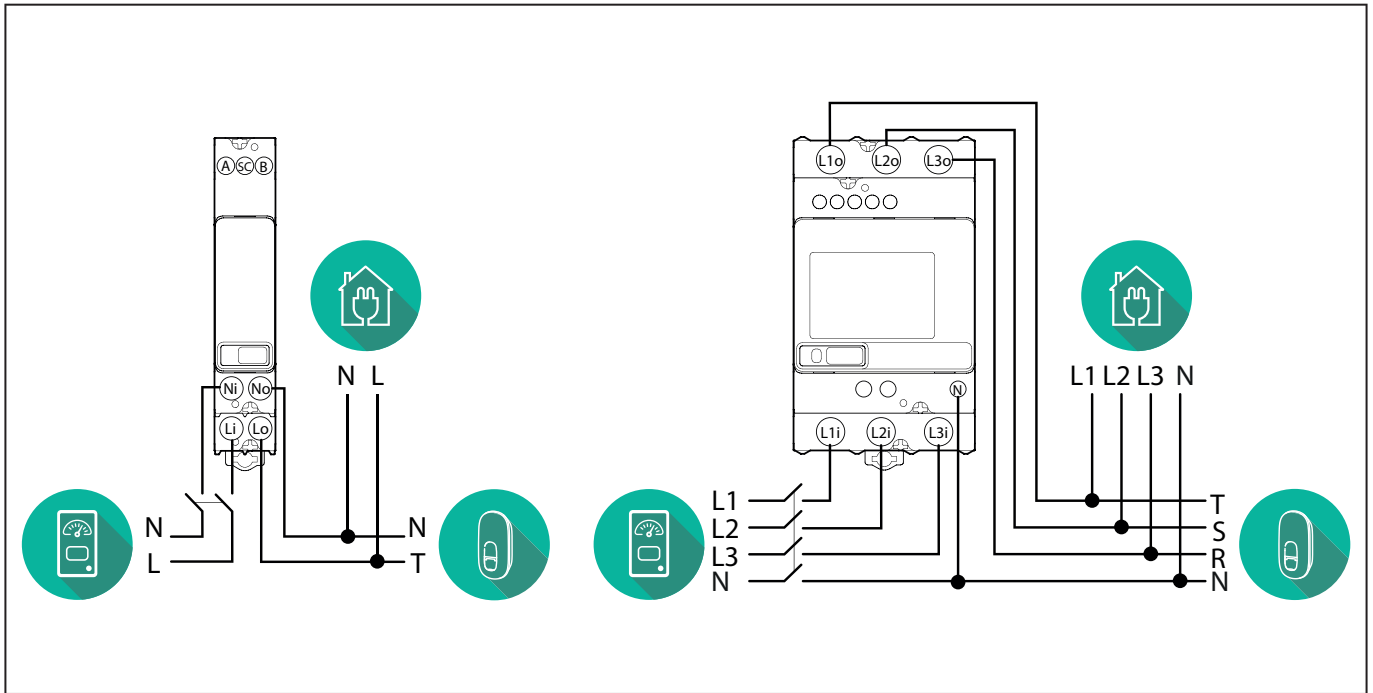

Gavazzi model 1ph and 3ph

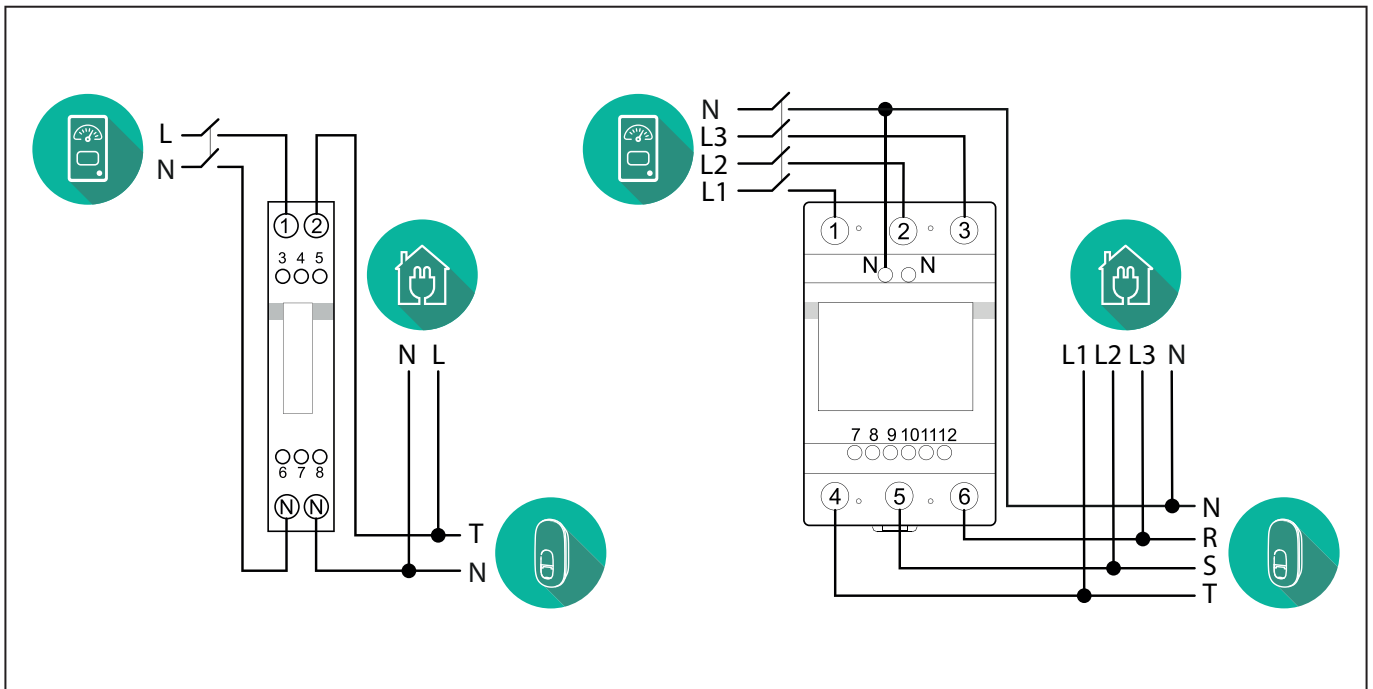

NOTICE:



- 1) If PV is present, the **PowerMeter** should be placed between the Utility Meter and the PV connection point.
- 2) If there is a home Energy storage, the **PowerMeter** should be placed between the Energy storage connection point and the Energy storage measurement sensor.

For Indirect models of the PowerMeter:

Place the CT (current transformer) of the **PowerMeter** after the main utility meter and before the main switch of the house/building. The current transformer must measure all the domestic loads, including the **eLuxWallbox**.

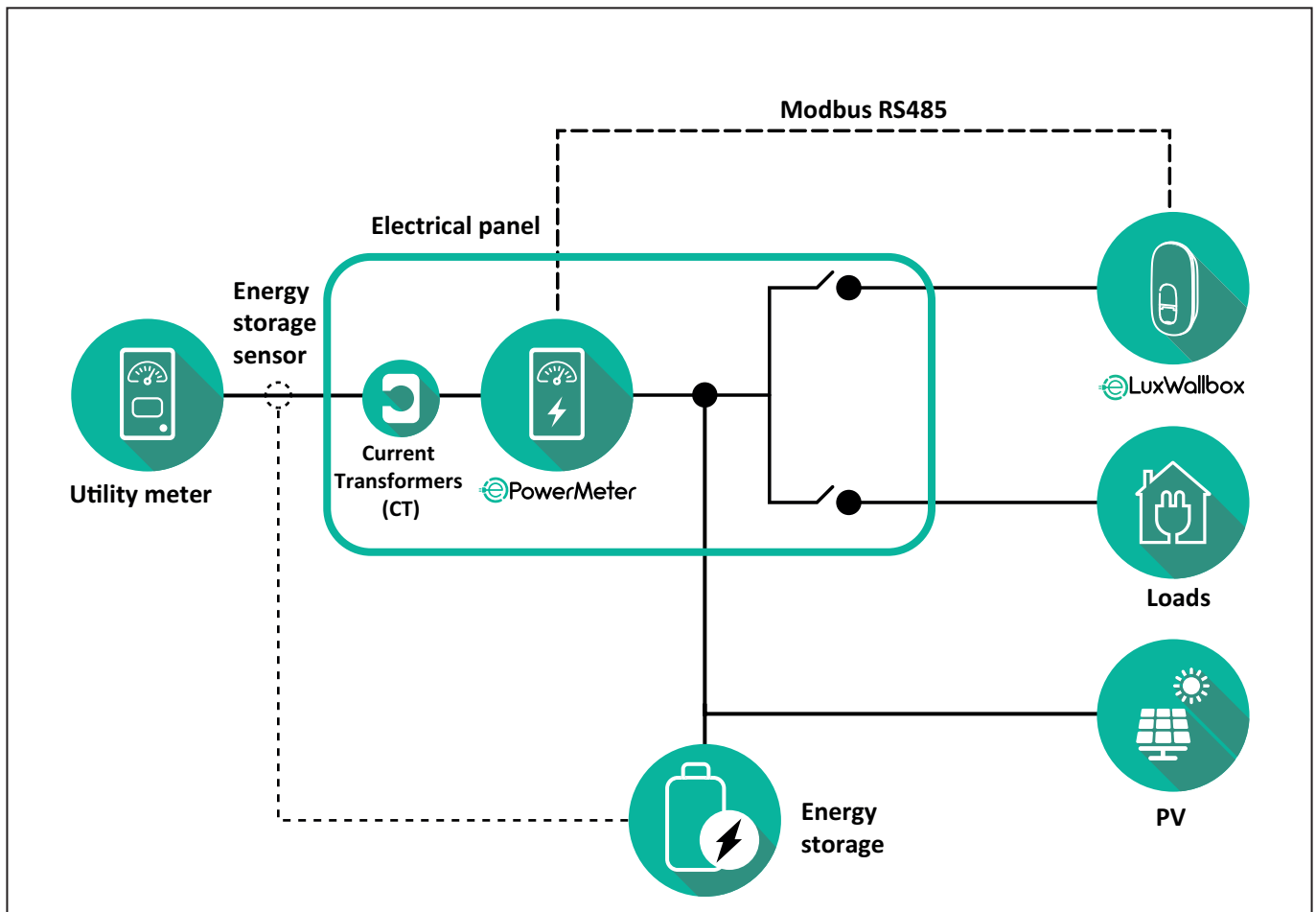

NOTICE:



1) If PV is present, the **PowerMeter** Current Transformers (CT) should be placed between the PV connection point and the Utility Meter.

2) If there is a home Energy storage, the **PowerMeter** Current Transformers (CT) should be placed between the Energy storage connection point and the Energy storage measurement sensor.

Connect the Current Transformers (CT) as indicated in the meter installation manual. Point the arrow on the CT in the direction of the loads.

For the three-phase or single-phase electrical connection of the indirect **PowerMeter**, refer to the diagrams below.

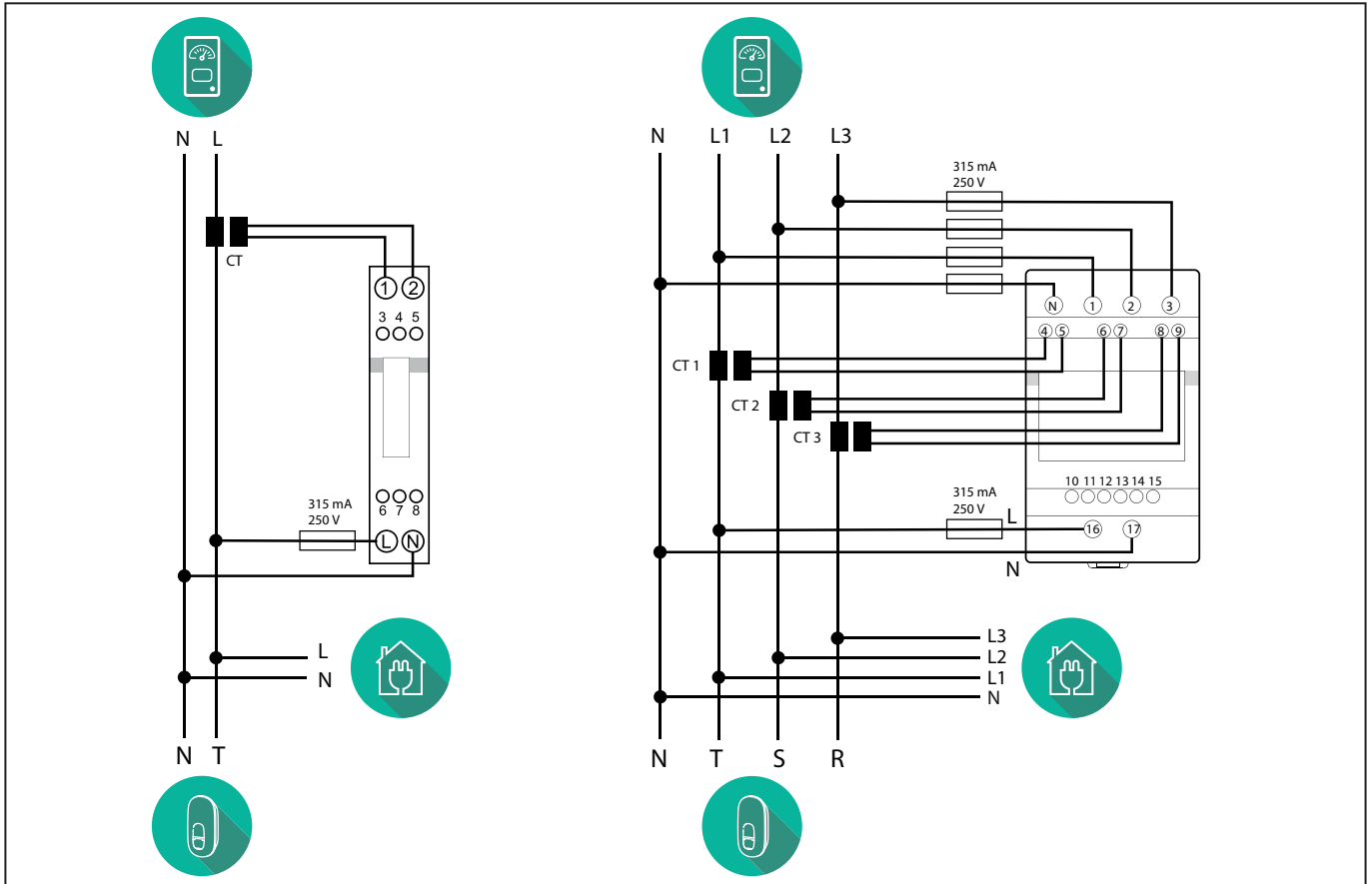

3.2. Installing MIDcounter

The **MIDcounter** is a certified energy meter that allows the consumption of the charger to be safely and reliably monitored during each charging session.

All the relevant data of the charging sessions is automatically recorded by a certified **MID** meter and transferred from the charger to the Charge Point Management System (CPMS).



WARNING: The power to the charger must remain off during this step.

Place the **MIDcounter** on the same power line as the charger, after the electrical protection devices.

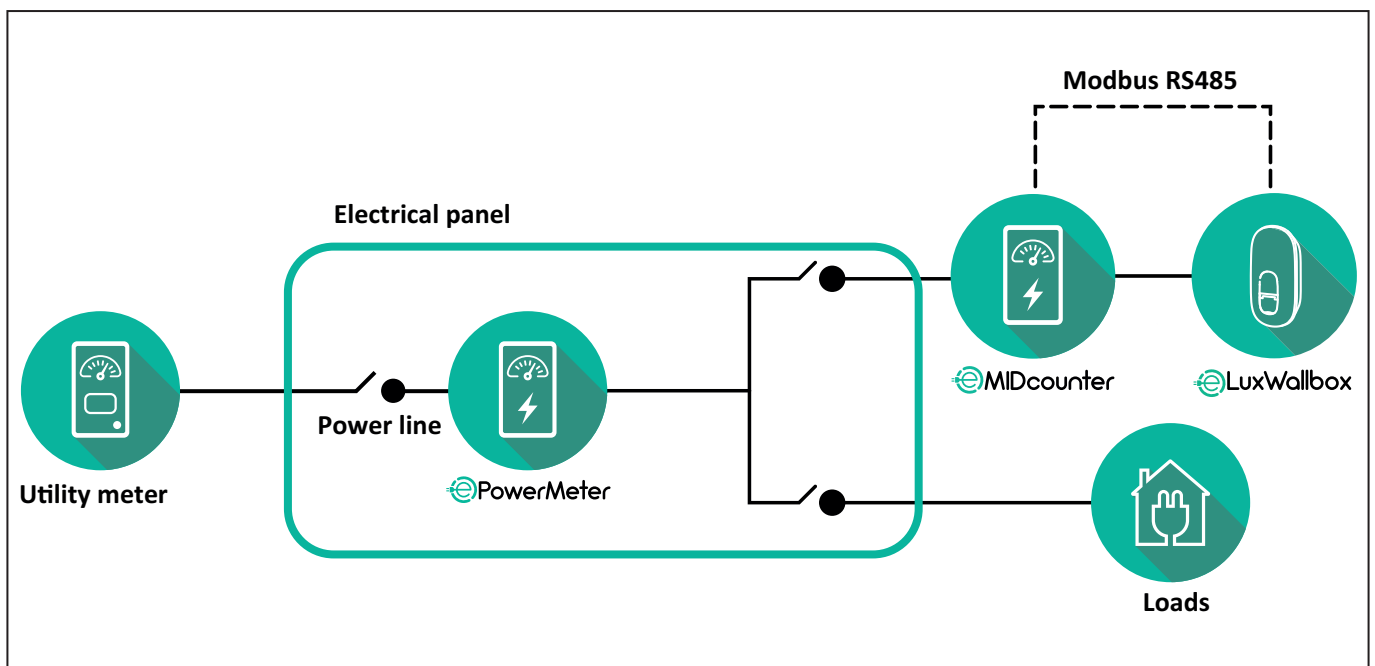

See the diagrams below for single phase and three phase electrical connection of **MIDcounter** (Finder and Gavazzi).

**Finder 1-phase, Direct, 40 A
(7M2482300210)**

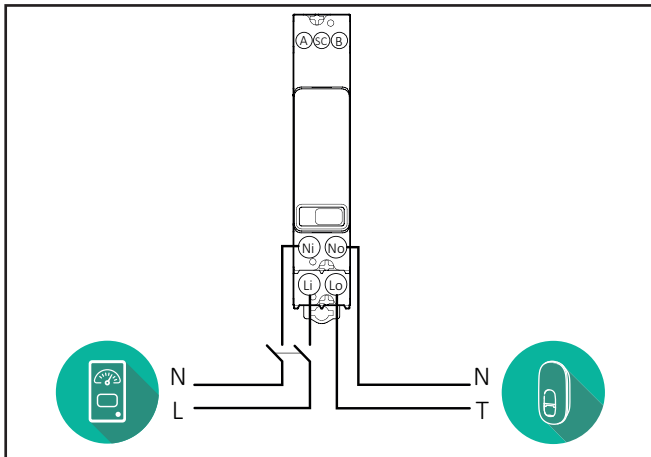

**Gavazzi, 3-phase, Direct, 65 A
(EM340DINAV23XS1PFB)**

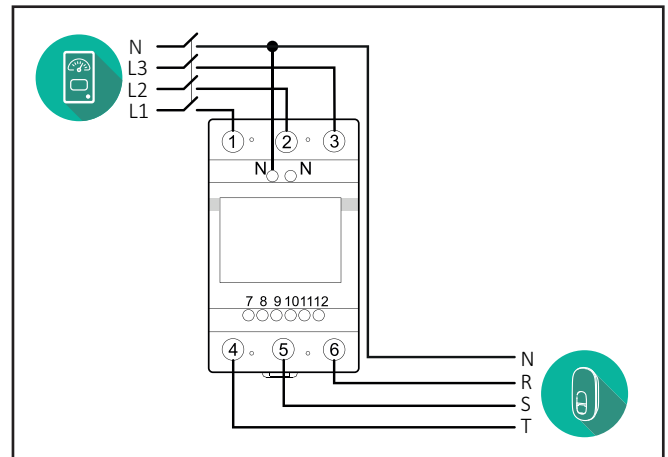

**Finder 3-phase, Direct, 80 A
(7M3884000212)**

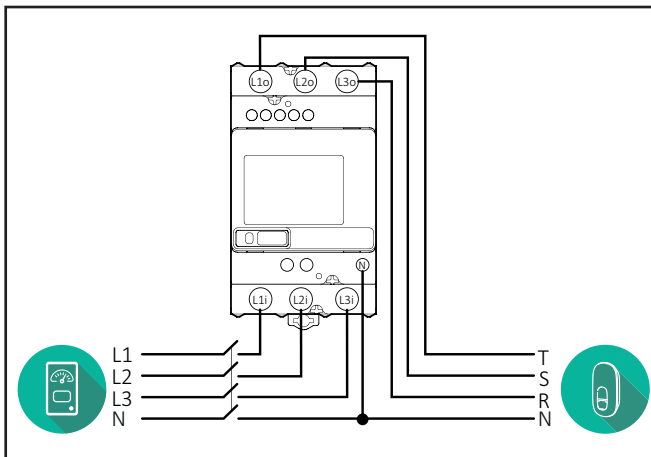

**Gavazzi, 1 phase, Direct, 100 A
(EM112DINAV01XS1PFB)**

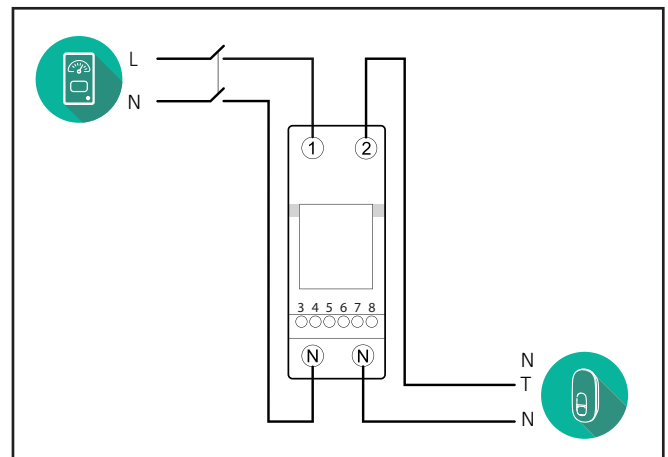

**Gavazzi, 1-phase, Direct, 32 A
(EM111DINAV81XS1PFB)**

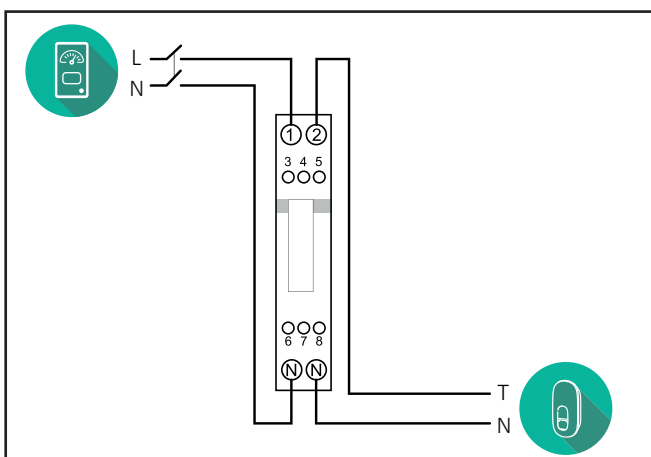

3.3. Communication cable installation

Install a communication cable between the **PowerMeter (DPM)** and the **eLuxWallbox**.

- On the **eLuxWallbox**, remove the protective cap of the communication cables entry point and insert the \varnothing 25 mm corrugated sheath.
- Tighten the box-cable sheath junction.
- Insert the communication cable, pulling it to a suitable length so that it reaches the communication port CN12, leaving some slack.
- Connect the Modbus RS485 communication cable to the GND, - and + pins of the CN12 connector.



NOTE: It is possible to replace the box-cable sheath junctions with \varnothing 25mm cable gland (not provided by the manufacturer).

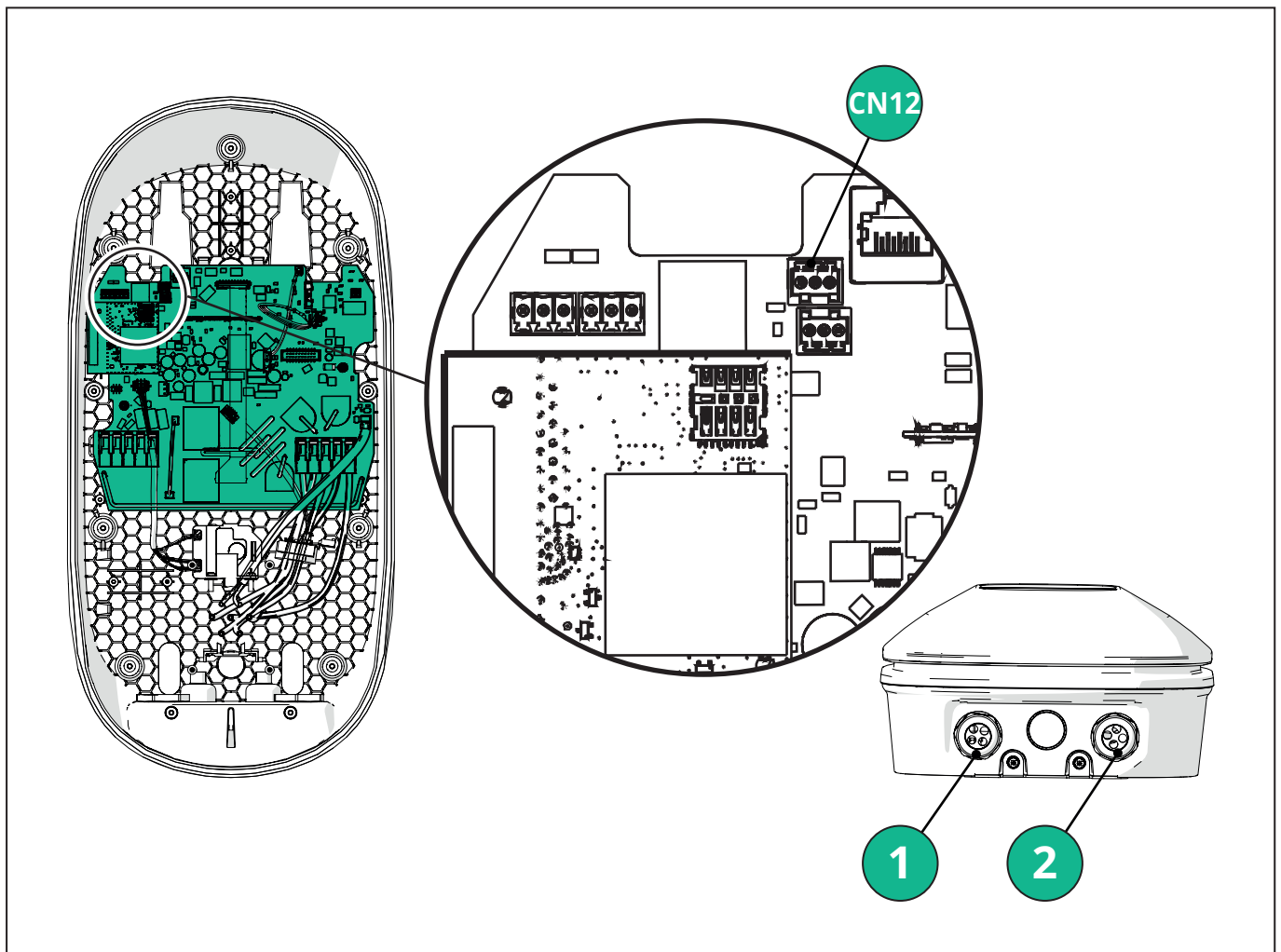

1 - Power supply cables

2 - Communication cables

CN12 - RS485 Modbus for external meter communication (**DPM** and **MID**)

Connect the communication cables in the following order from the **PowerMeter (DPM)** to **eLuxWallbox**.



WARNING: If the installation includes both accessories, follow the instructions for “MIDcounter and PowerMeter (DPM) combined installation”.

CN12	Finder 1ph 7M.24.8.230.0210
GND	SC
-	B
+	A

CN12	Gavazzi 3ph EM340DINAV23XS1PFB
GND	10
-	9
+	8

Junction 9/7

CN12	Finder 3ph 7M.38.8.400.0212
GND	SC
-	B
+	A

CN12	Gavazzi Ind 1ph EM111DINAV51XS1X / EM111DINMV51XS1X
GND	7
-	8
+	6

Junction 8/5

CN12	Gavazzi 1ph EM111DINAV81XS1PFB
GND	7
-	8
+	6

Junction 8/5

CN12	Gavazzi Ind 3ph EM330DINAV53HS1X
GND	13
-	12
+	11

Junction 12/10

3.4. MIDcounter and PowerMeter (DPM) combined installation

If installing both electrical accessories, the positioning of **MIDcounter** together with the **PowerMeter (DPM)** is indicated in the diagram below:

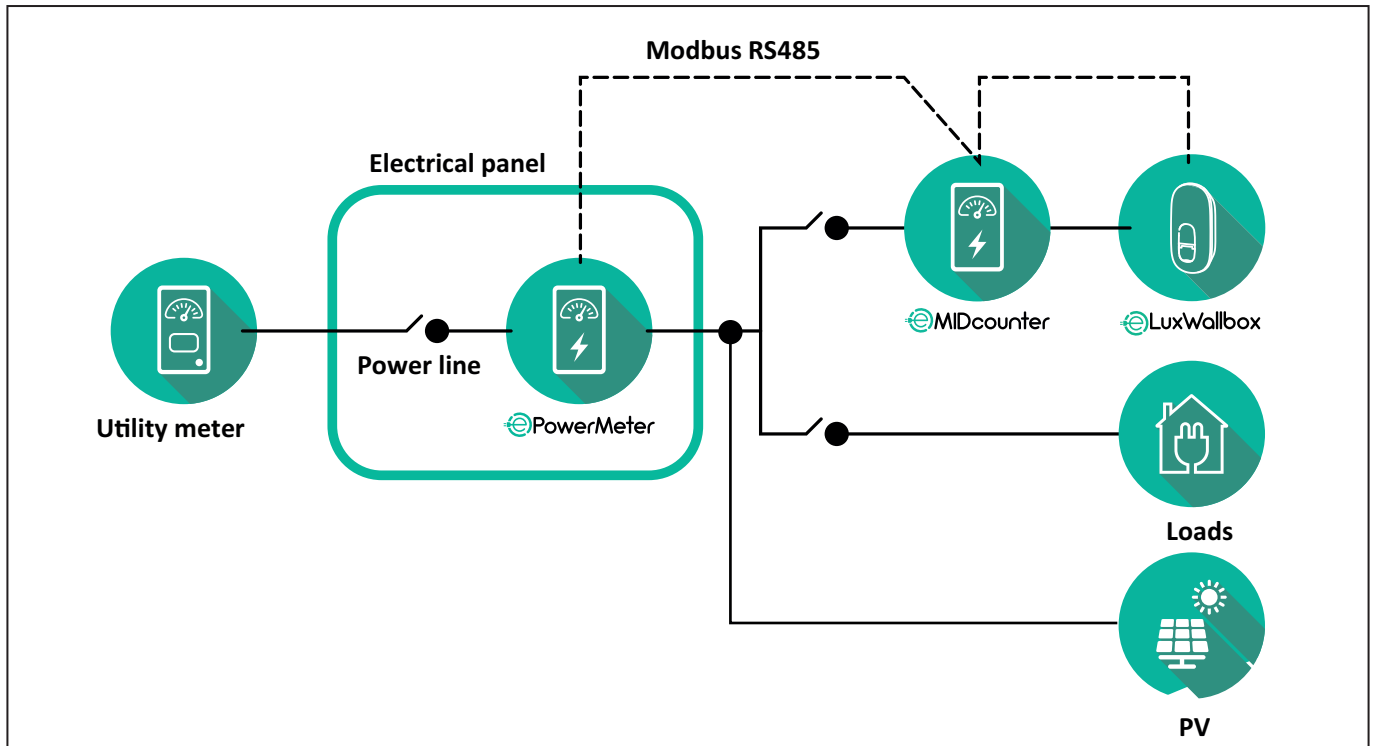

Connect the Modbus communication cables. The **PowerMeter (DPM)**, **MIDcounter** and the **eLuxWallbox** must be connected on the same communication bus in a Daisy chain format.

On the **eLuxWallbox**:

- Remove the protective cap of the communication cable entry point and insert the \varnothing 25 mm corrugated sheath.
- Tighten the box-cable sheath junction.
- Insert the communication cable, pulling it to a suitable length so that it reaches the communication port CN12, leaving some slack.
- Connect the Modbus RS485 communication cable to the GND, - and + pins of the CN12 connector.

Use the table below to connect the communication cables from the accessories to the **eLuxWallbox**.

Single-Phase.

PowerMeter (DPM)	MIDcounter	eLuxWallbox
EM111DINAV51XS1X - EM111DINMV51XS1X	EM111DINAV81XS1PFB	CN12
GND (7)	GND (7)	GND
A- (8) / T*(5)	A- (8)	-
B+ (6)	B+ (6)	+
EM111DINAV51XS1X - EM111DINMV51XS1X	7M 24.8.230.0210	CN12
GND (7)	SC	GND
A-(8) / T*(5)	B-	-
B+ (6)	A+	+
EM111DINAV81XS1PFB	EM111DINAV81XS1PFB	CN12
GND (7)	GND (7)	GND
A-(8) / T*(5)	A- (8)	-
B+ (6)	B+ (6)	+
EM111DINAV81XS1PFB	7M 24.8.230.0210	CN12
GND (7)	SC	GND
A-(8) / T*(5)	B-	-
B+ (6)	A+	+
7M 24.8.230.0210	EM111DINAV81XS1PFB	CN12
SC	GND (7)	GND
B-	A- (8)	-
A+	B+ (6)	+
7M 24.8.230.0210	7M 24.8.230.0210	CN12
SC	SC	GND
B-	B-	-
A+	A+	+

Three-Phase.

PowerMeter (DPM)	MIDcounter	eLuxWallbox
EM330DINAV53HS1X	EM340DINAV23XS1PFB	CN12
GND (13)	GND (10)	GND
A-(12) / T*(10)	A-(9)	-
B+ (11)	B+ (8)	+
EM330DINAV53HS1X	7M.38.8.400.0212	CN12
GND (13)	SC	GND
A-(12) / T*(10)	B-	-
B+ (11)	A+	+
EM340DINAV23XS1PFB	EM340DINAV23XS1PFB	CN12
GND (10)	GND (10)	GND
A-(9) / T*(7)	A-(9)	-
B+ (8)	B+ (8)	+
EM340DINAV23XS1PFB	7M.38.8.400.0212	CN12
GND (10)	SC	GND
A-(9) / T*(7)	B-	-
B+ (8)	A+	+
7M.38.8.400.0212	EM340DINAV23XS1PFB	CN12
SC	GND (10)	GND
B-	A-(9)	-
A+	B+ (8)	+
7M.38.8.400.0212	7M.38.8.400.0212	CN12
SC	SC	GND
B-	B-	-
A+	A+	+

*A 120 Ω terminating resistor must be installed on the devices at the ends of the Modbus chain. The resistor is present by default in the **eLuxWallbox**. Gavazzi models have a built-in resistor, which can be enabled by making a jumper between these terminals.

4. PowerMeter (DPM) and MIDcounter configuration

Power on the **PowerMeter (DPM)** and/or the **MIDcounter** when the electrical installation and communication installation are complete. Then proceed with the configuration on the display of the meters.

The configuration varies depending on the model.

4.1. Finder models

The following actions help to understand how to set Finder energy meters:

- Press the touchscreen button (a,b) to move between menus and parameters;
- Long press (~ 2 seconds) the touchscreen button (a,b) to enter and confirm selections

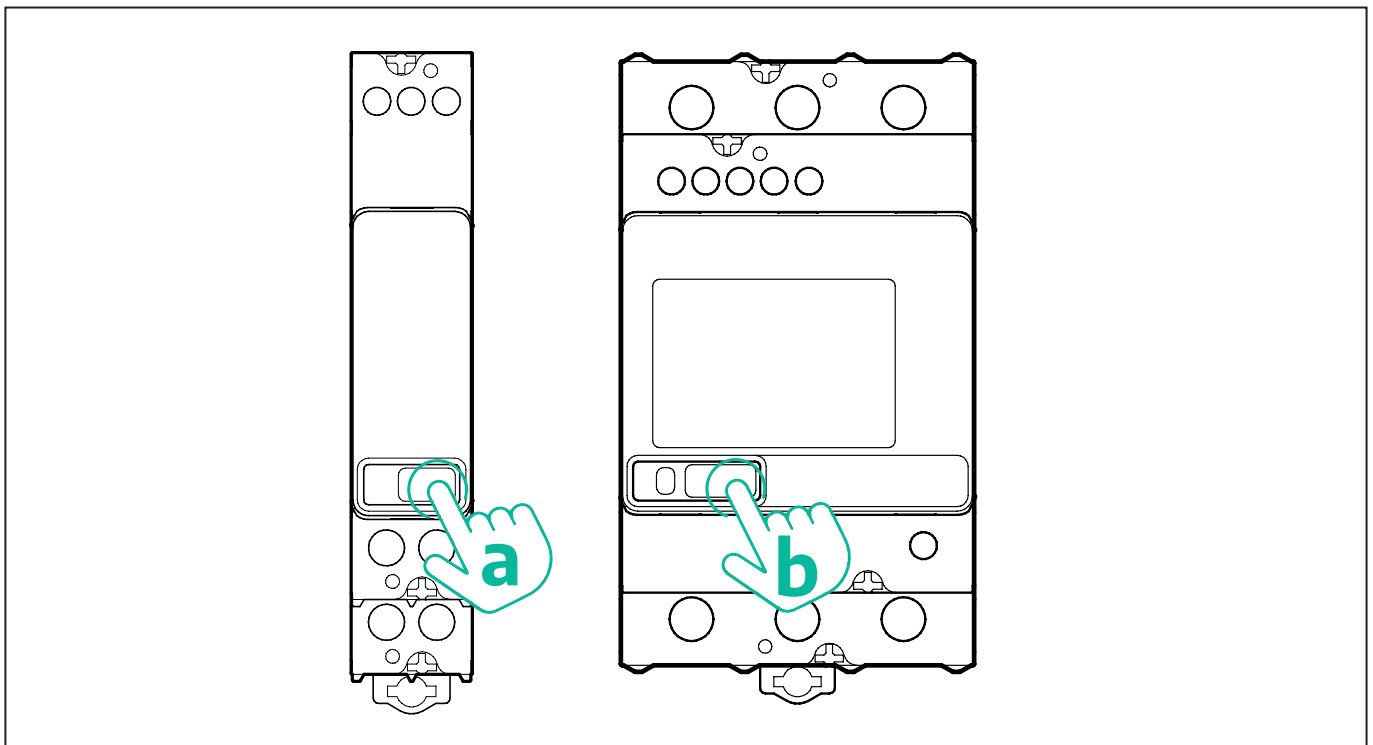

Follow the next steps to correctly configure the single-phase or three-phase Finder energy meters:

- When powering up the energy meter for the first time, long press the touchscreen button (a,b) until the display text blinks in order to enter the "MAIN" menu;
- Scroll the "MAIN" menu pressing the touchscreen button (a,b), then select "SETTING" ("SET" on single-phase meter). Long press to enter the selection.
- Scroll the "SETTING" menu pressing the touchscreen button (a,b), then select "COMMUNICATION" ("COMM" on single phase meter). Long press to enter the selection.
- Insert the correct values indicated in the table below. To modify the value press the touchscreen button (a,b), long press to confirm.

Only for three-phase Finder meter (in addition to previous options):

- Long press the touchscreen button (a,b) until the display text blinks in order to enter the "MAIN" menu (or return to the "MAIN" menu)
- Scroll the "MAIN" menu pressing the touchscreen button (a,b), then select "INSTALLATION". Long press the touchscreen button (a,b) to enter the selection
- Scroll the "INSTALLATION" menu pressing the touchscreen button (a,b) and then select the following option
 - "Communication mode" = "3L+N, L+N-Arithmetic"
 - Once the correct option is confirmed, enter the password: "DCBA" **Attention:** configuration cannot be modified after entering the password **DCBA**
 - Confirm the change selecting "Yes" when prompted.

ALL FINDER MODELS	PowerMeter (DPM)	MIDcounter
DEVICE ADDRESS	1	2
BITS PER SECOND (BAUD)	38400 bit/s	38400 bit/s
PARITY	Even	Even
STOP BIT	1	1
Additional for three-phase type		
	PowerMeter (DPM)	MIDcounter
COMMUNICATION MODE	3L+N, L+N-Arithmetic	3L+N, L+N-Arithmetic
PASSWORD	DCBA	DCBA

4.2. Gavazzi models

The following actions help to understand how to set Gavazzi energy meters:

- Press the touchscreen buttons (c, d, e, g) to move between menus and values
- press (~ 2 seconds) the touchscreen button (d, f) to enter the menu and confirm selections

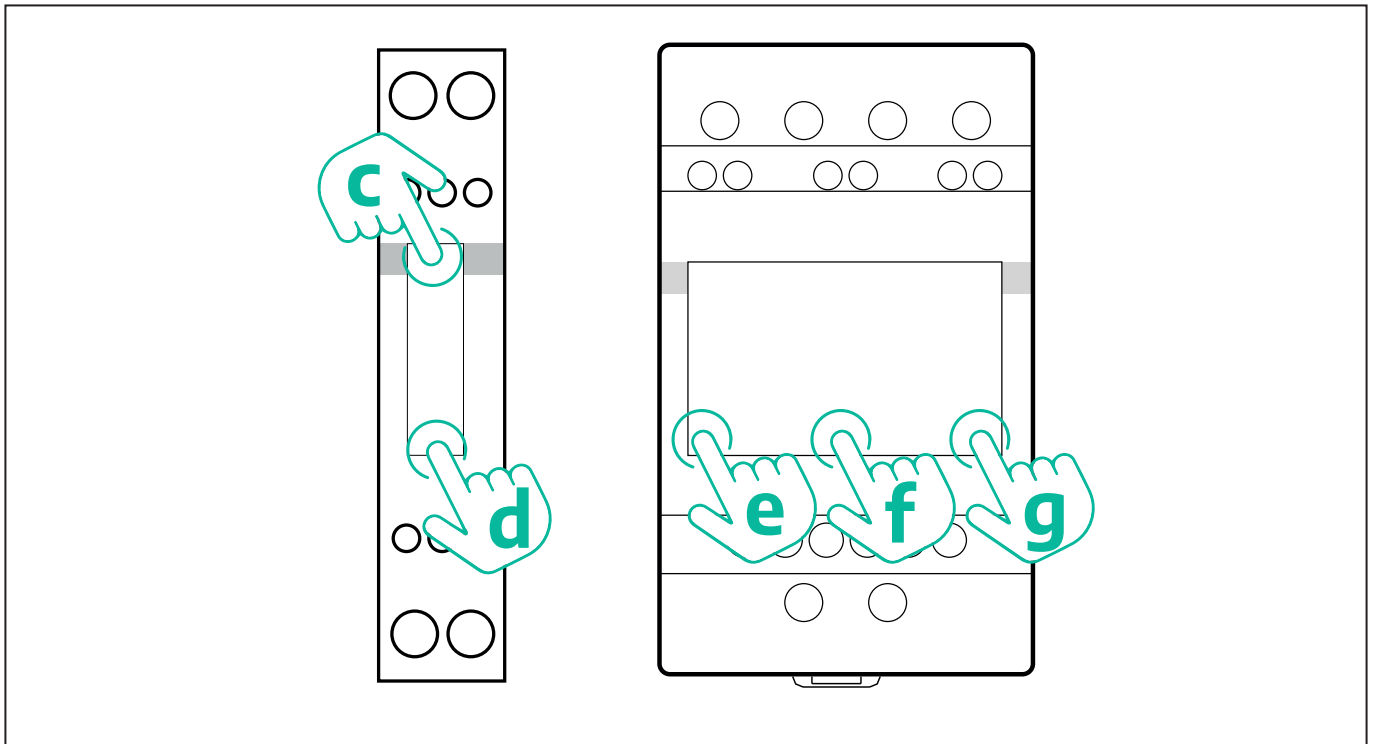

Follow the next steps to correctly configure the single-phase Gavazzi direct and indirect energy meters.

- When powering up the energy meter for the first time, long press the touchscreen button (d) until the password appears on the screen
- Long press the buttons (c, d) simultaneously in order to confirm the password "0000" and enter the "MAIN" menu
- Scroll the "MAIN" menu pressing the upper button (c) and then select the following options in the table below

Follow the next steps to correctly configure the three-phase Gavazzi direct and indirect energy meters:

- When powering up the energy meter for the first time, long press the central button (f) until the password appears on the screen;
- Long press the buttons (e, g) simultaneously in order to confirm the password "0000" and enter the "MAIN" menu
- Scroll the "MAIN" menu pressing the buttons (e or g) and then select the options in the table below

ALL GAVAZZI MODELS	PowerMeter (DPM)	MIDcounter
PASS	0000	0000
ADDRESS	001	002
BAUD	38.4	38.4
PARITY	Even	Even
Additional for three-phase type		
	PowerMeter (DPM)	MIDcounter
SYSTEM	3Pn	3Pn
ADDRESS	001	002

4.3. Device configuration summary

EM340DINAV23XS1PFB / EM330DINAV53HS1X		EM340DINAV23XS1PFB	
PASS	0000	PASS	0000
SYSTEM	3Pn	SYSTEM	3Pn
ADDRESS	1	ADDRESS	2
BAUD	38.4	BAUD	38.4
PARITY	EVEN	PARITY	EVEN

EM111DINAV81XS1PFB / EM111DINAV51XS1X / EM111DINMV51XS1X		EM111DINAV81XS1PFB	
PASS	0000	PASS	0000
ADDRESS	001	ADDRESS	002
BAUD	38.4	BAUD	38.4
PARITY	EVEN	PARITY	EVEN

7M 24.8.230.0210		7M 24.8.230.0210	
DEVICE ADDRESS	__ 1	DEVICE ADDRESS	__ 2
BITS PER SECOND (BAUD)	38400 bit/s	BITS PER SECOND (BAUD)	38400 bit/s
PARITY	EVEN	PARITY	EVEN
STOP BIT	1	STOP BIT	1

7M.38.8.400.0212		7M.38.8.400.0212	
DEVICE ADDRESS	__ 1	DEVICE ADDRESS	__ 2
BITS PER SECOND (BAUD)	38400 bit/s	BITS PER SECOND (BAUD)	38400 bit/s
PARITY	EVEN	PARITY	EVEN
STOP BIT	1	STOP BIT	1
CONNECTION MODE	3L+N, L+N - Arithmetic	CONNECTION MODE	3L+N, L+N - Arithmetic
PASSWORD	DCBA	PASSWORD	DCBA

4.4. PowerMeter (DPM) and MIDcounter configuration on APP

To complete installation, the final configuration of the **eLuxWallbox** and its accessories should be set via the dedicated app

PowerUp is a smartphone app for qualified installers only, available via Google Play™ and Apple Store®. The configuration is carried out via a Bluetooth connection. The wallbox cannot operate correctly if not configured via the app.



NOTICE: Make sure you have the latest version of PowerUp to have access to all of the features.

Follow the instructions below to get started with the app:

Download PowerUp to your smartphone and activate Bluetooth on the smartphone.



Scan **eLuxWallbox** QR code to pair it with the app. The QR Code can be found on the side of the charger.

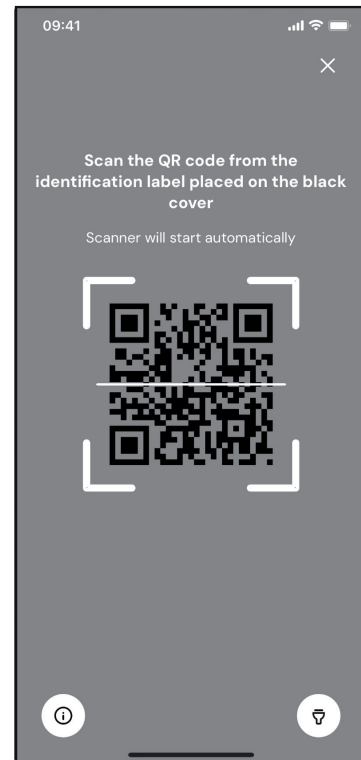

Once paired, complete the configuration set up of **eLuxWallbox** and its Accessories by clicking on the parameter to be configured.

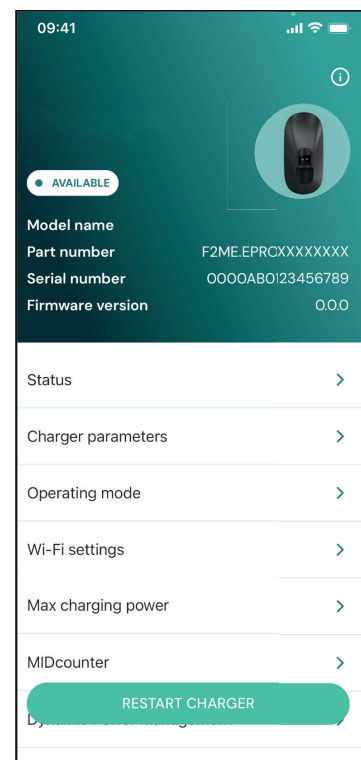

4.5. PowerMeter (DPM) configuration

To complete installation of the **PowerMeter (DPM)**, follow the steps below:

Select "**DPM PowerMeter**" on the homepage

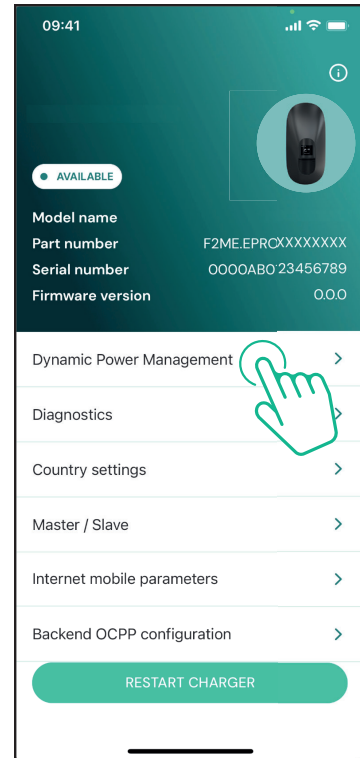

Select the **PowerMeter** type from the drop-down menu, matching the model installed.

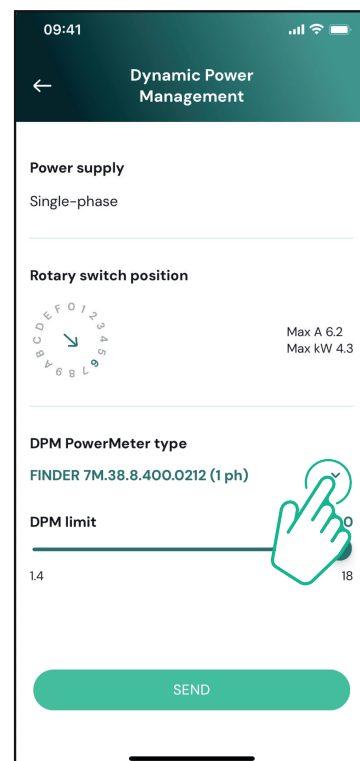

Enter the value of the user contractual power as **DPM** power limit.

For Indirect Meter only - Set the CT current ratio with the slider.

- With CTV 60 A set 60 as Current ratio
- With CTA 100 A set 20 as Current ratio
- With CTA 150 A set 30 as Current ratio

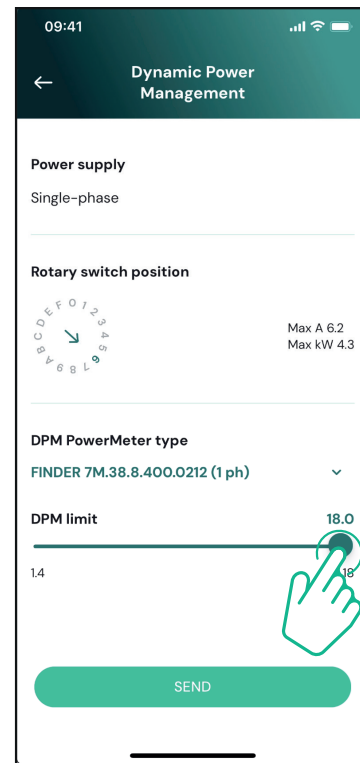

Click "Send" and confirm on the pop-up to restart **eLuxWallbox**.

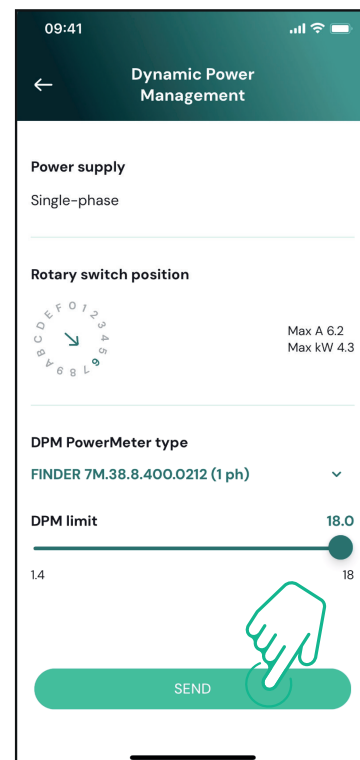

4.6. MIDcounter configuration

To complete installation of the **MIDcounter**, follow the steps below:

Select "**MIDcounter**" on the homepage

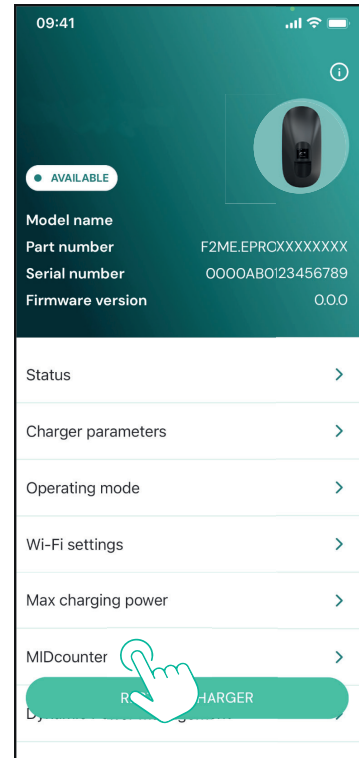

Select the **MIDcounter** type from the drop down menu, based on the model installed.

Select "OFF" from the drop down menu to disable the **MIDcounter** configuration.

Click "Send" to confirm.

To make the changes effective, click on the back arrow in the top left corner and restart **eLuxWallbox** through the dedicated button in the homepage.

If the installation has both the **PowerMeter (DPM)** and the **MIDcounter** it is possible to proceed with **DPM** configuration before restarting.

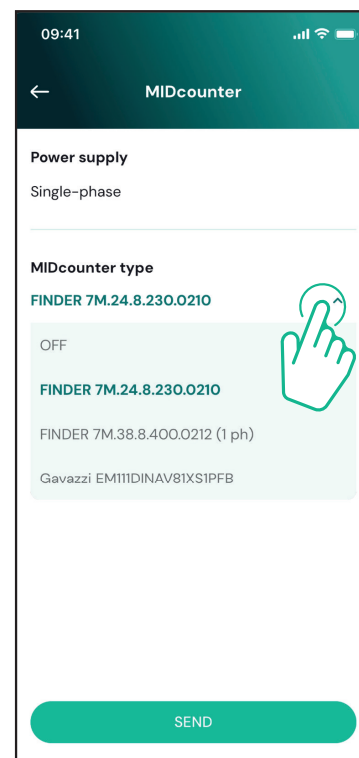

5. TROUBLESHOOTING

Error conditions are stored in the diagnostic logs and shown on the charger panel:

- On the **eLuxWallbox Move** model, the LED bar blinks red. See the **Diagnostic** section of PowerUP or the end-user App for the detailed error code.
- On the **eLuxWallbox** model, the display shows the error code, which is also available in the **Diagnostic** section of PowerUP.

When an error occurs, the charge is interrupted, and the socket is unlocked to allow you to disconnect the plug.

The following table provides a list of errors that can occur and the relative troubleshooting. If the error persists, note the serial number on the charger label and contact Customer Service.

Error code / issue	"Error Description"	Troubleshooting
100	Lack of power supply	<p>Check if the circuit breaker is ON. Check that the CN1 cabling is correct. Check the voltage in CN1.</p>
101	Overheating	<p>Disconnect the Type 2 cable, wait for the temperature to drop, then the error will clear.</p> <p>To restart the charging session, plug in the cable again. Make sure that installation site is compatible with temperature range (25°C/+50°C without direct exposure to sunlight)</p>
102	Communication error between MCU and MPU.	<p>Restart the charger from the circuit breaker, leaving the charger switched off for at least 60 seconds.</p>
103	Hardware fault, ground protection device error (GPD error)	<p>Check the cabling on CN1:</p> <ul style="list-style-type: none"> - in single-phase, make sure that ground cable is connected to PE, the Neutral cable is connected to N and the phase cable to T - in three-phase, make sure that the ground cable is connected to PE, the Neutral cable is connected to N and the phase cables L1, L2 and L3 are connected to T, S, and R. <p>Check whether the voltage difference between PE and N does not exceed 10V. Check PE connection</p> <p>If all connections are checked and the error persists, open the charger and modify the configuration of the Dipswitch (SW2) connector.</p>

104	Hardware fault, residual current monitor AC error. (RCM AC trip)	<p>Try to start a new charging session, removing and plugging in all the connectors.</p> <p>If the problem persists, check for the presence of any problems in the charging cable or vehicle inlet.</p> <p>If the cables and the EV don't show any problem, check CN27 connector and RCM cable.</p>
105	Hardware fault, residual current monitor DC error. (RCM DC trip)	<p>Check that the problem is not with the cable or vehicle. If possible, try another charging session with a different cable or vehicle.</p>
106	Internal meter error	<p>Restart the charger from the circuit breaker, leaving the charger switched off for at least 60 seconds.</p>
107	PowerMeter (DPM) communication error	<p>Check that the communication configuration on the DPM PowerMeter device is correct.</p> <p>Check that the DPM model configuration in the installer App is correct.</p> <p>Check the communication cable wiring on CN12.</p> <p>Check that the communication cable used is suitable for Modbus RS485 and cable length.</p>
108	Configuration Error, Rotary switch position (supply type) is not consistent with the DPM/ MID type.	<p>Check the position of the rotary switch. If it is not consistent with the 1-ph/3-ph installation, change it according to the table in the manual, then restart the charger.</p> <p>If the accessories (DPM/MID) are not installed, make sure that the function is disabled in the installer App.</p> <p>If the accessories (DPM/MID) are installed, check that the correct model is selected on the installer App. Then restart the charger.</p>
109	Main/secondary RS485 communication error	<p>Check the configuration of the Main/Secondary set up from installer App.</p> <p>Check that the Main charger is available.</p> <p>Check that the wiring of the communication cable on CN9 and CN10 is correct.</p> <p>Check that the communication cable used is suitable for Modbus RS485.</p>

110	MIDcounter communication error	<p>Check that the communication configuration on the MIDcounter device is correct.</p> <p>Check the communication cable wiring on CN12.</p> <p>Check that the communication cable used is suitable for Modbus RS485.</p> <p>Check that the MID model configuration in the installer App is correct.</p>
300	Inconsistency between the charger contactor command and feedback	<p>Restart the charger from the circuit breaker, leaving the charger switched off for at least 60 seconds.</p> <p>If error persists even after restart, call Customer Service.</p>
301	Short circuit detected on the Control Pilot line.	<p>With the charger switched off, check that there is no damage and no defects inside and outside the socket (if so, avoid using the charger and contact Customer Service).</p> <p>Check that the problem is not related to the cable or vehicle and try another charge session (with another vehicle or cable if possible).</p>
302	State E or F set on the Control Pilot line.	<p>With the charger switched off, check that there is no damage and no defects inside and outside the cable and its connectors (if so, avoid using it and attempt charge with another cable).</p>
303	Control Pilot disconnected.	<p>Check that the cable connectors are fully inserted inside the charger socket and vehicle inlet.</p>
304	Proximity Pilot disconnected.	<p>Check that the problem is not related to the cable or vehicle and try another charge session (with another vehicle or cable if possible).</p>
305	Broken Proximity Pilot detected.	<p>Check that the problem is not related to the cable or vehicle and try another charge session (with another vehicle or cable if possible).</p>
306	Diode fault detected on Control Pilot line (no - 12V).	<p>Attempt a new charging session unplugging and reinserting the cable from both the charger and vehicle inlet.</p>
307	Control Pilot disconnected.	<p>With the charger switched off, check that there is no damage and no defects inside and outside the cable and its connectors (if so, avoid using it and attempt charge with another cable).</p> <p>Check that the cable connectors are fully inserted inside the charger socket and vehicle inlet.</p> <p>Check that the problem is not related to the cable or vehicle and try another charge session (with another vehicle or cable if possible).</p>

308	Inconsistency between the motor command and feedback, or the motor is in an error condition.	<p>Attempt a new charging session unplugging and reinserting the cable from both the charger and vehicle inlet.</p> <p>Check that the cable connectors are fully inserted inside the charger socket and vehicle inlet.</p>
309	Motor check error during EVSE initialization phase.	Restart the charger from the circuit breaker, leaving the charger switched off for at least 60 seconds.
310	Error detected before charging (PP not detected, or motor fault, or CP not detected).	<p>With the charger switched off, check that there is no damage and no defects inside and outside the cable and its connectors (if so, avoid using it and attempt charge with another cable).</p> <p>Check that the cable connectors are fully inserted inside the charger socket and vehicle inlet.</p>
311	Error detected after charging (motor fault, or CP not disconnected).	Check that the problem is not related to the cable or vehicle and try another charge session (with another vehicle or cable if possible).
312	Emergency stop received from the MPU.	Restart the charger from the circuit breaker, leaving the charger switched off for at least 60 seconds.
313	Current detected during charging, with 100% duty cycle on the Control Pilot line.	Check that the problem is not cable nor vehicle related, attempt a new charging session with another cable and/or charger.
315	Current over limits on phase L1	Unplug the cable, if possible lower the power of charge on the vehicle side and attempt a new charging session.
316	Current over limits on phase L2	
317	Current over limits on phase L3	
318	Voltage below a threshold on phase L1	<p>Check the rotary switch position is consistent with 1-ph/3-ph installation.</p> <p>Check that the voltage on CN1-T is above 196 V.</p> <p>If the voltage is below 196 V, check the electric system or contact the energy supplier.</p> <p>If an error occurs during vehicle charging, try to reduce the set-up charging power and verify that the electric system is correctly dimensioned for the power drawn by the vehicle.</p>

319	Voltage below a threshold on phase L2	The rotary switch is in a three-phase position. Check that the intended installation is in three-phase. If not, select the correct rotary switch position as per Installation Manual.
320	Voltage below a threshold on phase L3	<p>Check that the voltage on CN1-S and R is above 196 V. If the voltage is below 196V, check the electric system or contact the energy supplier.</p> <p>If an error occurs during vehicle charging, try to reduce the set-up charging power and verify that the electric system is correctly dimensioned for the power drawn by the vehicle.</p>
321	Forbidden state change (IEC 61851-1)	<p>EV does not meet IEC 61851-1 standards for starting a charge session.</p> <p>Attempt a new charging session unplugging and reinserting the cable from both the charger and vehicle inlet.</p> <p>If the error persists, contact the vehicle manufacturer.</p>
	Display/LED stuck in Welcome mode (LED blinks red-green-blue)	Restart the charger from the circuit breaker, leaving the charger switched off for at least 60 seconds.
	LED or display does not light up at startup	
	The charger does not start	<p>Let the unit restart, it may take up to 30 seconds.</p> <p>Check if the circuit breaker is ON.</p> <p>Check that the CN1 cabling is correct.</p> <p>Check the voltage in CN1.</p> <p>Restart the charger from the circuit breaker, leaving the charger switched off for at least 60 seconds.</p>
	Cable stuck in the charger socket	Turn off the charger from the circuit breaker, then remove the cable.
	Suspended Charging with solid green LED/ message on the display. The charging session is suspended by the DPM or the EV. The session may resume.	<p>Verify that the max power in the DPM power limit section of the installer App is consistent with the contract power value in kW as indicated in the user's electricity contract. If the value is correct, wait for the charging session to resume or turn off some house loads.</p> <p>In the case of 3-ph installation, verify that the electrical loads are well balanced on the phases of the domestic system.</p>

	<p>App pairing does not complete after QR scan.</p>	<p>Check the integrity of the QR code on the label. Update the App to the latest version. Close and restart the App, then try again. Restart the charger from the circuit breaker, leaving the charger switched off for at least 60 seconds.</p>
--	---	---

6. CLEANING

Cleaning the outside of the device is always recommended when necessary and should be carried out using a soft damp cloth with a mild detergent. When finished, wipe off any traces of moisture or liquid with a soft dry cloth.



CAUTION: Avoid strong jets of air or water as well as the use of soaps or detergents that are too harsh and corrosive for the materials of the charger.

7. PACKAGING DISPOSAL



Dispose of packaging in an environmentally friendly manner. The materials used for packaging this product can be recycled and must be disposed of in compliance with the legislation in force in the country of use. The following disposal directions will be found on the packaging based on the type of material.



NOTE: Further information about current disposal facilities can be obtained from local authorities.

8. ASSISTANCE

If you have any questions about the installation of **eLuxWallbox**. For any other information or requests for support, please contact Free2move eSolutions S.p.A. through the relevant section of its website: www.esolutions.free2move.com.

9. DISCLAIMER

Free2move eSolutions S.p.A. will not be held responsible for any damage directly or indirectly caused to people, things or animals due to the failure to comply with all the provisions set out in this Manual, and the warnings regarding the installation and maintenance of **eLuxWallbox**.

Free2move eSolutions S.p.A. reserves all rights to this document, the article and the illustrations it contains. The reproduction, whole or in part, disclosure to third parties or use of its contents is prohibited without the prior written consent of Free2move eSolutions S.p.A.

Any information in this manual may be changed without prior notice and does not represent any obligation on the part of the manufacturer. Images in this manual are for illustrative purposes only and might differ from the delivered product.

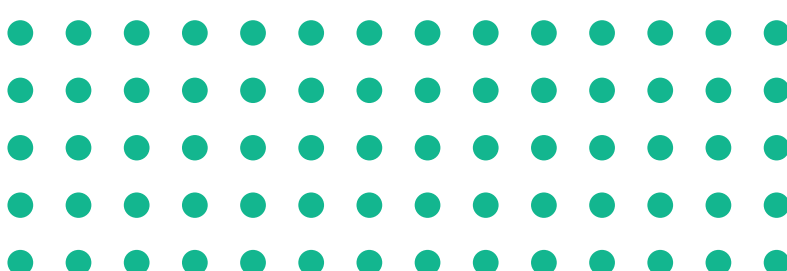

Registered office
Free2move eSolutions S.p.A.
Piazzale Lodi, 3
20137 Milan - Italy
www.esolutions.free2move.com

PL

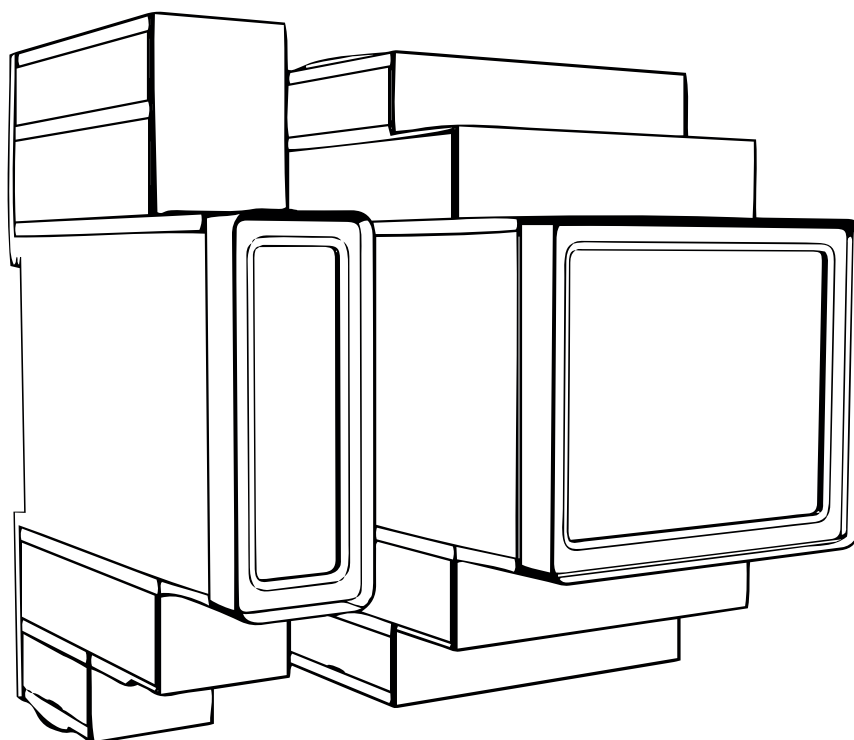

 **LuxWallbox**

Instrukcja dot. akcesoriów



Należy przestrzegać niniejszej instrukcji, aby zapewnić bezpieczne i prawidłowe użytkowanie. Instrukcję należy zachować na przyszłość.

Innholdsfortegnelse

1. WPROWADZENIE.....	4
1.1. Cel instrukcji.....	4
1.2. Identyfikacja producenta	4
1.3. Struktura instrukcji dot. akcesoriów	4
1.4. Bezpieczeństwo	5
1.5. Środki ochrony indywidualnej (ŚOI).....	6
1.6. Gwarancja i warunki dostawy.....	6
1.7. Lista dokumentów	7
1.8. Ostrzeżenia	7
2. INFORMACJE OGÓLNE.....	8
2.1. Obszary zastosowania	9
3. INSTALACJA AKCESORIÓW.....	10
3.1. Instalacja PowerMeter (DPM)	10
3.2. Instalacja MIDcounter.....	15
3.3. Instalacja kabla komunikacyjnego	17
3.4. Łączona instalacja MIDcounter i PowerMeter (DPM)	19
4. Konfiguracja PowerMeter (DPM) i MIDcounter	22
4.1. Modele Finder.....	22
4.2. Modele Gavazzi	24
4.3. Podsumowanie konfiguracji urządzenia	25
4.4. Konfiguracja PowerMeter (DPM) i MIDcounter w aplikacji	26
4.5. Konfiguracja PowerMeter (DPM).....	28
4.6. Konfiguracja MIDcounter	30
5. ROZWIĄZYWANIE PROBLEMÓW.....	31
6. CZYSZCZENIE	37
7. UTYLIZACJA OPAKOWAŃ	37
8. POMOC	37
9. ZRZECZENIE SIĘ ODPOWIEDZIALNOŚCI	37



1. WPROWADZENIE

1.1. Cel instrukcji

Niniejsza instrukcja instalacji stanowi przewodnik dla operatorów, umożliwiającą bezpieczną pracę i wykonywanie podczas instalacji operacji niezbędnych do utrzymania ładowarki w dobrym stanie.

Celem niniejszego dokumentu jest zapewnienie wsparcia dla wykwalifikowanych techników, który przeszli odpowiednie przeszkolenie i wykazali się odpowiednimi umiejętnościami i wiedzą w zakresie budowy, instalacji, obsługi i konserwacji urządzeń elektrycznych.

W przypadku korzystania z ładowarki w sposób inny niż wyszczególniony w niniejszej instrukcji stopień ochrony zapewniany przez ładowarkę może być zmniejszony. Ten dokument zawiera informacje potrzebne do instalacji ładowarki.

Ten dokument został starannie sprawdzony przez producenta, Free2move eSolutions S.p.A., jednak nie można całkowicie wykluczyć przeoczeń. W razie stwierdzenia jakichkolwiek błędów prosimy o poinformowanie Free2move eSolutions S.p.A. Z wyjątkiem zobowiązań wynikających bezpośrednio z umowy firma Free2move eSolutions S.p.A. w żadnych okolicznościach nie może ponosić odpowiedzialności za jakiegokolwiek straty lub szkody wynikające z korzystania z niniejszej instrukcji lub z instalacji wyposażenia. Ten dokument został pierwotnie napisany w języku angielskim. W przypadku jakiegokolwiek niespójności lub wątpliwości należy zwrócić się do firmy Free2move eSolutions S.p.A. o oryginalny dokument.

1.2. Identyfikacja producenta

Producentem ładowarki jest:

Free2move eSolutions S.p.A.

Piazzale Lodi, 3

20137 Mediolan – Włochy

www.esolutions.free2move.com

1.3. Struktura instrukcji dot. akcesoriów





Niniejsza instrukcja jest podzielona na rozdziały, opisujące poszczególne tematy i zawierające wszystkie informacje potrzebne do bezpiecznej instalacji ładowarki.

Każdy rozdział jest dalej podzielony na punkty, opisujące najważniejsze kwestie; każdy punkt może mieć własny tytuł, podtytuły i opis.

1.4. Bezpieczeństwo

Niniejsza instrukcja zawiera ważne informacje dotyczące bezpieczeństwa, których należy przestrzegać podczas instalacji ładowarki.

Z uwagi na to niniejsza instrukcja zawiera szereg tekstów ostrzegawczych, obejmujących specjalne instrukcje. Instrukcje te są oznaczone za pomocą specjalnej ramki z tekstem, obok której znajduje się właściwy symbol zagrożenia i mają na celu zapewnienie bezpieczeństwa personelu, który ma wykonywać opisane czynności, a także uniknięcie wszelkich uszkodzeń ładowarki i/lub mienia:

	<p>Symbol ten oznacza: NIEBEZPIECZEŃSTWO</p> <p>Ten symbol ma na celu zwrócenie uwagi na niebezpieczną sytuację dla użytkownika oraz innych osób. Przeczytaj uważnie. Niezastosowanie się do tej instrukcji spowoduje niebezpieczną sytuację, która — jeśli nie uda się jej uniknąć — doprowadzi do natychmiastowej śmierci lub do poważnych bądź trwałych obrażeń ciała.</p>
	<p>Symbol ten oznacza: OSTRZEŻENIE</p> <p>Ten symbol ma na celu zwrócenie uwagi na informacje dotyczące bezpieczeństwa. Niezastosowanie się do tej instrukcji spowoduje potencjalnie niebezpieczną sytuację, która — jeśli nie uda się jej uniknąć — może doprowadzić do śmierci lub do poważnych obrażeń ciała.</p>
	<p>Symbol ten oznacza: PRZESTROGA</p> <p>Ten symbol ma na celu zwrócenie uwagi na informacje dotyczące bezpieczeństwa. Przeczytaj uważnie. Nieprzestrzeganie tych instrukcji może skutkować śmiercią, poważnymi obrażeniami ciała lub uszkodzeniem sprzętu.</p>
	<p>Symbol ten oznacza: UWAGA</p> <p>Zawiera dodatkowe informacje, uzupełniające podane instrukcje.</p>
	<p>Symbol ten oznacza: INFORMACJA</p> <p>Zawiera instrukcje dotyczące użytkowania lub postępowania, konieczne do wykonania czynności niepowiązanych z możliwymi obrażeniami fizycznymi.</p>

Instalacja musi być przeprowadzana przez wykwalifikowany personel. Musi zostać zaprojektowana i wykonana przeznaczona specjalnie do tego celu, nowoczesna elektryczna instalacja zasilająca; instalacja ta musi posiadać certyfikację zgodnie z lokalnymi przepisami i z umową z dostawcą energii elektrycznej.

Operatorzy są zobowiązani do przeczytania i pełnego zrozumienia niniejszej instrukcji oraz ścisłego przestrzegania zawartych w niej zaleceń.

Firma Free2move eSolutions S.p.A. nie ponosi żadnej odpowiedzialności za szkody dotyczące osób i/lub mienia lub wyposażenia, jeśli warunki opisane w niniejszym dokumencie nie były przestrzegane.





OSTRZEŻENIE: Instalacja musi zostać przeprowadzona zgodnie z przepisami obowiązującymi w kraju instalacji oraz zgodnie ze wszelkimi przepisami dotyczącymi bezpieczeństwa prowadzenia prac elektrycznych.

1.5. Środki ochrony indywidualnej (ŚOI)

Określenie „środki ochrony indywidualnej” (ŚOI) oznacza jakikolwiek sprzęt, który ma być używany przez pracowników w celu zabezpieczenia ich przed możliwymi zagrożeniami dla ich zdrowia lub bezpieczeństwa w miejscu pracy, a także jakiegokolwiek urządzenia lub akcesoria przeznaczone do tego celu.

Ze względu na to, że wszystkie ŚOI wskazane w niniejszej instrukcji mają na celu ochronę personelu przed zagrożeniami dla zdrowia i bezpieczeństwa, producent ładowarki stanowiącej przedmiot niniejszej instrukcji zaleca ściśle przestrzeganie zaleceń podanych w poszczególnych częściach niniejszej instrukcji.

Lista ŚOI, które mają być używane w celu zapewnienia ochrony operatorom przed resztkowym ryzykiem obecnym podczas czynności instalacyjnych i konserwacyjnych opisanych w niniejszej instrukcji jest podana poniżej.

Symbol	Znaczenie
	Nosić rękawice ochronne
	Nosić obuwie antystatyczne



OSTRZEŻENIE: operator jest odpowiedzialny za przeczytanie i zrozumienie lokalnych przepisów oraz ocenę warunków środowiskowych w miejscu instalacji w celu zidentyfikowania potrzeby użycia dodatkowych ŚOI.

1.6. Gwarancja i warunki dostawy

Szczegóły gwarancji są opisane w Warunkach sprzedaży dołączonych do zamówienia dla tego produktu i/lub do opakowania produktu.

Firma Free2move eSolutions S.p.A. nie ponosi żadnej odpowiedzialności w przypadku nieprzestrzegania instrukcji dotyczących prawidłowej instalacji i nie odpowiada za systemy znajdujące się przed lub za dostarczonym wyposażeniem.

Firma Free2move eSolutions S.p.A. nie ponosi odpowiedzialności za wady lub nieprawidłowe działanie wynikające z: nieprawidłowego używania ładowarki; pogorszenia stanu w wyniku transportu, szczególnych warunków otoczenia lub instalacji przeprowadzonej przez niewykwalifikowane osoby.

Free2move eSolutions S.p.A. nie ponosi odpowiedzialności za żadną utylizację sprzętu lub jego części, która nie jest zgodna z przepisami i prawami obowiązującymi w kraju instalacji.



INFORMACJA: jakiegokolwiek modyfikacje, manipulacje lub zmiany dotyczące sprzętu bądź oprogramowania, które nie zostały wyraźnie uzgodnione z producentem, spowodują natychmiastowe unieważnienie gwarancji.

1.7. Lista dokumentów

Oprócz tej instrukcji dokumentację produktu można wyświetlić i pobrać, odwiedzając stronę internetową: www.esolutions.free2move.com.

1.8. Ostrzeżenia



NIEBEZPIECZEŃSTWO: ryzyko porażenia prądem elektrycznym i pożaru. Instalacja musi zostać przeprowadzona zgodnie z przepisami obowiązującymi w kraju instalacji oraz zgodnie ze wszelkimi przepisami dotyczącymi bezpieczeństwa prowadzenia prac elektrycznych.

- Przed instalacją lub użyciem urządzenia należy się upewnić, że żaden z elementów nie został uszkodzony. Uszkodzone elementy mogą prowadzić do porażenia prądem, powstania zwarć i pożaru z powodu przegrzania. Nie wolno używać urządzenia z uszkodzeniem lub wadami.
- Urządzenie **eLuxWallbox** należy instalować z dala od pojemników z benzyną lub innych substancji palnych.
- Przed zainstalowaniem **akcesoriów kompatybilnych z urządzeniem eLuxWallbox** należy się upewnić, że główne źródło zasilania zostało odłączone.
- **Akcesoria kompatybilne z urządzeniem eLuxWallbox** mogą być używane wyłącznie do określonych zastosowań, zgodnie z ich przeznaczeniem.
- Nieprawidłowo przeprowadzona instalacja może stwarzać ryzyko dla użytkownika.
- Ładowarka musi być podłączona do sieci elektrycznej zgodnie z lokalnymi i międzynarodowymi normami oraz wszystkimi wymaganiami technicznymi wskazanymi w niniejszej instrukcji.
- Dzieci lub inne osoby, które nie są w stanie ocenić ryzyka związanego z instalacją ładowarki, mogą doznać poważnych obrażeń ciała lub narazić swoje życie na niebezpieczeństwo.
- Zwierzęta domowe lub inne zwierzęta należy trzymać z dala od urządzenia i materiałów opakowaniowych.
- Dzieci nie mogą bawić się urządzeniem, akcesoriami ani opakowaniem dostarczonym z produktem.
- Jedyną częścią, którą można odłączyć od urządzenia **eLuxWallbox** jest zdejmowana pokrywa. Czynności pod pokrywą urządzenia może wykonywać wyłącznie wykwalifikowany personel podczas instalacji, demontażu lub konserwacji.
- Urządzenie **eLuxWallbox** może być używane tylko ze źródłem energii.
- Należy podjąć niezbędne środki ostrożności w celu zapewnienia bezpieczeństwa działania z aktywnymi wszczepianymi wyrobami medycznymi. Aby ustalić, czy proces ładowania może niekorzystnie wpłynąć na wyrób medyczny, należy skontaktować się z jego producentem.

2. INFORMACJE OGÓLNE

Urządzenie **eLuxWallbox** to rozwiązanie do ładowania prądem przemiennym do zasilania pojazdów elektrycznych i pojazdów hybrydowych typu plug-in, idealne do użytku półpublicznego i domowego. Ładowarka jest dostępna w konfiguracji trójfazowej lub jednofazowej i wyposażona jest w gniazdo typu 2.

Ładowarka ładuje pojazdy elektryczne do 22 kW w konfiguracji trójfazowej lub do 7,4 kW w konfiguracji jednofazowej. Ładowarka jest wyposażona w opcje łączności, takie jak zdalne monitorowanie z użyciem platformy sterowania eSolutions (CPMS). Końcowa konfiguracja musi zostać przeprowadzona za pomocą aplikacji **PowerUp**. Użytkownik końcowy może zarządzać urządzeniem **eLuxWallbox** za pośrednictwem dedykowanej aplikacji eSolutions Charging. Obie aplikacje są dostępne w sklepach Google Play™ i Apple Store®.

Ta ładowarka jest wyposażona w kartę SIM do połączenia z siecią komórkową 4G.

Karta SIM aktywuje się automatycznie po pierwszym włączeniu ładowarki.

W niniejszym dokumencie opisano sposób instalacji zewnętrznych akcesoriów kompatybilnych z urządzeniem **eLuxWallbox**.

Akcesoria zewnętrzne opisane w niniejszej instrukcji to:

- **PowerMeter (DPM)**: licznik energii, który umożliwia realizację funkcji dynamicznego zarządzania energią (Dynamic Power Management, w skrócie DPM), tj. inteligentnej funkcji, która umożliwia ładowanie pojazdu elektrycznego przy użyciu wyłącznie energii dostępnej w sieci domowej, modulując moc ładowania i unikając niekomfortowych przerw w dostawie energii elektrycznej.
- **MIDcounter**: jest to certyfikowany licznik energii, który pozwala na monitorowanie zużycia energii przez urządzenie **eLuxWallbox** podczas każdej sesji ładowania.

W niniejszej instrukcji zamieszczono opis właściwości różnych akcesoriów, informacje o modelach, procesie instalacji i ostatecznej konfiguracji urządzeń.

Urządzenie **eLuxWallbox** jest skonfigurowane do użytku z następującymi akcesoriami elektrycznymi: **PowerMeter (DPM)** lub **MIDcounter**:

- Gavazzi, wersja 1-fazowa, typu bezpośredniego, 32 A
- Finder, wersja 1-fazowa, typu bezpośredniego, 40 A
- Gavazzi, wersja 3-fazowa, typu bezpośredniego, 65 A
- Finder, wersja 3-fazowa, typu bezpośredniego, 80 A

PowerMeter (DPM):

- Gavazzi, wersja 1-fazowa, typu pośredniego, z 1 x CT, 100 A
- Gavazzi, wersja 1-fazowa, typu pośredniego, z 1 x CTV, 60 A
- Gavazzi, wersja 3-fazowa, typu pośredniego, z 3 x CT, 150 A



OSTRZEŻENIE: nie próbuj instalować akcesoriów elektrycznych, jeśli nie posiadasz uprawnień profesjonalnego elektryka. Może to spowodować poważne niebezpieczeństwo i obrażenia ciała użytkownika oraz innych osób lub zwierząt, a także uszkodzenia mienia w najbliższym otoczeniu.

Do zakończenia instalacji konieczne jest skonfigurowanie urządzenia **eLuxWallbox** za pomocą aplikacji przeznaczonej specjalnie do tego celu:

	Aplikacja dla instalatora: PowerUp
Wersje produktu (UE):	EPRO23S224GWBAX
Wersje produktu (WB):	EPRO23S224GWBAS



OSTRZEŻENIE: kompatybilne są wyłącznie akcesoria elektryczne sugerowane przez firmę Free2move eSolutions S.p.A. Instalacja musi być przeprowadzana przez wykwalifikowany personel zgodnie z lokalnymi przepisami.

2.1. Obszary zastosowania

Free2move eSolutions S.p.A. nie ponosi żadnej odpowiedzialności za jakiegokolwiek szkody spowodowane nieprawidłowymi lub nieostrożnymi działaniami.

Ładowarki nie wolno używać do celów innych niż te, do których jest ona przeznaczona.

Sprzęt nie może być używany przez dzieci ani osoby o ograniczonych zdolnościach umysłowych lub fizycznych, ani też przez osoby dorosłe lub wykwalifikowanych specjalistów, jeśli ładowarka jest poddawana działaniu niezgodnemu z niniejszą instrukcją i towarzyszącą jej dokumentacją.

Ładowarka jest urządzeniem do ładowania pojazdów elektrycznych; jej cechy określa poniższa klasyfikacja (zgodnie z IEC 61851-1):

- Zasilanie: podłączone na stałe do sieci zasilania prądem przemiennym (AC)
- Wyjście: prąd przemienny
- Warunki otoczenia: użytkowanie w pomieszczeniach / na zewnątrz
- Zainstalowane na stałe
- Ochrona przed porażeniem prądem elektrycznym: klasa I
- Klasyfikacja środowiskowa EMC: klasa B
- Typ ładowania: tryb 3 zgodnie z normą IEC 61851-1
- Opcjonalna funkcja wentylacji nie jest obsługiwana

3. INSTALACJA AKCESORIÓW

Aby zainstalować akcesoria elektryczne, konieczne jest używanie kabli komunikacyjnych Modbus o następujących parametrach:

- Modbus RS485 skręcony STP 2x2 AWG24 lub S/FTP kat. 7, odpowiedni do instalacji z linią zasilającą 400 V
- Przekrój żyły: 0,5 mm²
- Długość odstąpienia izolacji: 10 mm
- Zalecana długość maksymalna: 150 m

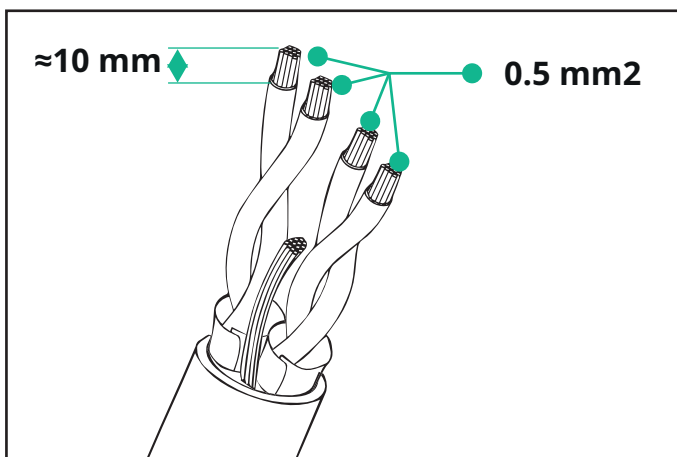

3.1. Instalacja PowerMeter (DPM)

PowerMeter (DPM) jest to licznik energii, który umożliwia realizację funkcji dynamicznego zarządzania energią (Dynamic Power Management, w skrócie DPM), tj. inteligentnej funkcji, która umożliwia ładowanie pojazdu elektrycznego przy użyciu wyłącznie energii dostępnej w sieci domowej, modulując moc ładowania i unikając niekomfortowych przerw w dostawie energii elektrycznej. Jeśli podczas sesji ładowania używane są inne urządzenia, system może modulować moc ładowania w kierunku samochodu, nawet tymczasowo zawieszając sesję ładowania. Tuż po wyłączeniu innych urządzeń domowych sesja zostanie wznowiona.

Inteligentna logika DPM działa w instalacjach zarówno trójfazowych, jak i jednofazowych.



OSTRZEŻENIE: podczas instalacji w systemach trójfazowych należy upewnić się, że obciążenia elektryczne (w tym samo urządzenie wallbox) są dobrze zrównoważone pomiędzy fazami instalacji elektrycznej.



OSTRZEŻENIE: przed wykonaniem jakichkolwiek czynności instalacyjnych lub konserwacyjnych w zakresie urządzenia należy upewnić się, że zasilanie jest wyłączone.

W przypadku modeli Direct PowerMeter (DPM):

Umieść **PowerMeter (DPM)** za głównym licznikiem energii elektrycznej. **PowerMeter (DPM)** musi mierzyć wszystkie obciążenia elektryczne, w tym urządzenia **eLuxWallbox**.

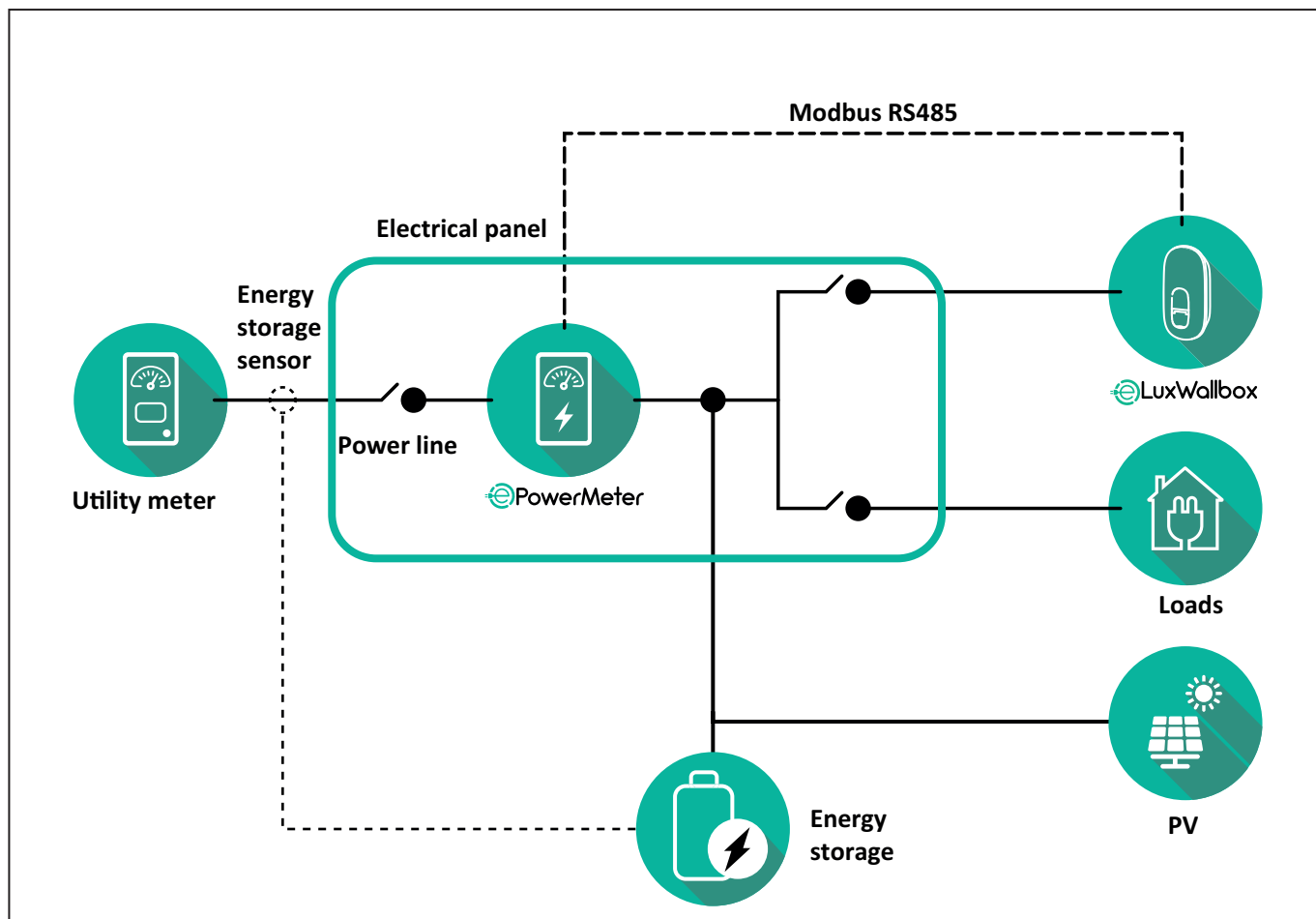

W przypadku modeli Direct PowerMeter:



OSTRZEŻENIE: podczas instalacji zawsze korzystaj z treści instrukcji instalacji producenta dostarczonej wraz z licznikiem.



UWAGA: w przypadku jednofazowego lub trójfazowego przyłącza elektrycznego urządzenia Direct **PowerMeter** zapoznaj się z poniższymi schematami.

Model Finder, wersja 1-fazowa i 3-fazowa

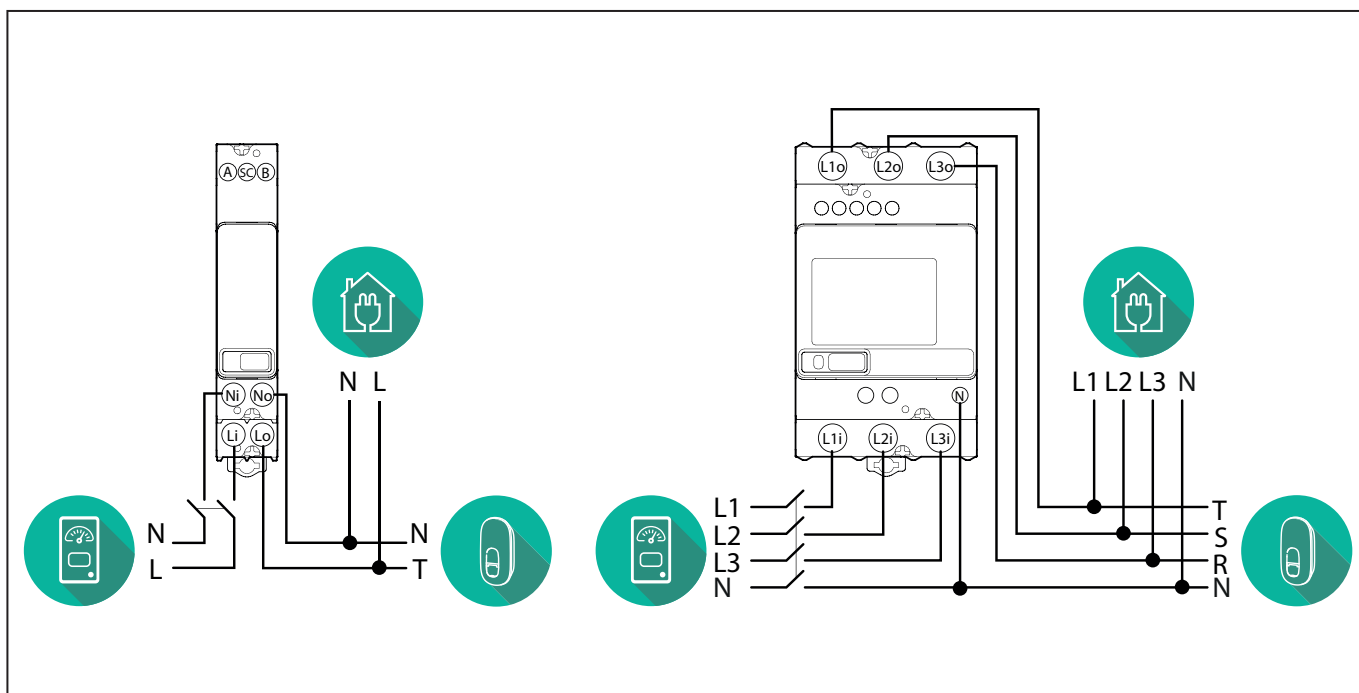

Model Gavazzi, wersja 1-fazowa i 3-fazowa

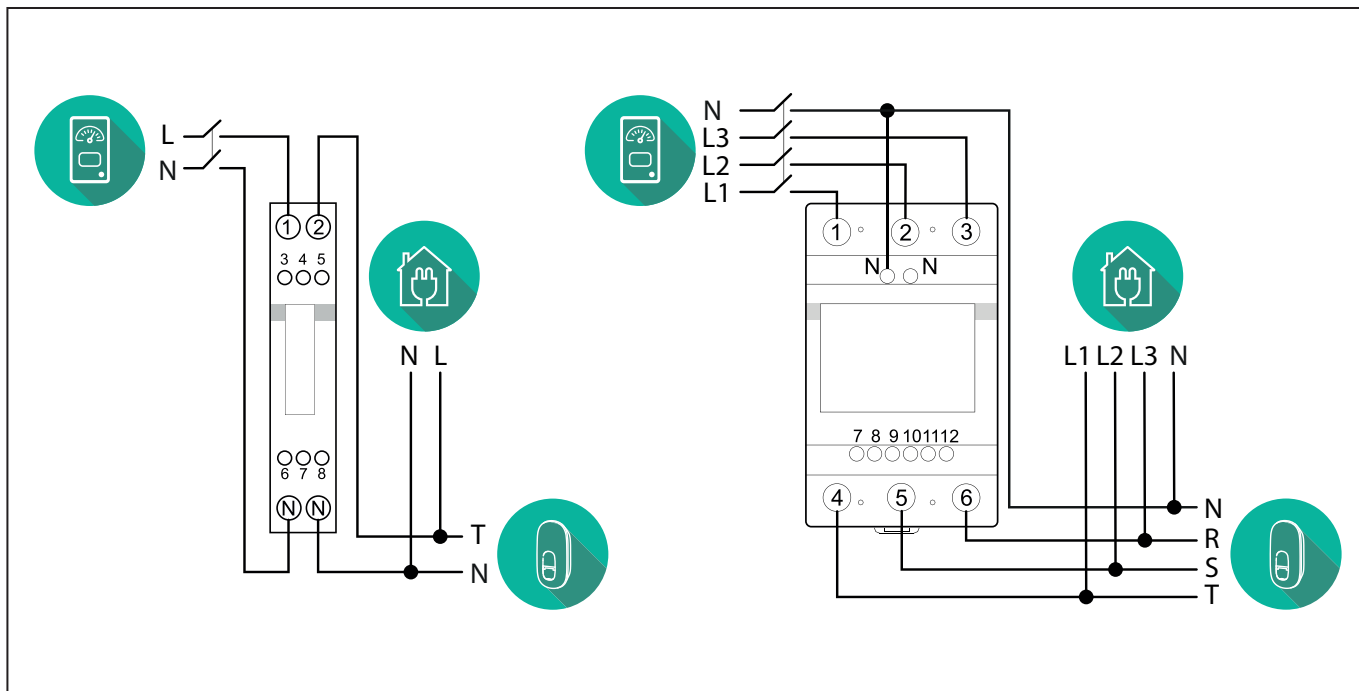

INFORMACJA:



1) Jeśli dostępna jest instalacja fotowoltaiczna, **PowerMeter** należy umieścić między licznikiem energii a punktem przyłącza instalacji fotowoltaicznej.

2) Jeśli dostępny jest system domowego magazynowania energii, **PowerMeter** należy umieścić między punktem przyłącza magazynu energii a czujnikiem pomiaru systemu magazynowania energii.

W przypadku pośrednich modeli PowerMeter:

Umieść CT (przekładnik prądowy) urządzenia **PowerMeter** za głównym licznikiem energii i przed głównym wyłącznikiem domu/budynku. Przekładnik prądowy musi mierzyć wszystkie obciążenia domowe, w tym urządzenia **eLuxWallbox**.

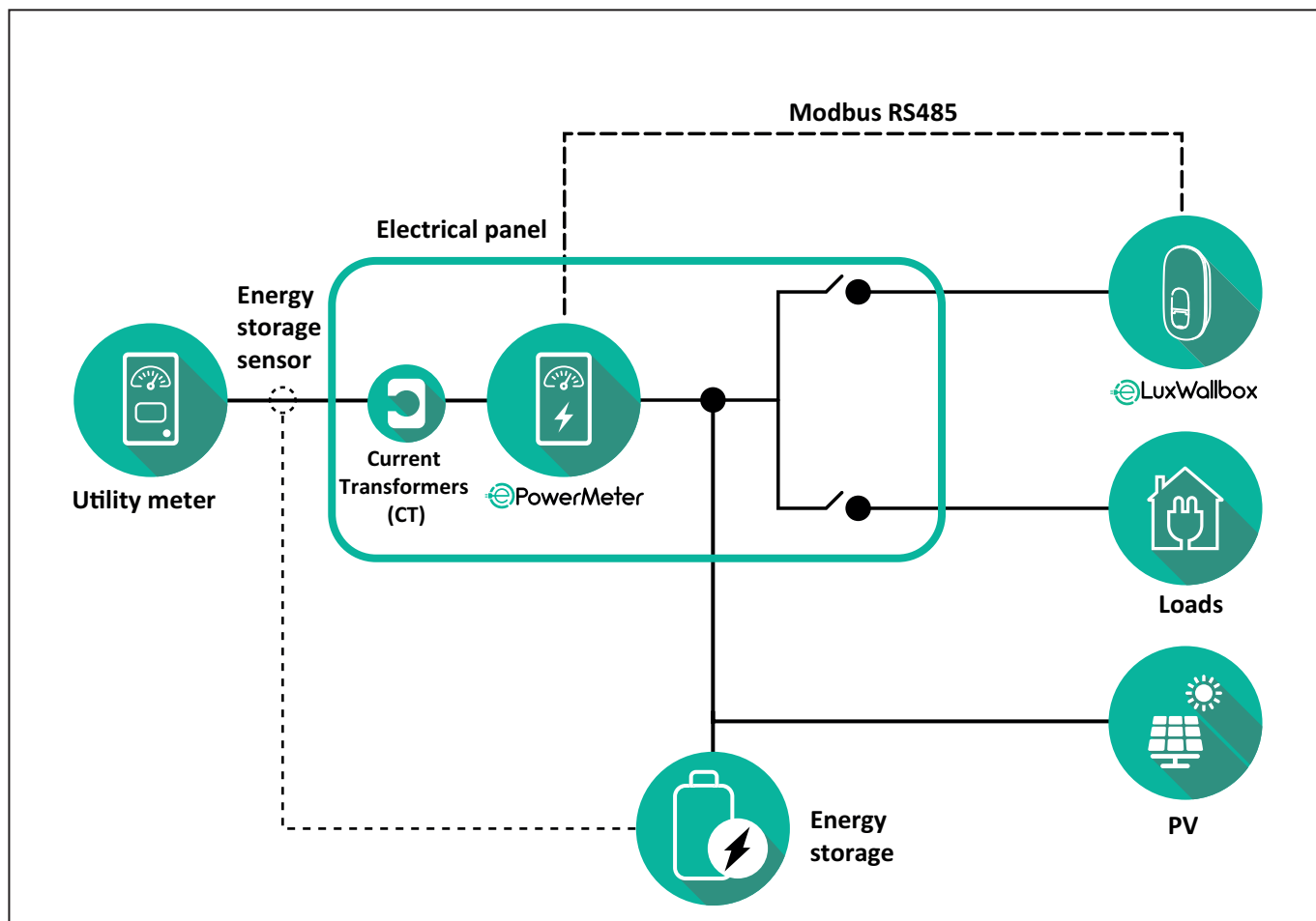

INFORMACJA:



1) Jeśli dostępna jest instalacja fotowoltaiczna, przekładniki prądowe (CT) urządzenia **PowerMeter** należy umieścić między punktem przyłącza instalacji fotowoltaicznej a licznikiem energii.

2) Jeśli dostępny jest system domowego magazynowania energii, przekładniki prądowe (CT) urządzenia **PowerMeter** należy umieścić między punktem przyłącza magazynu energii a czujnikiem pomiaru systemu magazynowania energii.

Przekładniki prądowe (CT) należy podłączyć zgodnie ze wskazówkami w instrukcji instalacji licznika. Strzałkę na przekładniku prądowym należy skierować w kierunku obciążeń.

W przypadku trójfazowego lub jednofazowego przyłącza elektrycznego pośredniego urządzenia **PowerMeter** zapoznaj się z poniższymi schematami.

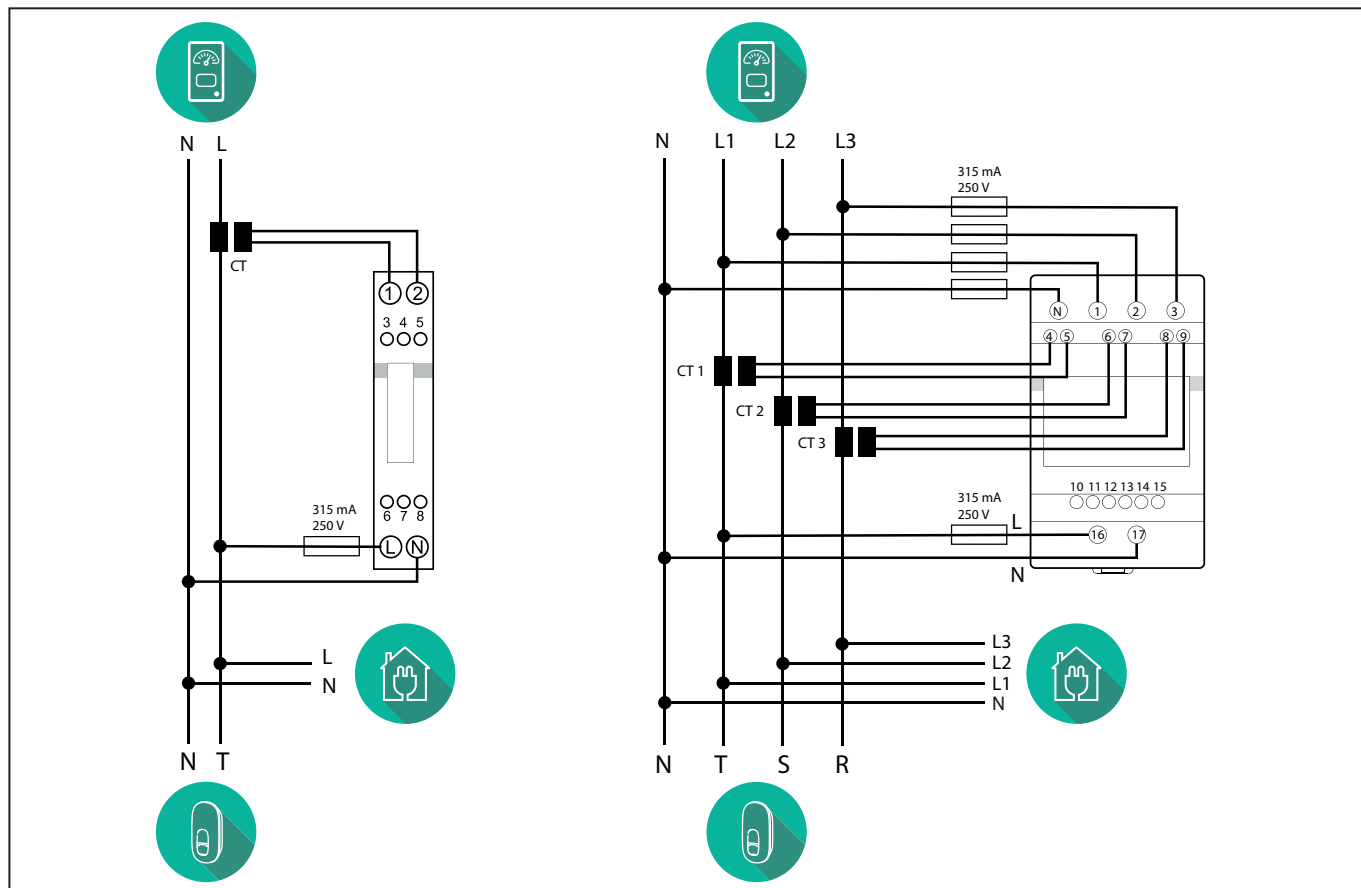

3.2. Instalacja MIDcounter

MIDcounter to certyfikowany licznik energii, który umożliwia bezpieczne i niezawodne monitorowanie zużycia energii ładowarki podczas każdej sesji ładowania.

Wszystkie istotne dane dotyczące sesji ładowania są automatycznie rejestrowane przez certyfikowany licznik MID i przesyłane z ładowarki do systemu zarządzania punktem ładowania (Charge Point Management System, w skrócie CPMS).



OSTRZEŻENIE: podczas tego etapu zasilanie ładowarki musi pozostać wyłączone.

Umieść **MIDcounter** na tej samej linii zasilania co ładowarka, za urządzeniami zabezpieczającymi.

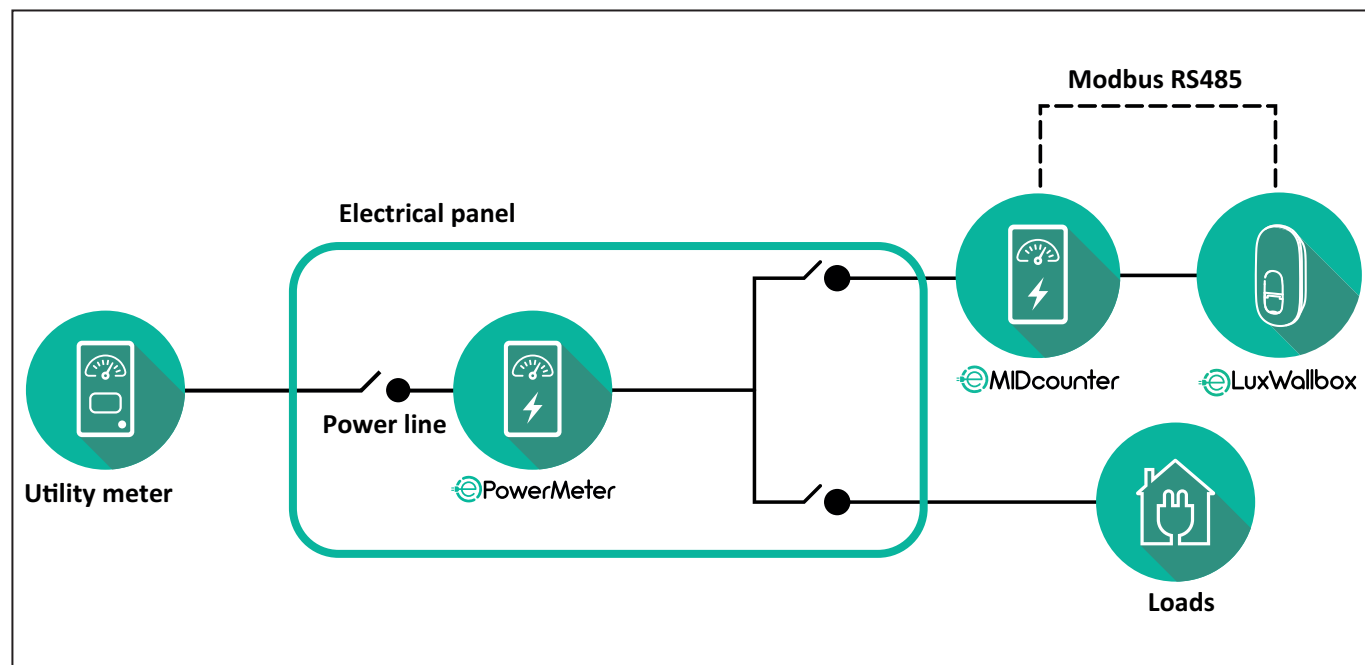

Zapoznaj się z poniższymi schematami dotyczącymi jednofazowego i trójfazowego przyłącza elektrycznego urządzenia **MIDcounter** (Finder i Gavazzi).

Finder, wersja 1-fazowa, typu bezpośredniego, 40 A (7M2482300210)

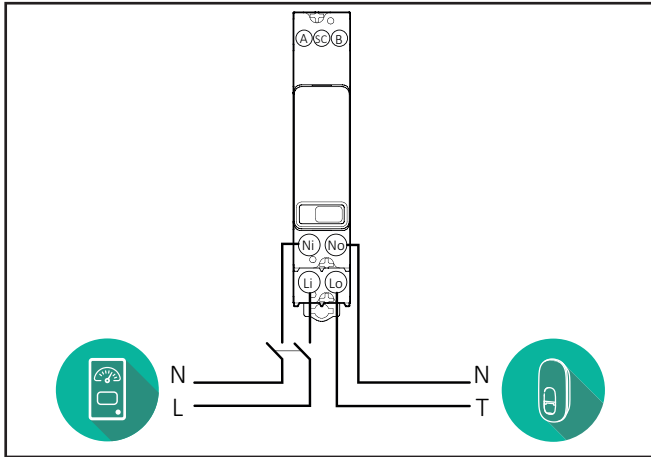

Gavazzi, wersja 3-fazowa, typu bezpośredniego, 65 A (EM340DINAV23XS1PFB)

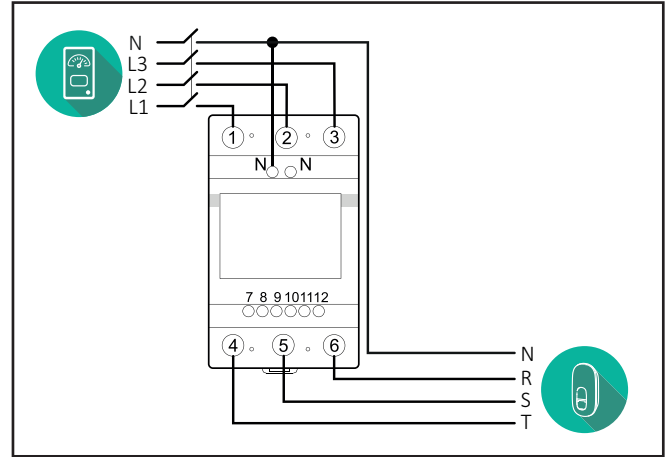

Finder, wersja 3-fazowa, typu bezpośredniego, 80 A (7M3884000212)

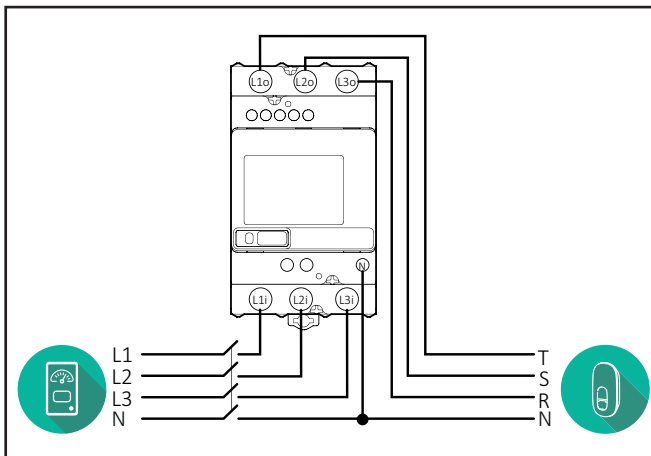

Gavazzi, wersja 1-fazowa, typu bezpośredniego, 100 A (EM112DINAV01XS1PFB)

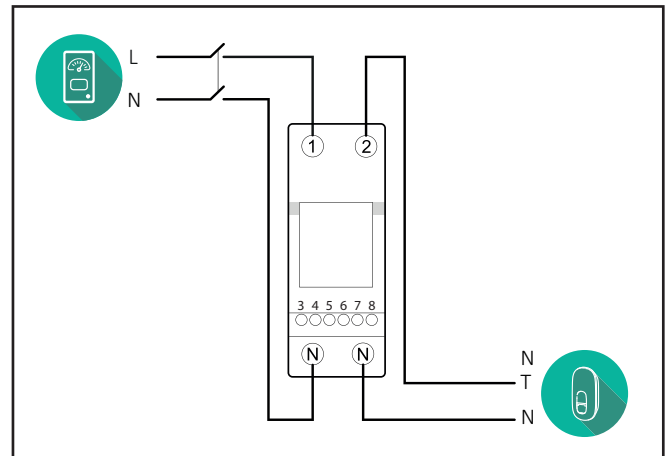

Gavazzi, wersja 1-fazowa, typu bezpośredniego, 32 A (EM111DINAV81XS1PFB)

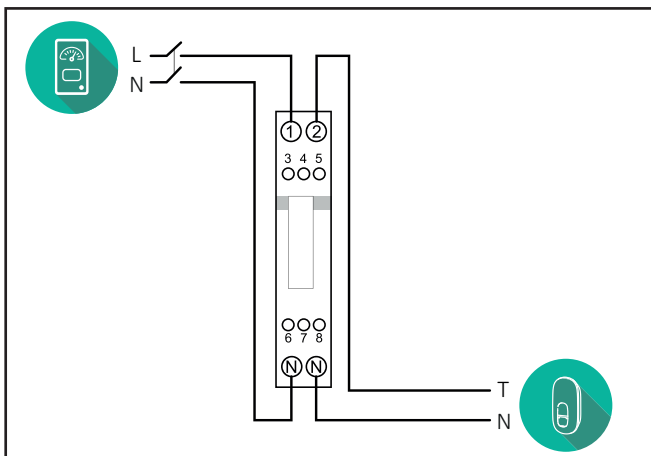

3.3. Instalacja kabla komunikacyjnego

Zainstaluj kabel komunikacyjny pomiędzy **PowerMeter (DPM)** i **eLuxWallbox**.

- W urządzeniu **eLuxWallbox** zdejmij zaślepkę zabezpieczającą z punktu wejścia kabli komunikacyjnych i włóż osłonę falistą \varnothing 25 mm.
- Dokręć połączenie płaszczka kablowego z obudową.
- Włóż kabel komunikacyjny, wyciągając go na odpowiednią długość, aby można było dotrzeć do portu komunikacyjnego CN12 z pozostawieniem niewielkiego luzu.
- Podłącz kabel komunikacyjny Modbus RS485 do GND, styki - i + złącza CN12.



UWAGA: można zastąpić połączenia płaszczka kablowego z obudową przepustami kablowymi \varnothing 25 mm (niedostarczane przez producenta).

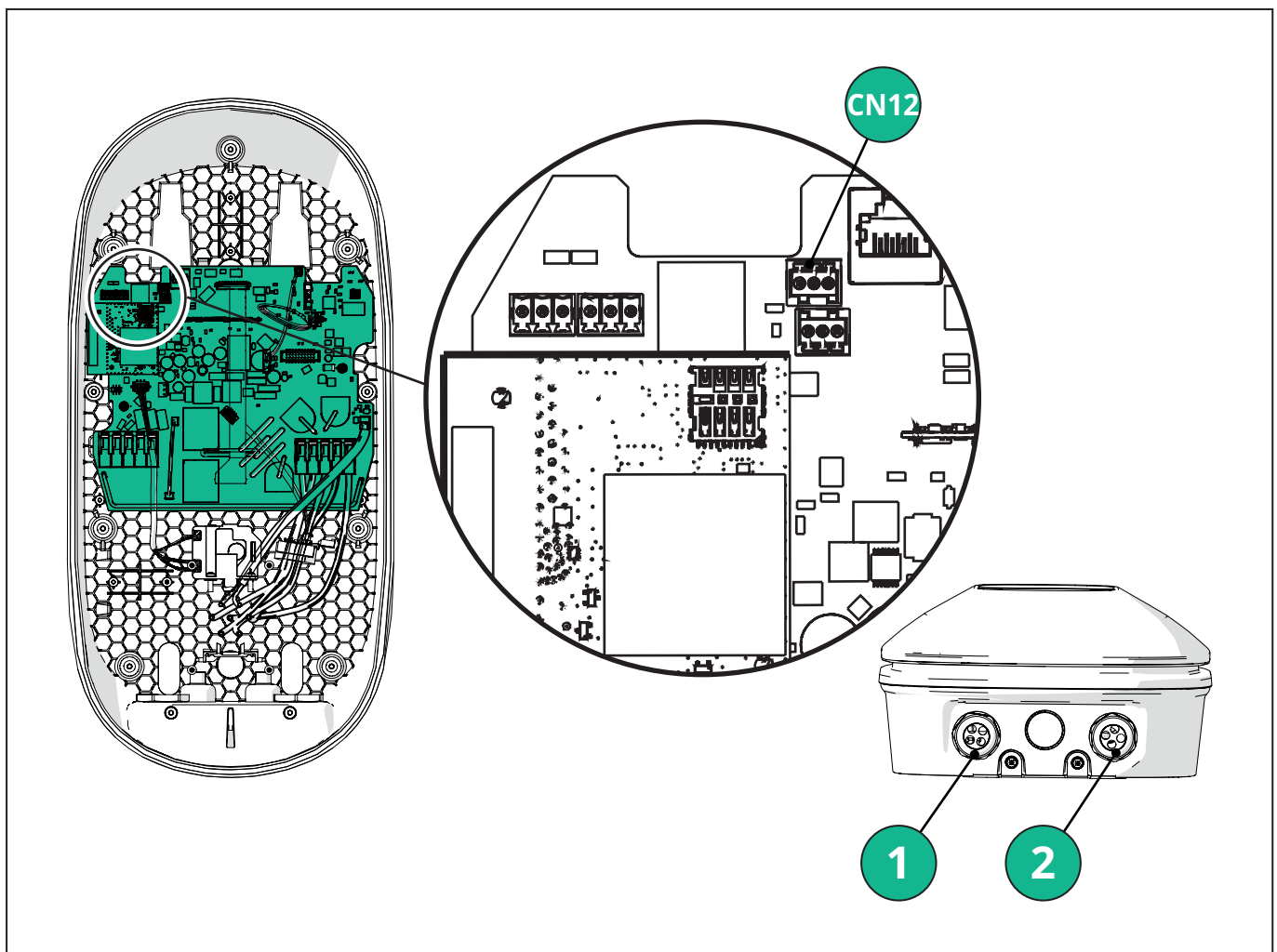

1 - Kable zasilania elektrycznego

2 - Kable komunikacyjne

CN12 - RS485 Modbus do zewnętrznego licznika (DPM i MID)

Podłącz kable komunikacyjne od **PowerMeter (DPM)** do **eLuxWallbox** zgodnie z przedstawioną poniżej kolejnością.



OSTRZEŻENIE: jeśli instalacja przewiduje oba akcesoria, postępuj zgodnie z instrukcjami dotyczącymi „Łączonej instalacji MIDcounter i PowerMeter (DPM)”.

CN12	Finder typu 1-fazowego 7M.24.8.230.0210
GND	SC
-	B
+	A

CN12	Gavazzi typu 3-fazowego EM340DINAV23XS1PFB
GND	10
-	9
+	8

Złącze 9/7

CN12	Finder typu 3-fazowego 7M.38.8.400.0212
GND	SC
-	B
+	A

CN12	Gavazzi Ind typu 1-fazowego EM111DINAV51XS1X / EM111DINMV51XS1X
GND	7
-	8
+	6

Złącze 8/5

CN12	Gavazzi typu 1-fazowego EM111DINAV81XS1PFB
GND	7
-	8
+	6

Złącze 8/5

CN12	Gavazzi Ind typu 3-fazowego EM330DINAV53HS1X
GND	13
-	12
+	11

Złącze 12/10

3.4. Łączona instalacja MIDcounter i PowerMeter (DPM)

W przypadku instalacji obu akcesoriów elektrycznych pozycję urządzenia **MIDcounter** wraz z urządzeniem **PowerMeter (DPM)** wskazano na poniższym schemacie:

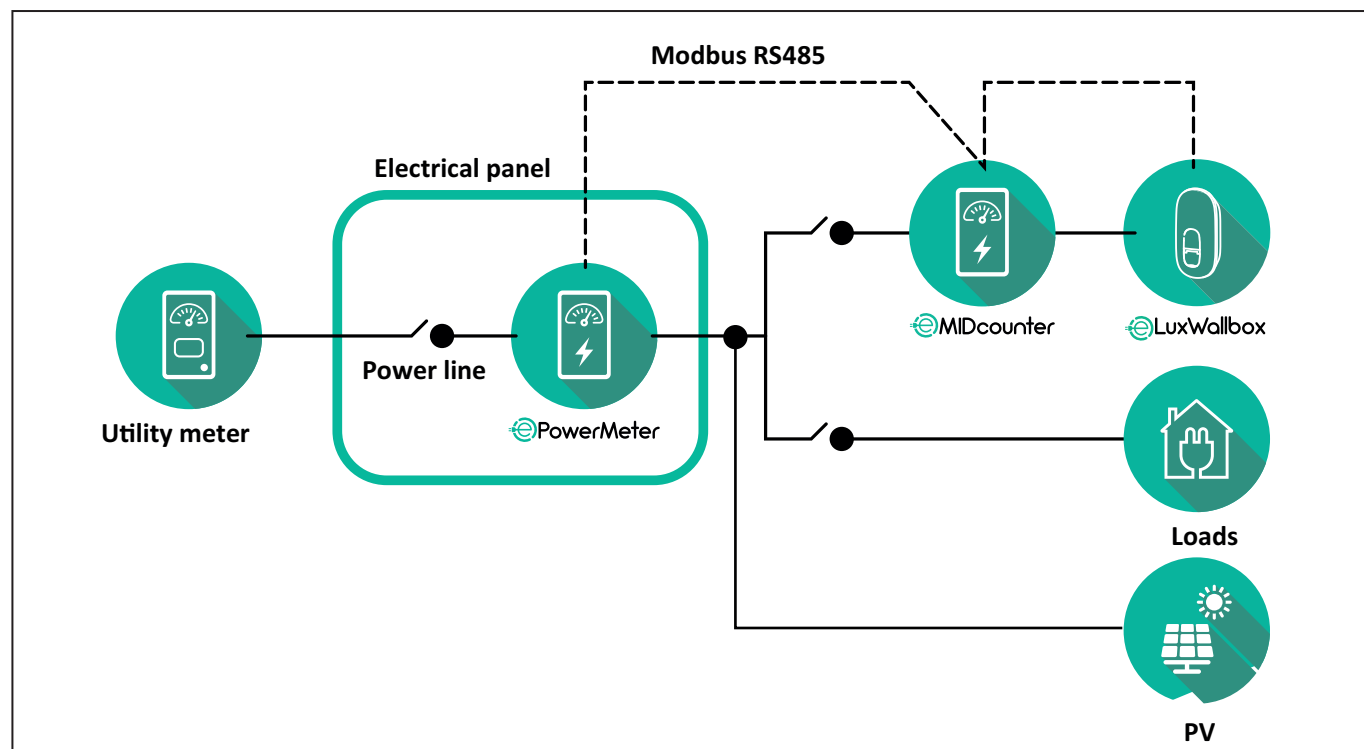

Podłącz kable komunikacyjne Modbus. **PowerMeter (DPM)**, **MIDcounter** i **eLuxWallbox** muszą być podłączone do tej samej magistrali komunikacyjnej w formie łańcuchowym (Daisy Chain).

W **eLuxWallbox**:

- Zdejmij zaślepkę zabezpieczającą z punktu wejścia kabla komunikacyjnego i włóż osłonę falistą $\varnothing 25$ mm.
- Dokręć połączenie płaszczka kablowego z obudową.
- Włóż kabel komunikacyjny, wyciągając go na odpowiednią długość, aby można było dosięgnąć do portu komunikacyjnego CN12 z pozostawieniem niewielkiego luzu.
- Podłącz kabel komunikacyjny Modbus RS485 do GND, styki - i + złącza CN12.

Aby podłączyć kable komunikacyjne od akcesoriów do urządzenia **eLuxWallbox**, skorzystaj z poniższej tabeli.

Wersja jednofazowa.

PowerMeter (DPM)	MIDcounter	eLuxWallbox
EM111DINAV51XS1X - EM111DINMV51XS1X	EM111DINAV81XS1PFB	CN12
GND (7)	GND (7)	GND
A- (8) / T*(5)	A- (8)	-
B+ (6)	B+ (6)	+
EM111DINAV51XS1X - EM111DINMV51XS1X	7M 24.8.230.0210	CN12
GND (7)	SC	GND
A-(8) / T*(5)	B-	-
B+ (6)	A+	+
EM111DINAV81XS1PFB	EM111DINAV81XS1PFB	CN12
GND (7)	GND (7)	GND
A-(8) / T*(5)	A- (8)	-
B+ (6)	B+ (6)	+
EM111DINAV81XS1PFB	7M 24.8.230.0210	CN12
GND (7)	SC	GND
A-(8) / T*(5)	B-	-
B+ (6)	A+	+
7M 24.8.230.0210	EM111DINAV81XS1PFB	CN12
SC	GND (7)	GND
B-	A- (8)	-
A+	B+ (6)	+
7M 24.8.230.0210	7M 24.8.230.0210	CN12
SC	SC	GND
B-	B-	-
A+	A+	+

Wersja trójfazowa.

PowerMeter (DPM)	MIDcounter	eLuxWallbox
EM330DINAV53HS1X	EM340DINAV23XS1PFB	CN12
GND (13)	GND (10)	GND
A-(12) / T*(10)	A-(9)	-
B+ (11)	B+ (8)	+
EM330DINAV53HS1X	7M.38.8.400.0212	CN12
GND (13)	SC	GND
A-(12) / T*(10)	B-	-
B+ (11)	A+	+
EM340DINAV23XS1PFB	EM340DINAV23XS1PFB	CN12
GND (10)	GND (10)	GND
A-(9) / T*(7)	A-(9)	-
B+ (8)	B+ (8)	+
EM340DINAV23XS1PFB	7M.38.8.400.0212	CN12
GND (10)	SC	GND
A-(9) / T*(7)	B-	-
B+ (8)	A+	+
7M.38.8.400.0212	EM340DINAV23XS1PFB	CN12
SC	GND (10)	GND
B-	A-(9)	-
A+	B+ (8)	+
7M.38.8.400.0212	7M.38.8.400.0212	CN12
SC	SC	GND
B-	B-	-
A+	A+	+

*Rezystor końcowy 120 Ω musi być zainstalowany w urządzeniach na końcach łańcucha Modbus. Domyślnie w urządzeniu **eLuxWallbox** rezystor taki jest obecny. Modele Gavazzi mają wbudowany rezystor, który można włączyć poprzez wykonanie zworki między tymi zaciskami.

4. Konfiguracja PowerMeter (DPM) i MIDcounter

Zasilanie urządzeń **PowerMeter (DPM)** i/lub **MIDcounter** włącz po zakończeniu instalacji elektrycznej i instalacji magistrali komunikacyjnej. Następnie przejdź do etapu konfiguracji przeprowadzanego na wyświetlaczach liczników.

Konfiguracja przebiega w zależności od danego modelu.

4.1. Modele Finder

Poniższe czynności pomagają zrozumieć, jak powinny być ustawione liczniki energii Finder:

- Aby poruszać się między menu i parametrami, naciskaj przycisk ekranu dotykowego (a, b);
- Naciśnij przycisk ekranu dotykowego (a, b) i przytrzymaj go (ok. 2 s), aby wprowadzić i potwierdzić wybór

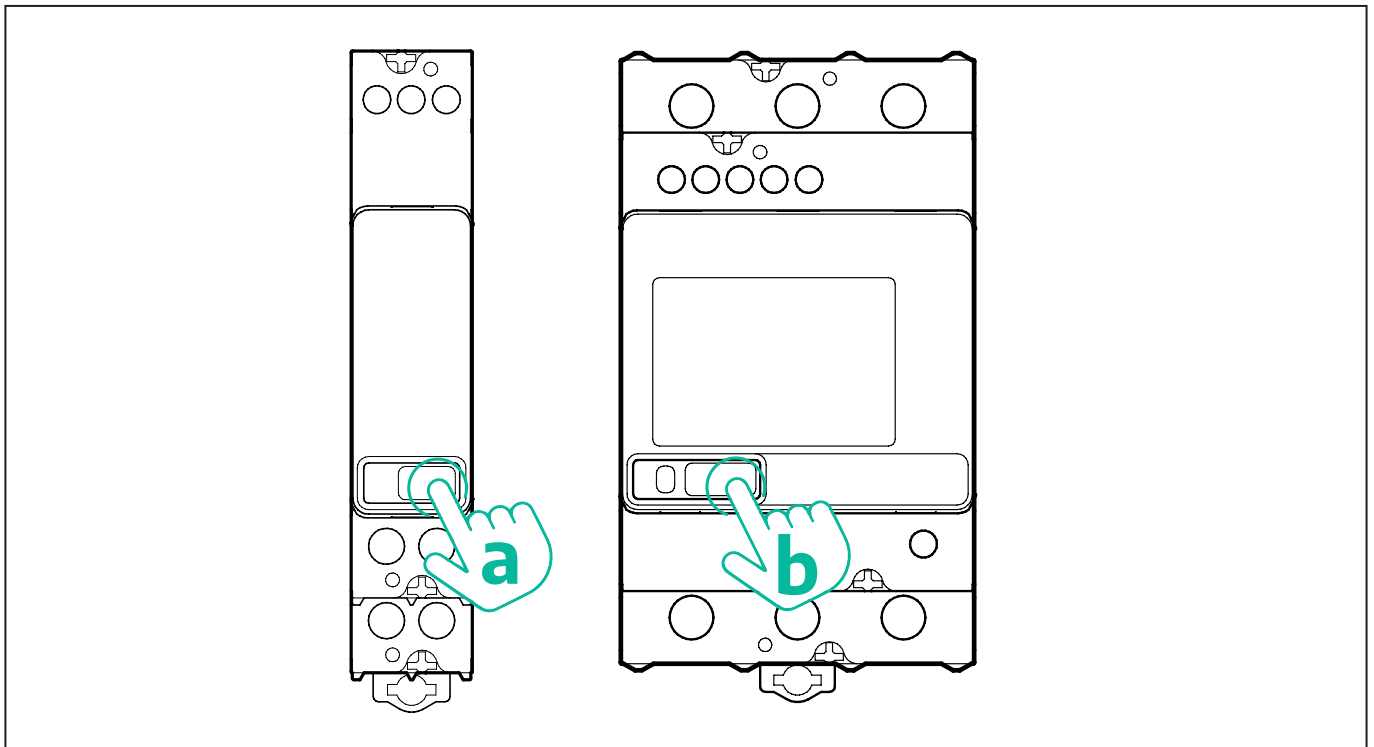

Aby poprawnie skonfigurować jednofazowe lub trójfazowe liczniki energii Finder, wykonaj następujące czynności:

- Podczas pierwszego uruchamiania licznika energii naciśnij dłużej przycisk ekranu dotykowego (a, b), dopóki tekst na wyświetlaczu nie zacznie migać, aby przejść do menu „MAIN”;
- Przewiń menu „MAIN”, naciskając przycisk ekranu dotykowego (a, b), a następnie wybierz „SETTING” („SET” w przypadku licznika jednofazowego). Naciśnij i przytrzymaj przycisk, aby wprowadzić wybór.
- Przewiń menu „SETTING”, naciskając przycisk ekranu dotykowego (a, b), a następnie wybierz „COMMUNICATION” („COMM” w przypadku licznika jednofazowego). Naciśnij i przytrzymaj przycisk, aby wprowadzić wybór.
- Wprowadź prawidłowe wartości podane w poniższej tabeli. Aby zmienić wartość, naciśnij przycisk ekranu dotykowego (a, b), a żeby potwierdzić, naciśnij i przytrzymaj go dłużej.

Tylko w przypadku licznika trójfazowego Finder (dodatkowo do poprzednich opcji):

- Naciśnij i przytrzymaj przycisk ekranu dotykowego (a, b), dopóki tekst na wyświetlaczu nie zacznie migać, aby wejść do menu „MAIN” (lub powrócić do menu „MAIN”)
- Przewiń menu „MAIN”, naciskając przycisk ekranu dotykowego (a, b), a następnie wybierz „INSTALLATION”. Naciśnij i przytrzymaj przycisk ekranu dotykowego (a, b), aby wprowadzić wybraną wartość
- Przewiń menu „INSTALLATION”, naciskając przycisk ekranu dotykowego (a, b), a następnie wybierz następującą opcję
 - „Communication mode” = „3L+N, L+N-Arithmetic”
 - Po potwierdzeniu prawidłowej opcji wprowadź hasło: „DCBA” **Uwaga:** po wprowadzeniu hasła **DCBA** konfiguracji nie można już zmienić.
 - Potwierdź zmianę, wybierając „Yes” po pojawieniu się monitu.

WSZYSTKIE MODELE FINDER	PowerMeter (DPM)	MIDcounter
ADRES URZĄDZENIA	1	2
BITY NA SEKUNDĘ (BOD)	38400 bitów/s	38400 bitów/s
PARZYSTOŚĆ	Typu parzystego	Typu parzystego
BIT STOPU	1	1
Dodatkowo w przypadku typu trójfazowego		
	PowerMeter (DPM)	MIDcounter
TRYB KOMUNIKACJI	3 L + N, L + N – typu arytmetycznego	3 L + N, L + N – typu arytmetycznego
HASŁO	DCBA	DCBA

4.2. Modele Gavazzi

Poniższe czynności pomagają zrozumieć, jak powinny być ustawione liczniki energii Gavazzi:

- Aby poruszać się między poszczególnymi menu i wartościami, naciskaj przyciski ekranu dotykowego (c, d, e, g)
- Naciśnij przycisk ekranu dotykowego (d, f) i przytrzymaj go (ok. 2 s), aby wejść do menu i potwierdzić wybór

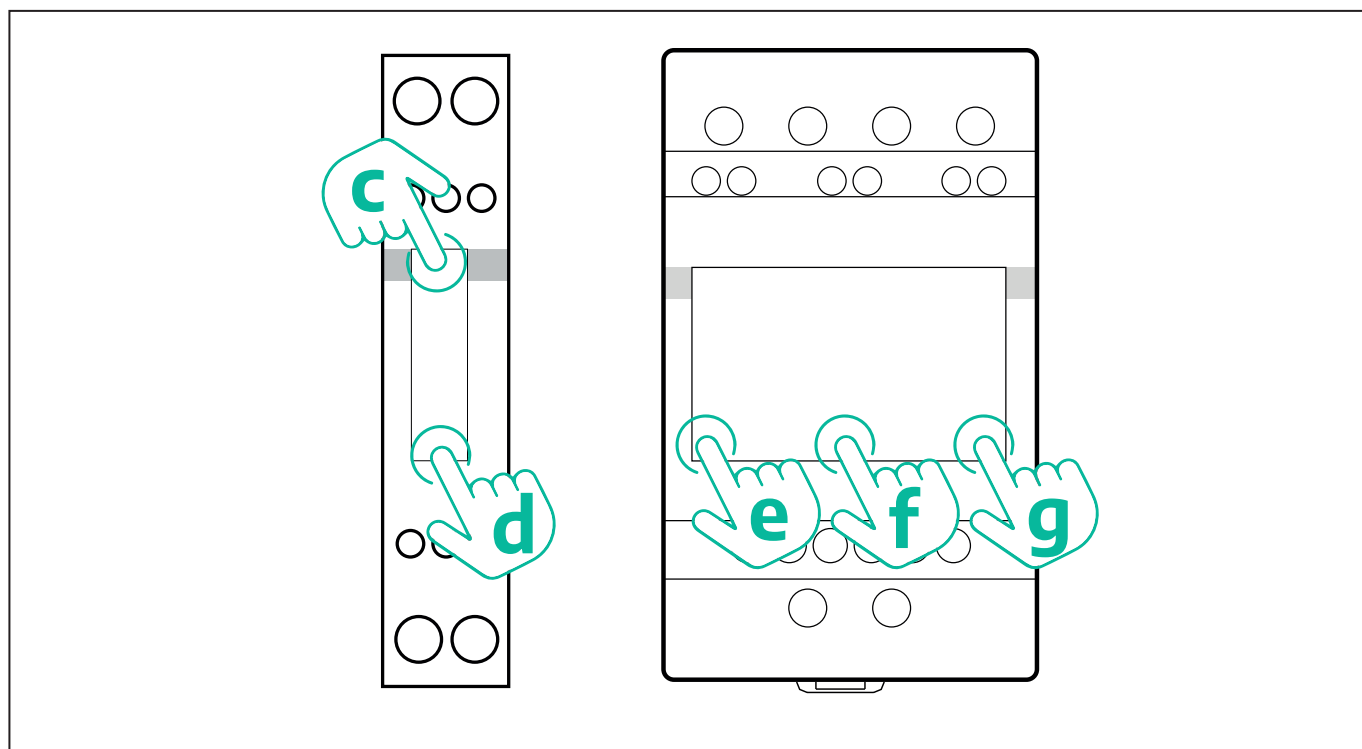

Aby poprawnie skonfigurować jednofazowe bezpośrednie i pośrednie liczniki energii Gavazzi, wykonaj następujące czynności.

- Podczas pierwszego uruchamiania licznika energii naciśnij i przytrzymaj przycisk ekranu dotykowego (d), dopóki na ekranie nie pojawi się hasło
- Naciśnij dłużej jednocześnie przyciski (c, d), aby potwierdzić hasło „0000” i wejść do menu „MAIN”
- Przewiń menu „MAIN”, naciskając górny przycisk (c), a następnie wybierz następujące opcje widniejące w poniższej tabeli

Aby poprawnie skonfigurować trójfazowe bezpośrednie i pośrednie liczniki energii Gavazzi, wykonaj następujące czynności:

- Podczas pierwszego uruchamiania licznika energii naciśnij i przytrzymaj środkowy przycisk (f), dopóki na ekranie nie pojawi się hasło;
- Naciśnij dłużej jednocześnie przyciski (e, g), aby potwierdzić hasło „0000” i wejść do menu „MAIN”
- Przewiń menu „MAIN” naciskając przyciski (e lub g), a następnie wybierz opcje z poniższej tabeli

WSZYSTKIE MODELE GAVAZZI	PowerMeter (DPM)	MIDcounter
HASŁO	0000	0000
ADRES	001	002
BOD	38,4	38,4
PARZYSTOŚĆ	Typu parzystego	Typu parzystego
Dodatkowo w przypadku typu trójfazowego		
SYSTEM	3Pn	3Pn
ADRES	001	002

4.3. Podsumowanie konfiguracji urządzenia

EM340DINAV23XS1PFB / EM330DINAV53HS1X	
HASŁO	0000
SYSTEM	3Pn
ADRES	1
BOD	38,4
PARZYSTOŚĆ	TYPY PARZYSTEGO

EM111DINAV81XS1PFB / EM111DINAV51XS1X / EM111DINMV51XS1X	
HASŁO	0000
ADRES	001
BOD	38,4
PARZYSTOŚĆ	TYPY PARZYSTEGO

7M 24.8.230.0210	
ADRES URZĄDZENIA	__ 1
BITY NA SEKUNDĘ (BOD)	38400 bitów/s
PARZYSTOŚĆ	TYPY PARZYSTEGO
BIT STOPU	1

7M.38.8.400.0212	
ADRES URZĄDZENIA	__ 1
BITY NA SEKUNDĘ (BOD)	38400 bitów/s
PARZYSTOŚĆ	TYPY PARZYSTEGO
BIT STOPU	1
TRYB ŁĄCZNOŚCI	3 L + N, L + N - typu arytmetycznego
HASŁO	DCBA

EM340DINAV23XS1PFB	
HASŁO	0000
SYSTEM	3Pn
ADRES	2
BOD	38,4
PARZYSTOŚĆ	TYPY PARZYSTEGO

EM111DINAV81XS1PFB	
HASŁO	0000
ADRES	002
BOD	38,4
PARZYSTOŚĆ	TYPY PARZYSTEGO

7M 24.8.230.0210	
ADRES URZĄDZENIA	__ 2
BITY NA SEKUNDĘ (BOD)	38400 bitów/s
PARZYSTOŚĆ	TYPY PARZYSTEGO
BIT STOPU	1

7M.38.8.400.0212	
ADRES URZĄDZENIA	__ 2
BITY NA SEKUNDĘ (BOD)	38400 bitów/s
PARZYSTOŚĆ	TYPY PARZYSTEGO
BIT STOPU	1
TRYB ŁĄCZNOŚCI	3 L + N, L + N - typu arytmetycznego
HASŁO	DCBA

4.4. Konfiguracja PowerMeter (DPM) i MIDcounter w aplikacji

Aby zakończyć instalację, ostateczną konfigurację urządzenia **eLuxWallbox** i jego akcesoriów należy przeprowadzić za pośrednictwem dedykowanej aplikacji

PowerUp to aplikacja na smartfon tylko dla wykwalifikowanych instalatorów; jest dostępna w sklepach Google Play™ i Apple Store®. Konfiguracja odbywa się poprzez połączenie Bluetooth. Urządzenie Wallbox nie będzie działało prawidłowo, jeśli nie zostanie skonfigurowane za pośrednictwem aplikacji.



INFORMACJA: Należy się upewnić, że używana jest najnowsza wersja aplikacji PowerUp, aby dysponować dostępem do wszystkich funkcji.

Aby rozpocząć korzystanie z aplikacji, postępuj zgodnie z poniższymi instrukcjami:

Pobierz aplikację PowerUp na swojego smartfona i uruchom na smartfonie tryb Bluetooth.



Zeskanuj kod QR urządzenia **eLuxWallbox**, aby sparować je z aplikacją. Kod QR znajduje się na bocznej części ładowarki.



Po sparowaniu dokończ konfigurację urządzenia **eLuxWallbox** i jego akcesoriów, klikając w dany parametr do skonfigurowania.

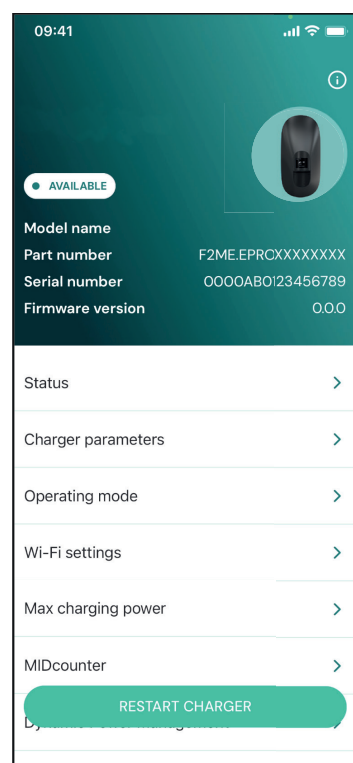

4.5. Konfiguracja PowerMeter (DPM)

Aby zakończyć instalację urządzenia **PowerMeter (DPM)**, wykonaj poniższe czynności:

Wybierz „**DPM PowerMeter**” na stronie głównej

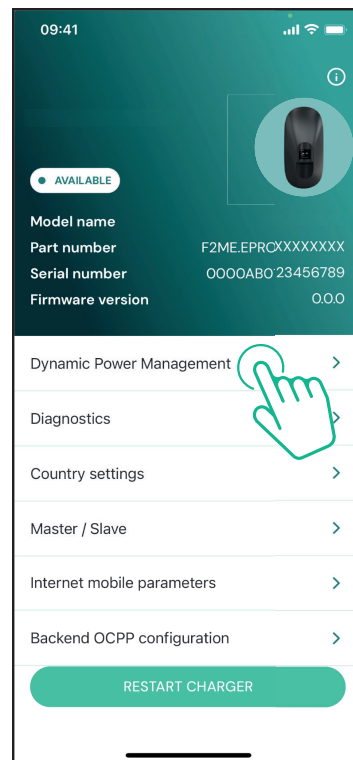

Wybierz typ urządzenia **PowerMeter** z menu rozwijanego, zgodnie z zainstalowanym modelem.

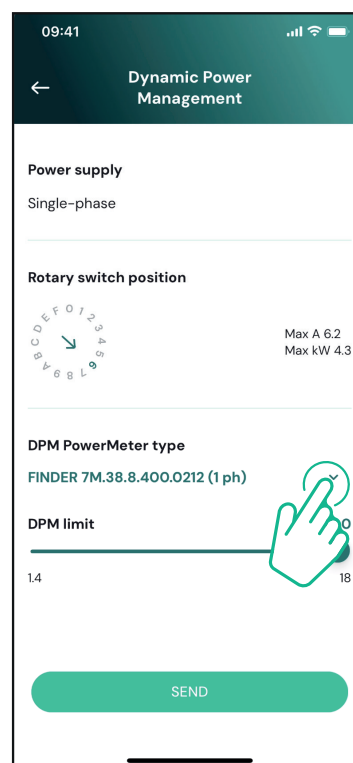

Wprowadź wartość mocy zgodnie z umową użytkownika jako limit mocy DPM.

Tylko w przypadku licznika pośredniego — ustaw przekładnię prądową CT za pomocą suwaka.

- W przypadku CTV 60 A ustaw jako przekładnię prądową wartość 60
- W przypadku CTA 100 A ustaw jako przekładnię prądową wartość 20
- W przypadku CTA 150 A ustaw jako przekładnię prądową wartość 30

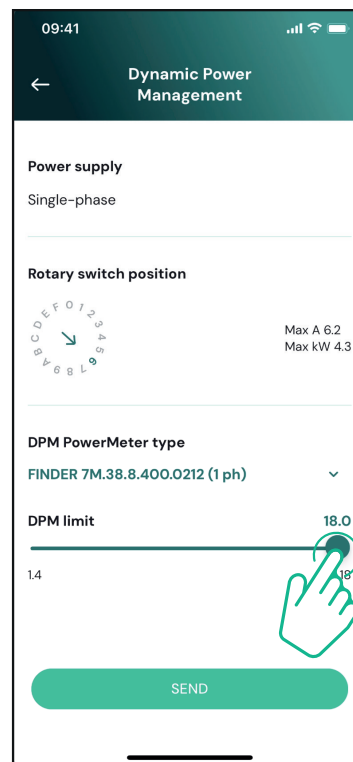

Kliknij w „Send” i potwierdź w wyskakującym okienku, aby ponownie uruchomić urządzenie **eLuxWallbox**.

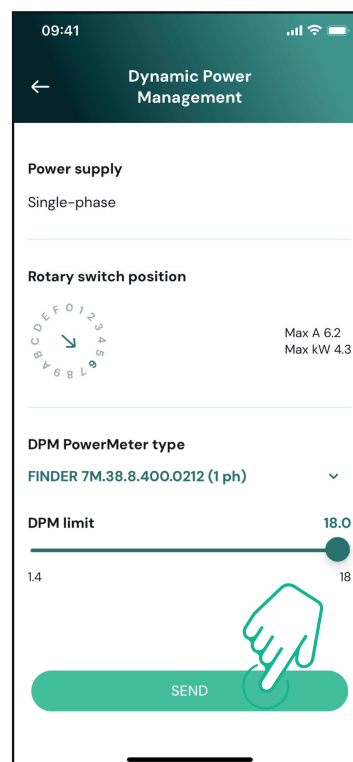

4.6. Konfiguracja MIDcounter

Aby zakończyć instalację urządzenia **MIDcounter**, wykonaj poniższe czynności:

Wybierz „**MIDcounter**” na stronie głównej

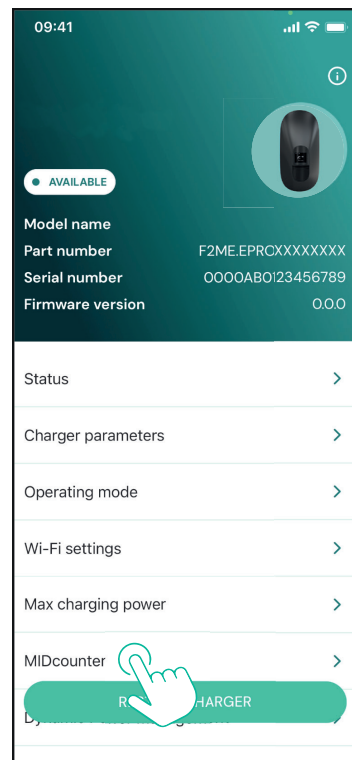

Wybierz typ urządzenia **MIDcounter** z menu rozwijanego, w zależności od zainstalowanego modelu.

Wybierz „OFF” z menu rozwijanego, aby wyłączyć konfigurację urządzenia **MIDcounter**.

Kliknij „Send”, aby potwierdzić.

Aby zmiany zostały wprowadzone, kliknij w strzałkę wstecz w lewym górnym rogu i ponownie uruchom urządzenie **eLuxWallbox** dedykowanym przyciskiem na stronie głównej.

Jeśli instalacja przewiduje zarówno urządzenie **PowerMeter** (DPM), jak i urządzenie **MIDcounter**, można kontynuować konfigurację DPM przed ponownym uruchomieniem.

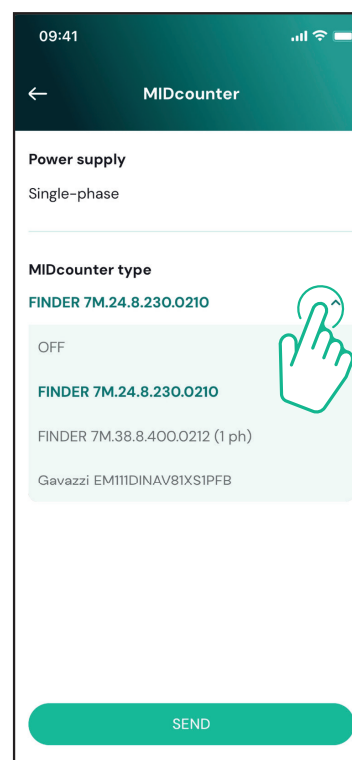

5. ROZWIĄZYWANIE PROBLEMÓW

Warunki błędów są zapisywane w rejestrach diagnostycznych i wyświetlane na panelu ładowarki:

- W modelu **eLuxWallbox Move** taśma LED miga na czerwono. Szczegółowy kod błędu można znaleźć w sekcji „**Diagnostic**” aplikacji PowerUP lub aplikacji użytkownika końcowego.
- W modelu **eLuxWallbox** na wyświetlaczu widnieje kod błędu, który jest również dostępny w sekcji „**Diagnostic**” aplikacji PowerUP.

Jeśli błąd wystąpi podczas sesji ładowania, zostanie ona przerwana, a gniazdo zostanie odblokowane, aby umożliwić odłączenie wtyczki.

Poniższa tabela zawiera listę błędów, które mogą wystąpić, oraz sposoby rozwiązywania problemów. Jeśli błąd się utrzymuje, w celu uzyskania dalszych informacji należy się skontaktować z działem obsługi klienta, podając numer seryjny widniejący na etykiecie ładowarki.

Kod błędu / problem	„Opis błędu”	Rozwiązywanie problemów
100	Brak zasilania	<p>Sprawdź, czy wyłącznik ochronny jest włączony (ON). Sprawdź, czy okablowanie CN1 jest prawidłowe. Sprawdź napięcie w CN1.</p>
101	Przegrzanie	<p>Odłącz kabel typu 2, odczekaj na obniżenie się temperatury; błąd zniknie samoistnie.</p> <p>Aby ponownie uruchomić sesję ładowania, podłącz kabel ponownie.</p> <p>Upewnij się, że miejsce instalacji jest zgodne z zakresem temperatur (- 25°C / + 50°C, bez bezpośredniego nasłonecznienia)</p>
102	Błąd komunikacji pomiędzy MCU a MPU.	<p>Ponownie uruchom ładowarkę, używając wyłącznika ochronnego, tak aby ładowarka było wyłączona przez co najmniej 60 sekund.</p> <p>Sprawdź okablowanie CN1:</p> <ul style="list-style-type: none"> - w konfiguracji jednofazowej upewnij się, że przewód uziemienia jest połączony z PE, przewód neutralny z N, a przewód fazy z T - w konfiguracji trójfazowej upewnij się, że przewód uziemienia jest połączony z PE, przewód neutralny jest połączony z N, a przewody faz L1, L2 i L3 są połączone z T, S i R.
103	Błąd sprzętowy; błąd urządzenia zabezpieczającego uziemienie (błąd GPD)	<p>Sprawdź, czy różnica napięć między PE i N nie przekracza 10 V.</p> <p>Sprawdź połączenie PE</p> <p>Jeśli wszystkie połączenia zostały sprawdzone, a błąd mimo to występuje, otwórz ładowarkę i zmień konfigurację złącza DIPswitch (SW2).</p>

104	Błąd sprzętowy, błąd monitora prądu szczytkowego AC. (zadziałanie RCM AC)	<p>Spróbuj uruchomić nową sesję ładowania, wyjmując i podłączając wszystkie złącza.</p> <p>Jeśli problem nadal występuje, sprawdź, czy nie ma żadnych problemów z kablem do ładowania lub z wejściem po stronie pojazdu.</p> <p>Jeśli kable i pojazd elektryczny nie wykazują żadnych problemów, sprawdź złącze CN27 i kabel RCM.</p>
105	Błąd sprzętowy, błąd monitora prądu szczytkowego DC. (zadziałanie RCM DC)	<p>Sprawdź, czy problem nie jest związany z kablem ani z pojazdem. Jeśli to możliwe, podejmij próbę uruchomienia kolejnej sesji ładowania, z użyciem innego pojazdu lub innego kabla.</p>
106	Błąd wewnętrznego licznika	<p>Ponownie uruchom ładowarkę, używając wyłącznika ochronnego, tak aby ładowarka było wyłączona przez co najmniej 60 sekund.</p>
107	Błąd komunikacji licznika PowerMeter (DPM)	<p>Sprawdź, czy konfiguracja komunikacji w urządzeniu DPM PowerMeter jest prawidłowa.</p> <p>Sprawdź, czy konfiguracja modelu DPM w aplikacji dla instalatora jest prawidłowa.</p> <p>Sprawdź połączenia kabla komunikacyjnego w CN12.</p> <p>Sprawdź, czy używany kabel komunikacyjny jest odpowiedni do Modbus RS485 i czy odpowiednia jest długość kabla.</p>
108	Błąd konfiguracji, pozycja przełącznika obrotowego (typ zasilania) jest niezgodna z typem DPM/MID .	<p>Sprawdź pozycję przełącznika obrotowego. Jeśli nie jest ona zgodna z instalacją jednofazową/trójfazową, zmień ją zgodnie z tabelą w instrukcji, a następnie ponownie uruchom ładowarkę.</p> <p>Jeżeli akcesoria (DPM/MID) nie są zainstalowane, upewnij się, że funkcja jest wyłączona w aplikacji dla instalatora.</p> <p>Jeżeli akcesoria (DPM/MID) są zainstalowane, sprawdź, czy w aplikacji dla instalatora wybrany jest właściwy model. Następnie ponownie uruchom ładowarkę.</p>
109	Błąd komunikacji RS485 Main/Secondary	<p>Sprawdź konfigurację układu Main/Secondary poprzez aplikację instalatora.</p> <p>Sprawdź, czy ładowarka typu Master jest dostępna.</p> <p>Sprawdź, czy połączenia kabla komunikacyjnego w CN9 i CN10 są prawidłowe.</p> <p>Sprawdź, czy używany kabel komunikacyjny jest odpowiedni do Modbus RS485.</p>

110	Błąd komunikacji licznika MIDcounter	<p>Sprawdź, czy konfiguracja komunikacji w urządzeniu MIDcounter jest prawidłowa.</p> <p>Sprawdź połączenia kabla komunikacyjnego w CN12.</p> <p>Sprawdź, czy używany kabel komunikacyjny jest odpowiedni do Modbus RS485.</p> <p>Sprawdź, czy konfiguracja modelu MID w aplikacji dla instalatora jest prawidłowa.</p>
300	Niespójność pomiędzy poleceniem stycznika ładowarki a informacją zwrotną	<p>Ponownie uruchom ładowarkę, używając wyłącznika ochronnego, tak aby ładowarka było wyłączona przez co najmniej 60 sekund.</p> <p>Jeśli błąd występuje pomimo ponownego uruchomienia urządzenia, skontaktuj się z działem obsługi klienta.</p>
301	Wykryto zwarcie na linii sterującej Control Pilot.	<p>Przy wyłączonej ładowarce sprawdź, czy nie ma uszkodzeń lub wad wewnątrz i na zewnątrz gniazda (jeżeli są, należy unikać używania ładowarki i skontaktować się z działem obsługi klienta).</p> <p>Sprawdź, czy problem nie jest związany z kablem ani z pojazdem i podejmij próbę uruchomienia kolejnej sesji ładowania (o ile to możliwe, z użyciem innego pojazdu lub innego kabla).</p>
302	Na linii sterującej Control Pilot ustawiony stan E lub F.	<p>Przy wyłączonej ładowarce sprawdź, czy nie ma uszkodzeń ani wad we wnętrzu lub na zewnątrz kabla i jego złączy (jeżeli są, należy unikać jego używania i podjąć próbę ładowania z użyciem innego kabla).</p> <p>Sprawdź, czy złącza kabla są całkowicie włożone do gniazda ładowarki oraz gniazda w pojeździe.</p> <p>Sprawdź, czy problem nie jest związany z kablem ani z pojazdem i podejmij próbę uruchomienia kolejnej sesji ładowania (o ile to możliwe, z użyciem innego pojazdu lub innego kabla).</p> <p>Podejmij próbę uruchomienia nowej sesji ładowania, po odłączeniu i ponownym włożeniu kabla, zarówno od strony ładowarki, jak i pojazdu.</p>
303	Przewód sterujący Control Pilot odłączony.	
304	Styk probierczy Proximity Pilot odłączony.	
305	Wykryto uszkodzenie styku probierczego Proximity Pilot.	
306	Wykryto awarię diody na linii sterującej Control Pilot (brak - 12 V).	

307	Przewód sterujący Control Pilot odłączony.	<p>Przy wyłączonej ładowarce sprawdź, czy nie ma uszkodzeń ani wad we wnętrzu lub na zewnątrz kabla i jego złączy (jeżeli są, należy unikać jego używania i podjąć próbę ładowania z użyciem innego kabla).</p> <p>Sprawdź, czy złącza kabla są całkowicie włożone do gniazda ładowarki oraz gniazda w pojeździe.</p> <p>Sprawdź, czy problem nie jest związany z kablem ani z pojazdem i podejmij próbę uruchomienia kolejnej sesji ładowania (o ile to możliwe, z użyciem innego pojazdu lub innego kabla).</p>
308	Niespójność pomiędzy poleceniem silnika a informacją zwrotną lub stan błędu silnika.	<p>Podejmij próbę uruchomienia nowej sesji ładowania, po odłączeniu i ponownym włożeniu kabla, zarówno od strony ładowarki, jak i pojazdu.</p> <p>Sprawdź, czy złącza kabla są całkowicie włożone do gniazda ładowarki oraz gniazda w pojeździe.</p>
309	Błąd kontroli silnika podczas fazy inicjalizacji EVSE.	Ponownie uruchom ładowarkę, używając wyłącznika ochronnego, tak aby ładowarka było wyłączona przez co najmniej 60 sekund.
310	Wykryto błąd przed ładowaniem (nie wykryto PP, błąd silnika lub nie wykryto CP).	<p>Przy wyłączonej ładowarce sprawdź, czy nie ma uszkodzeń ani wad we wnętrzu lub na zewnątrz kabla i jego złączy (jeżeli są, należy unikać jego używania i podjąć próbę ładowania z użyciem innego kabla).</p> <p>Sprawdź, czy złącza kabla są całkowicie włożone do gniazda ładowarki oraz gniazda w pojeździe.</p>
311	Wykryto błąd po ładowaniu (błąd silnika lub nie odłączono CP).	Sprawdź, czy problem nie jest związany z kablem ani z pojazdem i podejmij próbę uruchomienia kolejnej sesji ładowania (o ile to możliwe, z użyciem innego pojazdu lub innego kabla).
312	Zatrzymanie awaryjne otrzymane z MPU.	Ponownie uruchom ładowarkę, używając wyłącznika ochronnego, tak aby ładowarka było wyłączona przez co najmniej 60 sekund.
313	Wykryto prąd podczas ładowania, przy 100% cyklu pracy na linii sterującej Control Pilot.	Sprawdź, czy problem nie jest związany z kablem ani z pojazdem i podejmij próbę uruchomienia kolejnej sesji ładowania z użyciem innego kabla i/lub innej ładowarki.
315	Prąd przekroczony na fazie L1	Odłącz kabel; jeśli to możliwe, obniż moc ładowania po stronie pojazdu i podejmij próbę uruchomienia nowej sesji ładowania.
316	Prąd przekroczony na fazie L2	
317	Prąd przekroczony na fazie L3	

318	Napięcie poniżej wartości progowej na fazie L1	<p>Sprawdź, czy pozycja przełącznika obrotowego jest zgodna z instalacją 1-fazową/3-fazową.</p> <p>Sprawdź, czy napięcie na CN1-R jest wyższe niż 196 V. Jeżeli napięcie jest niższe niż 196 V, sprawdź instalację elektryczną lub skontaktuj się z dostawcą energii elektrycznej.</p> <p>Jeśli błąd występuje podczas ładowania pojazdu, spróbuj zmniejszyć zadaną moc ładowania i sprawdź, czy instalacja elektryczna jest prawidłowo zwymiarowana pod kątem poboru mocy przez pojazd.</p>
319	Napięcie poniżej wartości progowej na fazie L2	<p>Przełącznik obrotowy jest w pozycji dla trzech faz. Sprawdź, czy zamierzona instalacja to instalacja trójfazowa. Jeśli nie, wybierz prawidłową pozycję przełącznika obrotowego zgodnie z Instrukcją instalacji.</p> <p>Sprawdź, czy napięcie na CN1-S i R jest wyższe niż 196 V. Jeżeli napięcie jest niższe niż 196 V, sprawdź instalację elektryczną lub skontaktuj się z dostawcą energii elektrycznej.</p>
320	Napięcie poniżej wartości progowej na fazie L3	<p>Jeśli błąd występuje podczas ładowania pojazdu, spróbuj zmniejszyć zadaną moc ładowania i sprawdź, czy instalacja elektryczna jest prawidłowo zwymiarowana pod kątem poboru mocy przez pojazd.</p>
321	Zabroniona zmiana stanu (IEC 61851-1)	<p>Pojazd elektryczny nie spełnia norm IEC 61851-1 dotyczących uruchamiania sesji ładowania.</p> <p>Podejmij próbę uruchomienia nowej sesji ładowania, po odłączeniu i ponownym włożeniu kabla, zarówno od strony ładowarki, jak i pojazdu.</p> <p>Jeśli błąd nadal ma miejsce, skontaktuj się z producentem pojazdu.</p>

Wyświetlacz/dioda zablokowany(-a) w trybie powitalnym (dioda miga na czerwono, zielono i niebiesko)
Moduł LED lub wyświetlacz nie zaświeca się podczas uruchamiania

Ponownie uruchom ładowarkę, używając wyłącznika ochronnego, tak aby ładowarka było wyłączona przez co najmniej 60 sekund.

	<p>Ładowarka nie uruchamia się</p>	<p>Pozwól urządzeniu ponownie się uruchomić, co może potrwać maks. 30 sekund.</p> <p>Sprawdź, czy wyłącznik ochronny jest włączony (ON).</p> <p>Sprawdź, czy okablowanie CN1 jest prawidłowe.</p> <p>Sprawdź napięcie w CN1.</p> <p>Ponownie uruchom ładowarkę, używając wyłącznika ochronnego, tak aby ładowarka było wyłączona przez co najmniej 60 sekund.</p>
	<p>Kabel zablokowany w gnieździe ładowarki</p>	<p>Wyłącz ładowarkę za pomocą wyłącznika ochronnego, a następnie wyciągnij kabel.</p>
	<p>Na wyświetlaczu widoczny jest komunikat Suspended Charging i świeci światłem stałym zielona dioda. Sesja ładowania została zawieszona przez DPM lub EV. Można wznowić sesję.</p>	<p>Sprawdź, czy maksymalna moc w części dotyczącej limitu mocy DPM w aplikacji PowerUp jest zgodna z umowną wartością mocy w kW, wskazaną w umowie użytkownika na dostarczanie energii elektrycznej. Jeżeli wartość jest prawidłowa, poczekaj na wznowienie sesji ładowania lub wyłącz niektóre obciążenia w domu.</p> <p>W przypadku instalacji trójfazowej sprawdź, czy obciążenia elektryczne dla faz w domowej instalacji są dobrze zrównoważone.</p>
	<p>Po zeskanowaniu kodu QR parowanie aplikacji nie dochodzi do skutku.</p>	<p>Sprawdź, czy kod QR na etykiecie jest w całości widoczny.</p> <p>Zaktualizuj aplikację do najnowszej wersji.</p> <p>Zamknij i uruchom ponownie aplikację, a następnie spróbuj ponownie.</p> <p>Ponownie uruchom ładowarkę, używając wyłącznika ochronnego, tak aby ładowarka było wyłączona przez co najmniej 60 sekund.</p>

6. CZYSZCZENIE

Czyszczenie urządzenia z zewnątrz jest zalecane zawsze, gdy zachodzi taka potrzeba i powinno być wykonywane za pomocą miękkiej, wilgotnej szmatki z łagodnym detergentem. Na zakończenie należy zetrzeć wszelkie ślady wilgoci lub płynu miękką, suchą szmatką.



PRZESTROGA: należy unikać silnych strumieni powietrza lub wody, a także używania mydła lub detergentów o działaniu zbyt agresywnym i korozyjnym dla materiałów, z których wykonano ładowarkę.

7. UTYLIZACJA OPAKOWAŃ



Opakowania należy utylizować w sposób przyjazny dla środowiska. Materiały użyte do pakowania tego produktu nadają się do recyklingu i należy je utylizować zgodnie z przepisami obowiązującymi w kraju użytkowania. Dalsze wskazówki dotyczące utylizacji można znaleźć na opakowaniu, w zależności od rodzaju materiału.



UWAGA: dalsze informacje dotyczące aktualnych miejsc utylizacji można uzyskać od władz lokalnych.

8. POMOC

Jeśli masz jakiegokolwiek pytania dotyczące instalacji **eLuxWallbox**. W celu uzyskania innych informacji lub w razie potrzeby uzyskania wsparcia skontaktuj się z firmą Free2move eSolutions S.p.A. za pośrednictwem odpowiedniej sekcji na stronie internetowej: www.esolutions.free2move.com.

9. ZRZECZENIE SIĘ ODPOWIEDZIALNOŚCI

Free2move eSolutions S.p.A. nie ponosi odpowiedzialności za jakiegokolwiek szkody bezpośrednio lub pośrednio wyrządzone ludziom, rzeczom lub zwierzętom w wyniku nieprzestrzegania wszystkich postanowień zawartych w niniejszej instrukcji oraz ostrzeżeń dotyczących instalacji i konserwacji urządzenia **eLuxWallbox**.

Free2move eSolutions S.p.A. zastrzega sobie wszelkie prawa do tego dokumentu, treści oraz ilustracji zawartych w dokumencie. Jakiegokolwiek powielanie w całości lub części, ujawnianie osobom trzecim lub wykorzystywanie ich zawartości bez uprzedniej pisemnej zgody Free2move eSolutions S.p.A. jest zabronione.

Wszelkie informacje zawarte w niniejszej instrukcji mogą ulec zmianie bez wcześniejszego powiadomienia i nie stanowią żadnego zobowiązania ze strony producenta. Ilustracje w tej instrukcji służą wyłącznie do celów poglądowych i mogą różnić się od dostarczonego produktu.

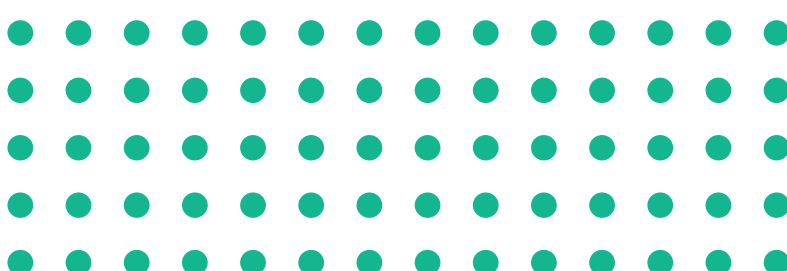

Siedziba
Free2move eSolutions S.p.A.
Piazzale Lodi, 3
20137 Milan - Italy
www.esolutions.free2move.com

EN

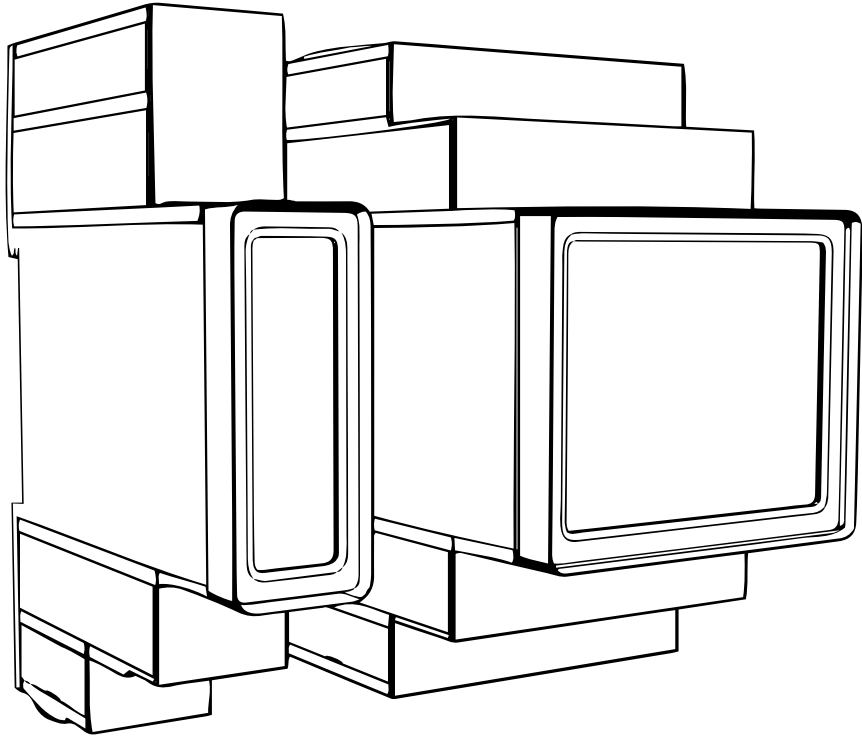
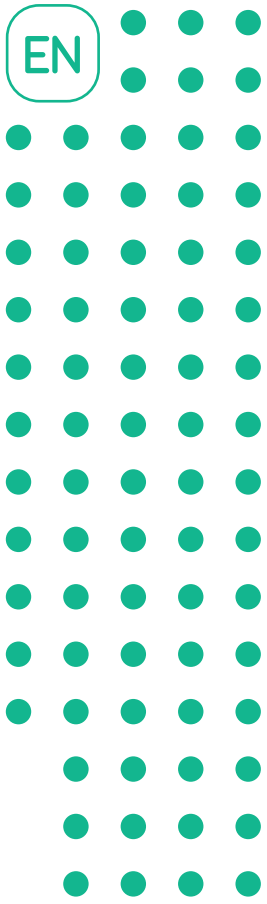

LuxWallbox

Accessories Manual



For safe and proper use,
follow these instructions.
Keep them for future reference

Table of content

1. INTRODUCTION	4
1.1. Purpose of the Manual	4
1.2. Identification of the Manufacturer.....	4
1.3. Structure of the Accessories Manual	4
1.4. Safety	5
1.5. Personal Protective Equipment (PPE).....	6
1.6. Warranty and delivery conditions	6
1.7. List of documents.....	7
1.8. Warnings	7
2. GENERAL INFORMATION	8
2.1. Fields of use	9
3. ACCESSORIES INSTALLATION	10
3.1. Installing PowerMeter (DPM).....	10
3.2. Installing MIDcounter	15
3.3. Communication cable installation	17
3.4. MIDcounter and PowerMeter (DPM) combined installation .	19
4. PowerMeter (DPM) and MIDcounter configuration.	22
4.1. Finder models.....	22
4.2. Gavazzi models.....	24
4.3. Device configuration summary	25
4.4. PowerMeter (DPM) and MIDcounter configuration on APP ..	26
4.5. PowerMeter (DPM) configuration	28
4.6. MIDcounter configuration.....	30
5. TROUBLESHOOTING.....	31
6. CLEANING.....	36
7. PACKAGING DISPOSAL	36
8. ASSISTANCE.....	37
9. DISCLAIMER.....	37



1. INTRODUCTION

1.1. Purpose of the Manual

This installation manual is a guide to help operators to work safely and carry out the installation operations needed to keep the charger in good working order.

The purpose of this document is to support qualified technicians who have received appropriate training, and demonstrated suitable skills and knowledge in the construction, installation, operation and maintenance of electrical equipment.

If the charger is used in a manner not specified in this manual, the protection provided by the charger may be impaired. This document contains the information required for the installation of the charger.

This document has been carefully checked by the Manufacturer Free2move eSolutions S.p.A. but oversights cannot be completely ruled out. If any errors are noted, please inform Free2move eSolutions S.p.A. Except for explicit contractual obligations, under no circumstances may Free2move eSolutions S.p.A. be held liable for any loss or damage resulting from the use of this manual, or from installation of the equipment. This document was originally written in English. In the event of any inconsistencies or doubts, please ask Free2move eSolutions S.p.A. for the original document.

1.2. Identification of the Manufacturer

The manufacturer of the charger is:

Free2move eSolutions S.p.A.

Piazzale Lodi, 3

20137 Milan – Italy

www.esolutions.free2move.com

1.3. Structure of the Accessories Manual





This manual is divided into chapters based on different topics and containing all the information that is needed to install the charger safely.

Each chapter is sub-divided into paragraphs which examine the fundamental points, and each paragraph may have its own title, along with sub-titles and a description.

1.4. Safety

This manual contains important safety instructions that must be followed during installation of the charger.

In order to fulfil this objective, this manual contains a number of precautionary texts, containing special instructions. These instructions are highlighted by a specific text box and are accompanied by a symbol, and are provided in order to ensure the safety of the personnel required to perform the operations described, and to avoid any damage to the charger and/or property:

	<p>This symbol means: DANGER</p> <p>This symbol is intended to highlight a dangerous situation for yourself and others. Read it carefully. Failure to comply with the instruction will result in an imminent hazardous situation which, if not avoided, will result in instant death, or serious or permanent injury.</p>
	<p>This symbol means: WARNING</p> <p>This symbol is intended to highlight safety information. Failure to comply with the instruction will result in a potentially hazardous situation which, if not avoided, could result in death or serious injury.</p>
	<p>This symbol means: CAUTION</p> <p>This symbol is intended to highlight safety information. Read it carefully. Failure to follow these instructions can result in death, serious injury or damage to equipment.</p>
	<p>This symbol means: NOTE</p> <p>Provides additional information to supplement instructions provided.</p>
	<p>This symbol means: NOTICE</p> <p>Provides instructions concerning the use of conduct necessary to handle the operations not associated with possible physical injuries.</p>

Installation must be carried out by qualified personnel. A dedicated, state-of-the-art electricity supply system must be designed and installed, and the system must be certified in compliance with local regulations and the energy supply contract.

Operators are required to read and fully understand this manual, and to comply strictly with the instructions it contains.

Free2move eSolutions S.p.A. cannot be held liable for damage caused to persons and/ or property, or to the equipment, if the conditions described in this document have not been complied with.





WARNING: Installation must be carried out in accordance with the regulations in force in the country of installation, and in compliance with all safety regulations for carrying out electrical work.

1.5. Personal Protective Equipment (PPE)

Personal Protective Equipment (PPE) means any equipment intended to be worn by the workers in order to protect them against one or more hazards likely to threaten their health or safety at the workplace, as well as any device or accessory intended for this purpose.

Since all the PPE indicated in this manual is intended to protect the personnel against health and safety hazards, the Manufacturer of the charger which is the subject of this manual recommends strict compliance with the indications contained in the various sections of this manual.

The list of PPE to be used in order to protect the operators against the residual risks present during the installation and maintenance interventions described in this document is provided below.

Symbol	Meaning
	Wear protective gloves
	Wear anti-static footwear



WARNING: It is responsibility of the operator to read and understand local regulations and evaluate the environmental conditions of the installation site in order to comply the need to wear additional PPE.

1.6. Warranty and delivery conditions

The warranty details are described in the Terms and Conditions of Sale included with the purchase order for this product and/or in the packaging of the product.

Free2move eSolutions S.p.A. assumes no responsibility for failure to comply with the instructions for proper installation, and cannot be held responsible for systems upstream or downstream of the equipment supplied.

Free2move eSolutions S.p.A. cannot be held responsible for defects or malfunctions deriving from: improper use of the charger; deterioration due to transport or particular environmental conditions or installation by unqualified persons.

Free2move eSolutions S.p.A. is not responsible for any disposal of the equipment, or parts thereof, that does not comply with the regulations and laws in force in the country of installation.



NOTICE: Any modification, manipulation or alteration of the hardware or software not expressly agreed with the manufacturer will immediately void the warranty.

1.7. List of documents

In addition to this manual, product documentation can be viewed and downloaded by visiting: www.esolutions.free2move.com.

1.8. Warnings



DANGER: Risk of electric shock and fire. Installation must be carried out in accordance with the regulations in force in the country of installation, and in compliance with all safety regulations for carrying out electrical work.

- Before installing or using the device, make sure that none of the components have been damaged. Damaged components can lead to electrocution, short circuits, and fire due to overheating. A device with damage or defects must not be used.
- Install **eLuxWallbox** away from petrol cans or combustible substances in general.
- Before installing **eLuxWallbox compatible accessories**, ensure the main power source has been disconnected.
- The **eLuxWallbox compatible accessories** must only be used for the specific applications they are designed for.
- Installation not carried out correctly may pose risks to the user.
- The charger must be connected to a mains network in compliance with local and international standards, and all the technical requirements indicated in this manual.
- Children or other persons not able to gauge risks related to the installation of the charger could suffer serious injury or put their lives at risk.
- Pets or other animals must be kept away from the device and packaging material
- Children must not play with the device, accessories or packaging provided with the product.
- The only part that can be removed from **eLuxWallbox**, is the removable cover. Access under the cover is only permitted by qualified personnel during installation, dismantling or maintenance.
- **eLuxWallbox** can only be used with an energy source.
- Necessary precautions to ensure safe operation with Active Implantable Medical Devices must be taken. To determine whether the charging process could adversely affect the medical device, please contact its manufacturer.

2. GENERAL INFORMATION

eLuxWallbox is an Alternate Current charging solution for powering electric vehicles and hybrid plug-ins, and is ideal for semi-public and residential use. The charger is available in three-phase or single-phase configurations and is equipped with a Type 2 socket.

The charger charges electric vehicles up to 22 kW in three-phase, or up to 7.4 kW in single-phase. The charger includes connectivity options such as remote monitoring via the eSolutions control platform (CPMS). Its final configuration must be completed using the **PowerUp** application. For the end user, the **eLuxWallbox** can be managed via the dedicated user's eSolutions Charging App. Both applications are available on Google Play™ and Apple Store®.

This charger is equipped with a SIM card for connection to the 4G mobile network.

The SIM card is automatically activated the first time the charger is turned on.

This document describes how to install the external accessories compatible with the **eLuxWallbox**.

The external accessories described in this manual are:

- **PowerMeter (DPM)**: an energy meter that enables the Dynamic Power Management (**DPM**) which is a smart function that allows an electric vehicle to be recharged using only the power available at home, modulating the charging power and avoiding unpleasant blackouts.
- **MIDcounter**: a certified energy meter that allows to monitor the consumption of the **eLuxWallbox** during each charging session.

This manual contains a description of the characteristics of the different accessories, information on models, installation process and final configuration of the devices.

The **eLuxWallbox** is configured to be used with the following electrical accessories: **PowerMeter (DPM)** or **MIDcounter**:

- Gavazzi, 1-phase, Direct, 32 A
- Finder, 1-phase, Direct, 40 A
- Gavazzi, 3-phase, Direct, 65 A
- Finder, 3-phase, Direct, 80 A

PowerMeter (DPM):

- Gavazzi, 1-phase, Indirect with 1x CT 100 A
- Gavazzi, 1-phase, Indirect with 1x CTV 60 A
- Gavazzi, 3-phase, Indirect with 3x CT 150 A



WARNING: Do not try to install the Electrical Accessories if you are not qualified as a professional electrician. To do so could cause serious danger and harm to you and to the people, property or animals around you.

To complete the installation, it is necessary to configure the **eLuxWallbox** through the dedicated apps:

	Installer's app: PowerUp
Product versions (EU):	EPRO23S224GWBAX
Product versions (UK):	EPRO23S224GWBAS



WARNING: Only Electrical Accessories suggested by Free2move eSolutions S.p.A. are compatible. Installation must be performed by qualified personnel in accordance with local regulations.

2.1. Fields of use

Free2move eSolutions S.p.A. declines all liability for any damage whatsoever due to incorrect or careless actions.

The charger may not be used for any purpose other than the one it is intended to fulfill.

The equipment must not be used by children or people with limited mental or physical abilities, or even by adults or expert professionals if the charger undergoes operations that do not comply with this manual and accompanying documentation.

The charger is a charging device for electric vehicles; the following classification (according to IEC 61851-1) identifies its characteristics:

- Power supply: permanently connected to the AC power supply grid
- Output: Alternate Current
- Environmental conditions: indoor / outdoor use
- Fixed installation
- Protection against electric shock: Class I
- EMC Environment classification: Class B
- Charging type: Mode 3 according to the IEC 61851-1 standard
- Optional function for ventilation not supported

3. ACCESSORIES INSTALLATION

To install the electrical accessories, it is necessary to use Modbus communication cables with the following characteristics:

- Modbus RS485 twisted STP 2x2 AWG24 or S/FTP cat.7 suitable for installation with a 400V power line
- Conductor size: 0.5 mm²
- Stripping length: 10 mm
- Recommended maximum length: 150 m

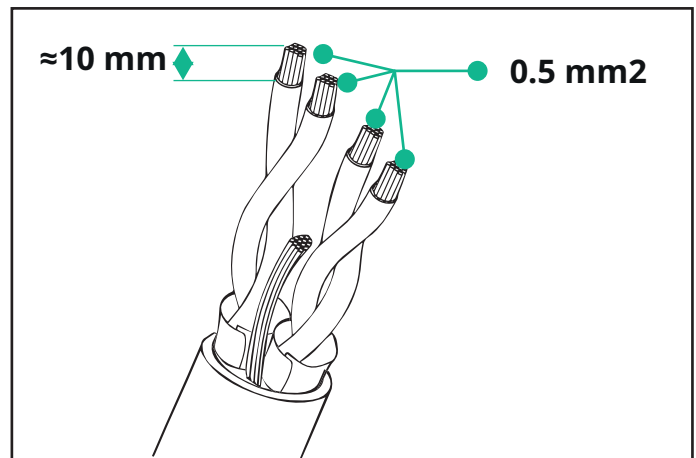

3.1. Installing PowerMeter (DPM)

PowerMeter (DPM) is an energy meter that enables the Dynamic Power Management (**DPM**) which is a smart function that allows an electric vehicle to be recharged using only the power available at home, modulating the charging power and avoiding unpleasant blackouts. Whenever other appliances are being used during the charging session, the system can modulate the charging power towards the car, even temporarily suspending the charging session. As soon as the other domestic appliances are switched off, the session will resume.

The **DPM** smart logic works both in three-phase and in single-phase installations.



WARNING: When installing in three-phase systems, make sure that the electrical loads (including the wallbox) are well balanced between the phases of the electrical system.



WARNING: Before carrying out any installation or maintenance work on the device, it must be ensured that the power supply is switched off.

For Direct models of the PowerMeter (DPM):

Place the **PowerMeter (DPM)** after the main utility meter. The **PowerMeter (DPM)** must measure all the electrical loads, including the **eLuxWallbox**.

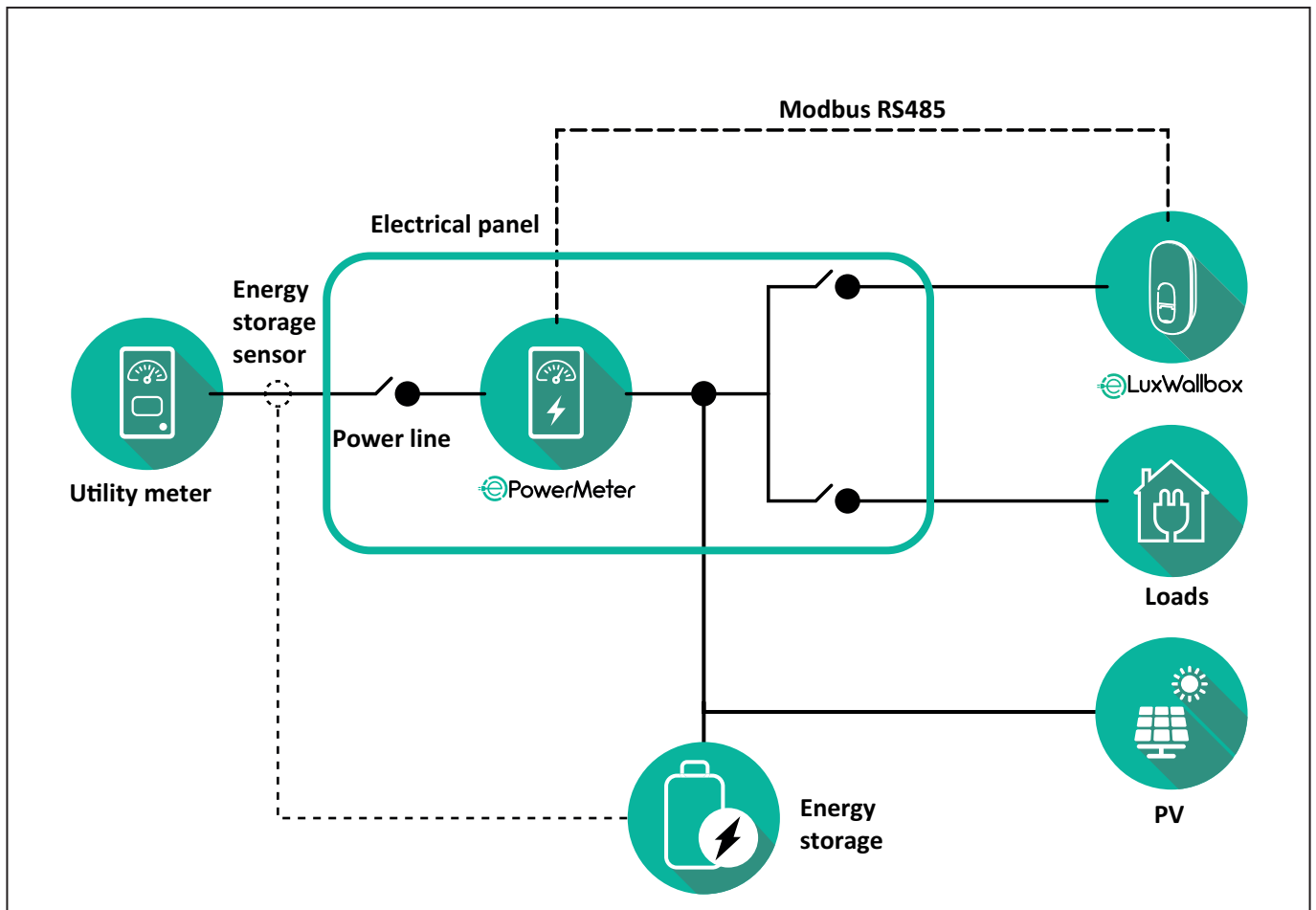

For Direct models of the PowerMeter:



WARNING: During the installation always refer to the manufacturer installation manual provided with the meter.



NOTE: For the single-phase or three-phase electrical connection of the Direct **PowerMeter**, please refer to the diagrams below.

Finder model 1ph and 3ph

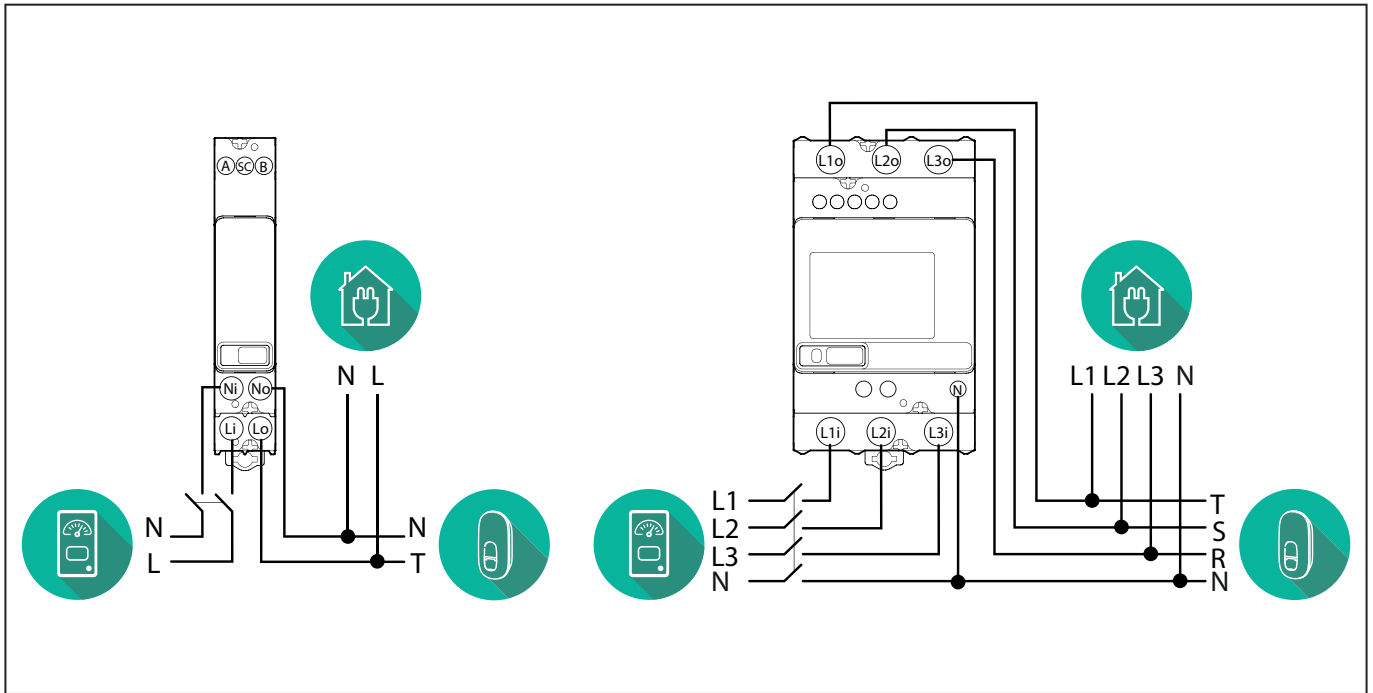

Gavazzi model 1ph and 3ph

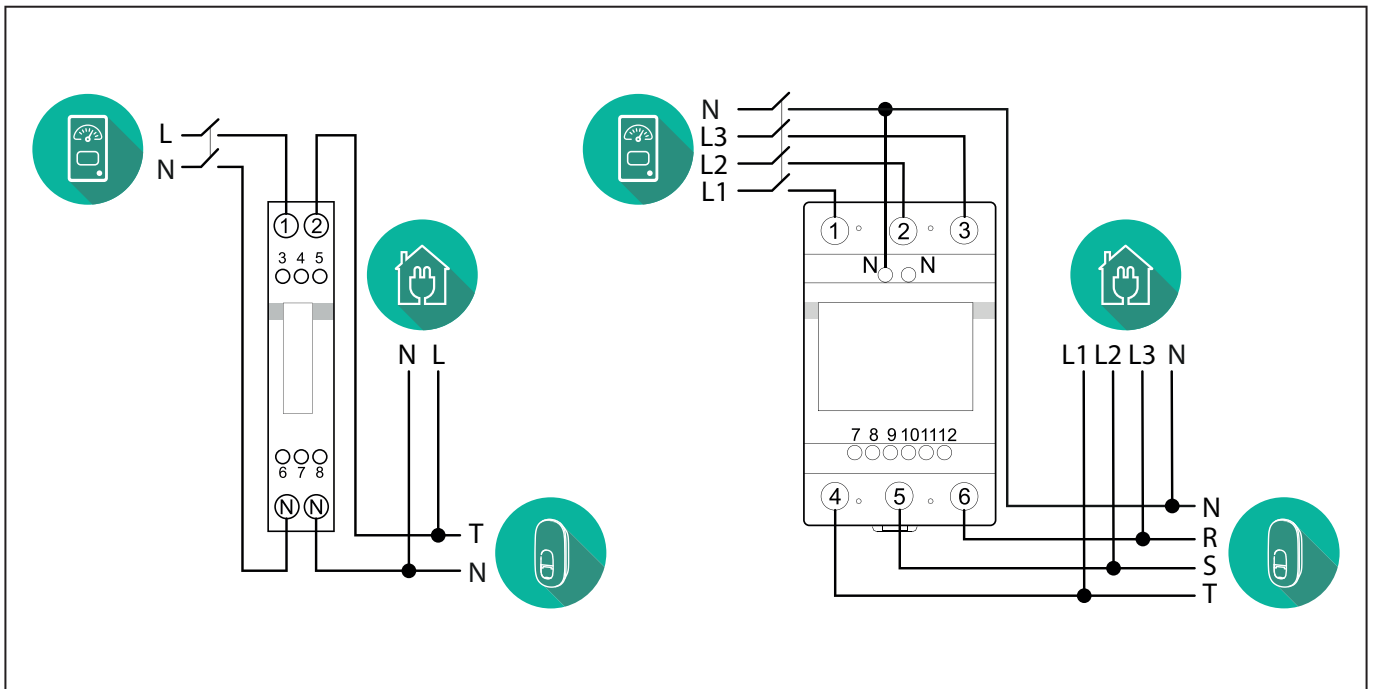

NOTICE:



- 1) If PV is present, the **PowerMeter** should be placed between the Utility Meter and the PV connection point.
- 2) If there is a home Energy storage, the **PowerMeter** should be placed between the Energy storage connection point and the Energy storage measurement sensor.

For Indirect models of the PowerMeter:

Place the CT (current transformer) of the **PowerMeter** after the main utility meter and before the main switch of the house/building. The current transformer must measure all the domestic loads, including the **eLuxWallbox**.

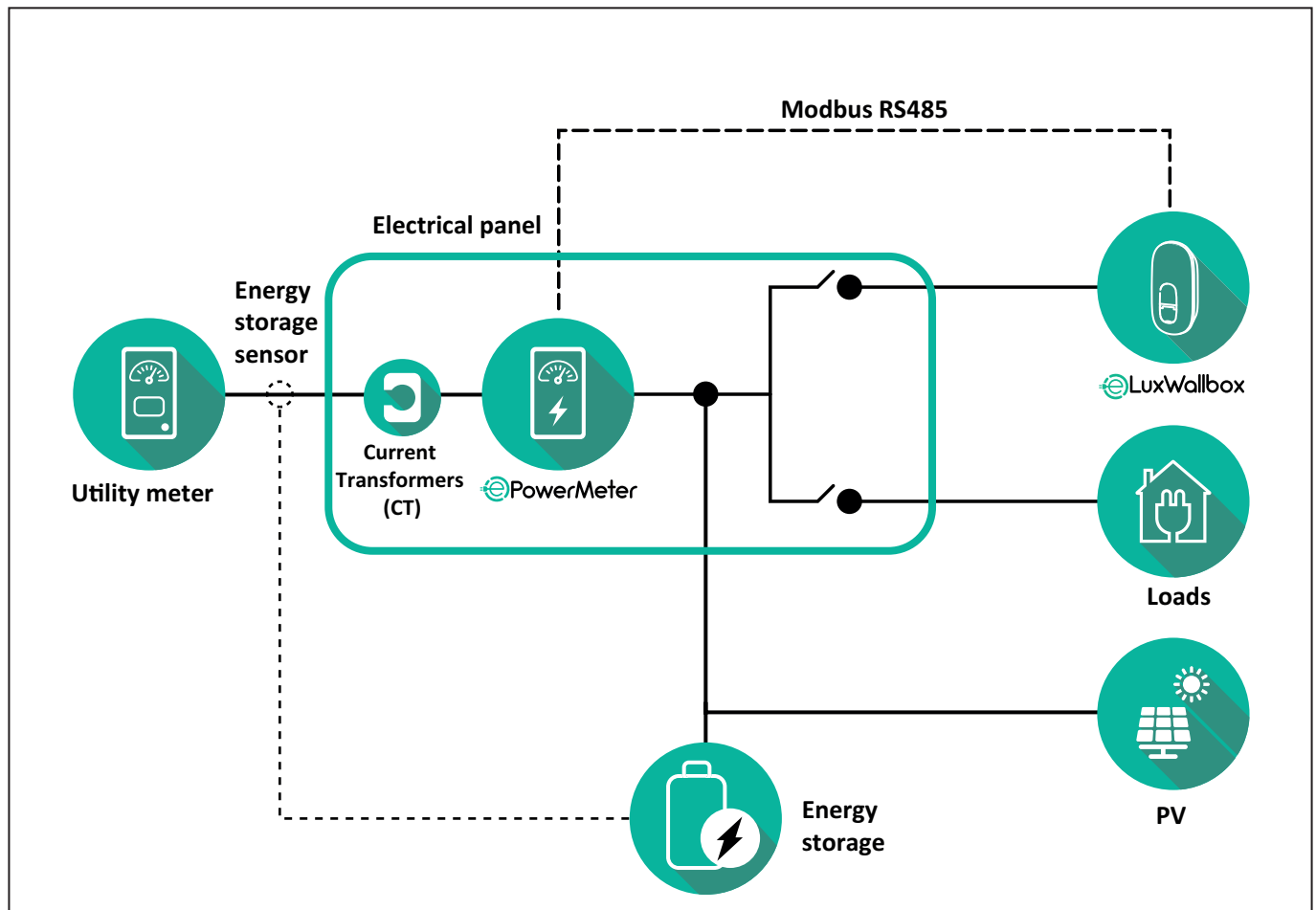

NOTICE:



1) If PV is present, the **PowerMeter** Current Transformers (CT) should be placed between the PV connection point and the Utility Meter.

2) If there is a home Energy storage, the **PowerMeter** Current Transformers (CT) should be placed between the Energy storage connection point and the Energy storage measurement sensor.

Connect the Current Transformers (CT) as indicated in the meter installation manual. Point the arrow on the CT in the direction of the loads.

For the three-phase or single-phase electrical connection of the indirect **PowerMeter**, refer to the diagrams below.

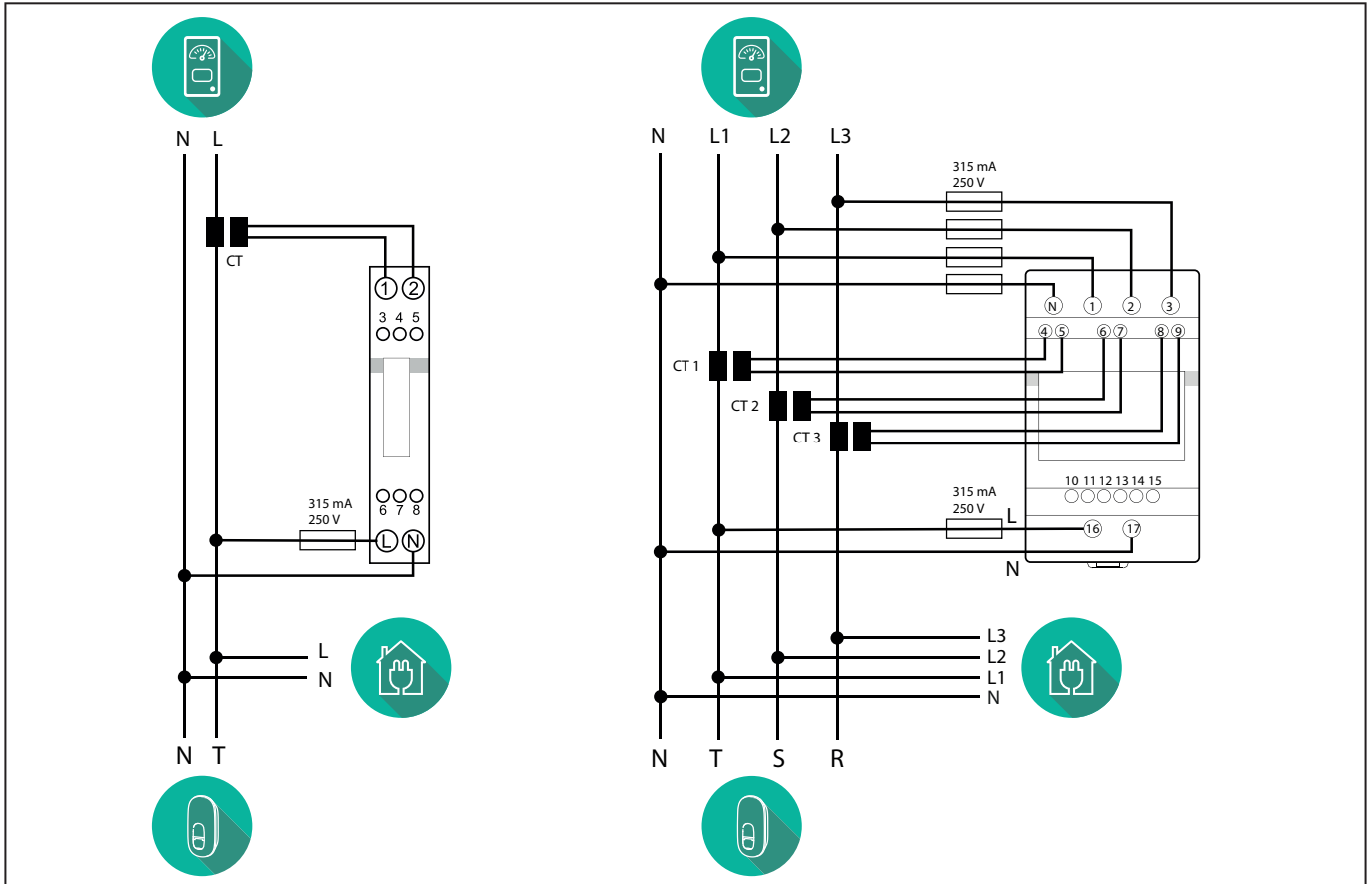

3.2. Installing MIDcounter

The **MIDcounter** is a certified energy meter that allows the consumption of the charger to be safely and reliably monitored during each charging session.

All the relevant data of the charging sessions is automatically recorded by a certified **MID** meter and transferred from the charger to the Charge Point Management System (CPMS).



WARNING: The power to the charger must remain off during this step.

Place the **MIDcounter** on the same power line as the charger, after the electrical protection devices.

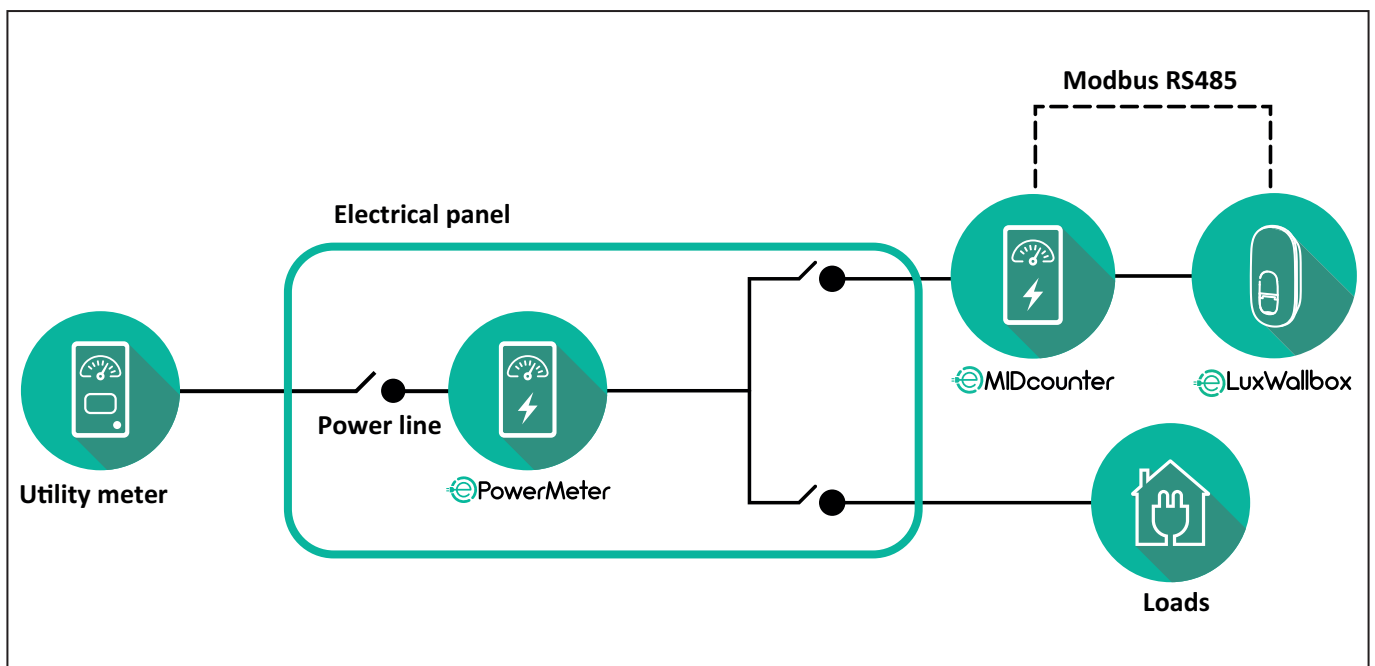

See the diagrams below for single phase and three phase electrical connection of **MIDcounter** (Finder and Gavazzi).

**Finder 1-phase, Direct, 40 A
(7M2482300210)**

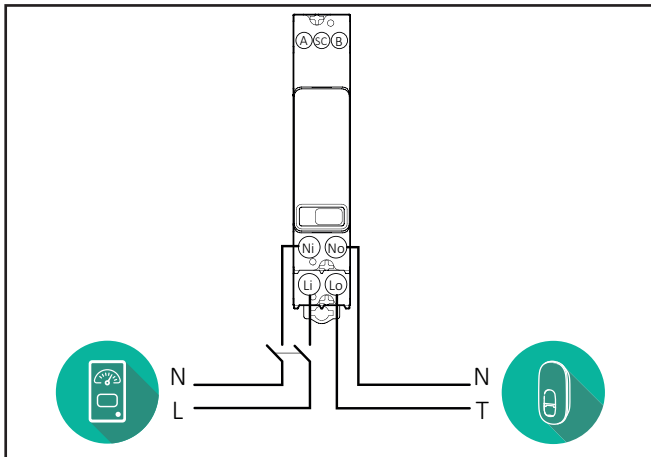

**Gavazzi, 3-phase, Direct, 65 A
(EM340DINAV23XS1PFB)**

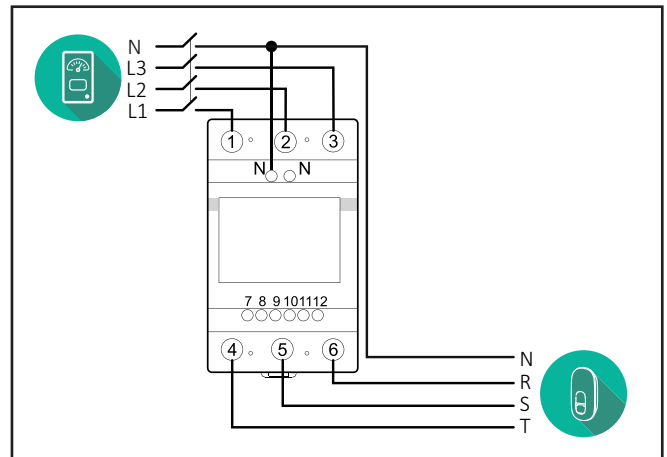

**Finder 3-phase, Direct, 80 A
(7M3884000212)**

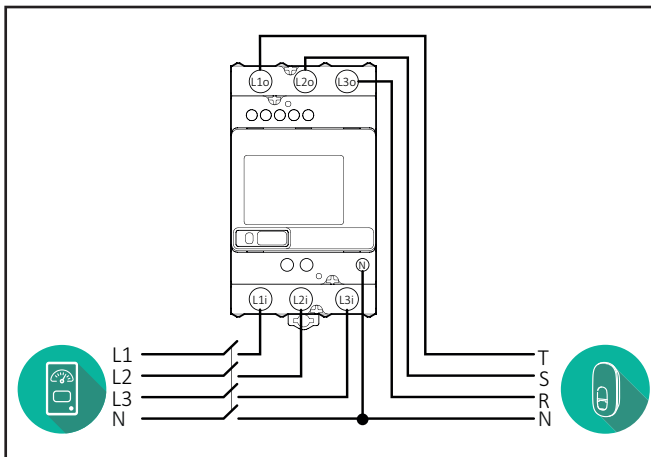

**Gavazzi, 1 phase, Direct, 100 A
(EM112DINAV01XS1PFB)**

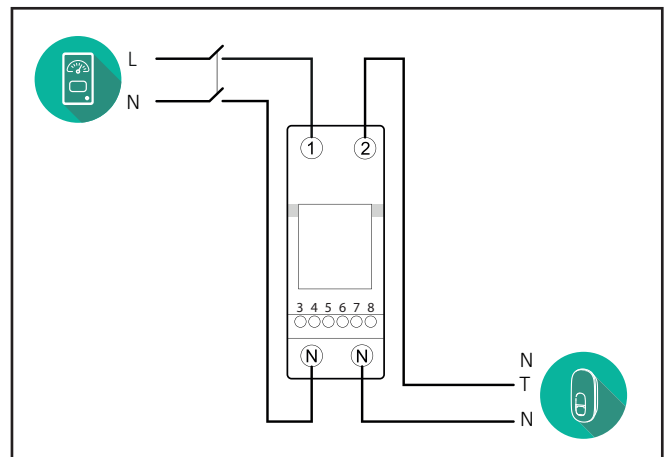

**Gavazzi, 1-phase, Direct, 32 A
(EM111DINAV81XS1PFB)**

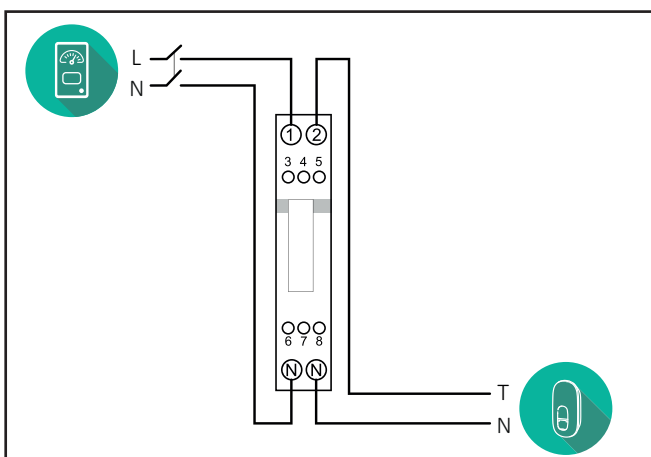

3.3. Communication cable installation

Install a communication cable between the **PowerMeter (DPM)** and the **eLuxWallbox**.

- On the **eLuxWallbox**, remove the protective cap of the communication cables entry point and insert the \varnothing 25 mm corrugated sheath.
- Tighten the box-cable sheath junction.
- Insert the communication cable, pulling it to a suitable length so that it reaches the communication port CN12, leaving some slack.
- Connect the Modbus RS485 communication cable to the GND, - and + pins of the CN12 connector.



NOTE: It is possible to replace the box-cable sheath junctions with \varnothing 25mm cable gland (not provided by the manufacturer).

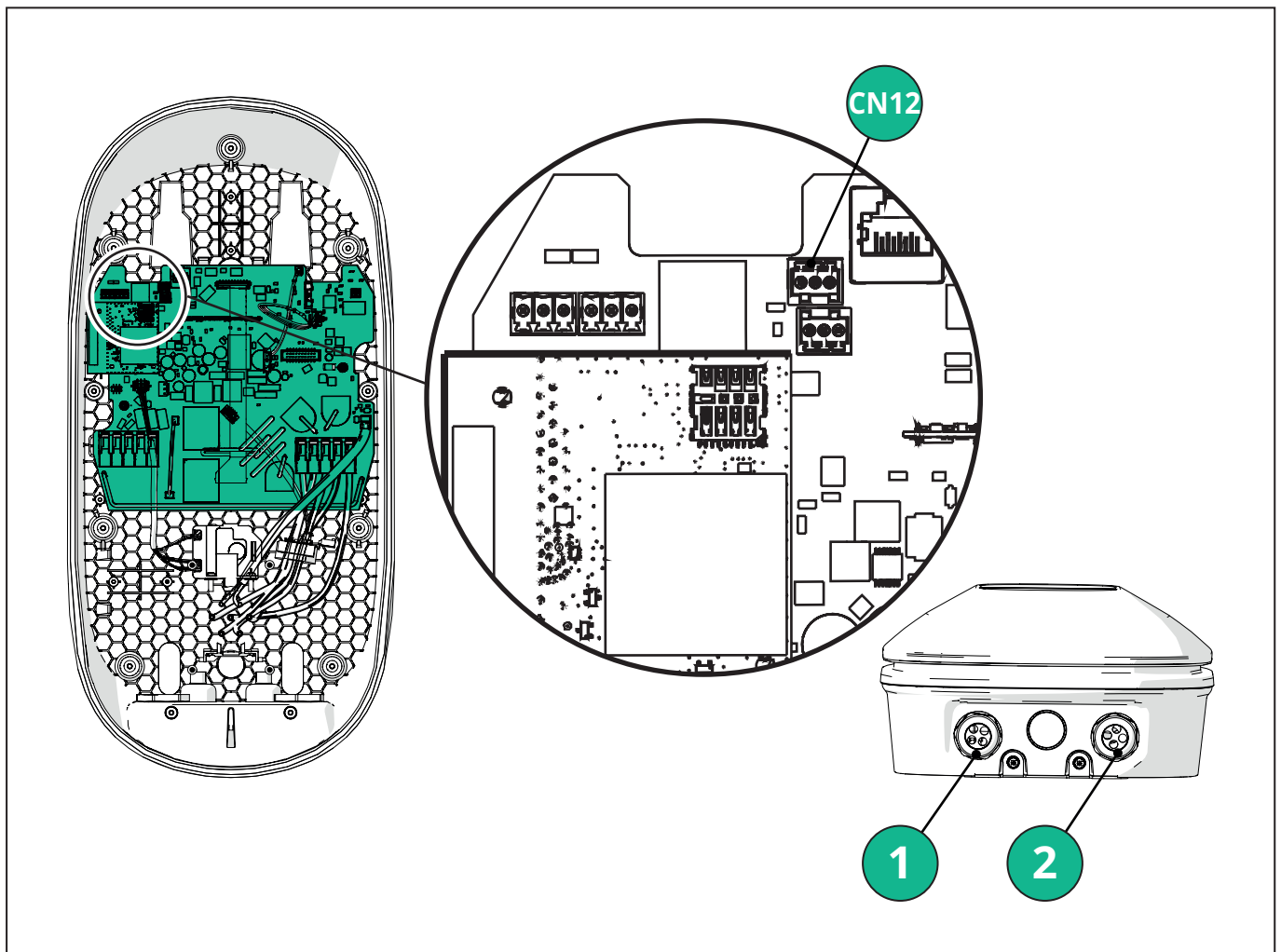

1 - Power supply cables

2 - Communication cables

CN12 - RS485 Modbus for external meter communication (**DPM** and **MID**)

Connect the communication cables in the following order from the **PowerMeter (DPM)** to **eLuxWallbox**.



WARNING: If the installation includes both accessories, follow the instructions for “MIDcounter and PowerMeter (DPM) combined installation”.

CN12	Finder 1ph 7M.24.8.230.0210
GND	SC
-	B
+	A

CN12	Gavazzi 3ph EM340DINAV23XS1PFB
GND	10
-	9
+	8

Junction 9/7

CN12	Finder 3ph 7M.38.8.400.0212
GND	SC
-	B
+	A

CN12	Gavazzi Ind 1ph EM111DINAV51XS1X / EM111DINMV51XS1X
GND	7
-	8
+	6

Junction 8/5

CN12	Gavazzi 1ph EM111DINAV81XS1PFB
GND	7
-	8
+	6

Junction 8/5

CN12	Gavazzi Ind 3ph EM330DINAV53HS1X
GND	13
-	12
+	11

Junction 12/10

3.4. MIDcounter and PowerMeter (DPM) combined installation

If installing both electrical accessories, the positioning of **MIDcounter** together with the **PowerMeter (DPM)** is indicated in the diagram below:

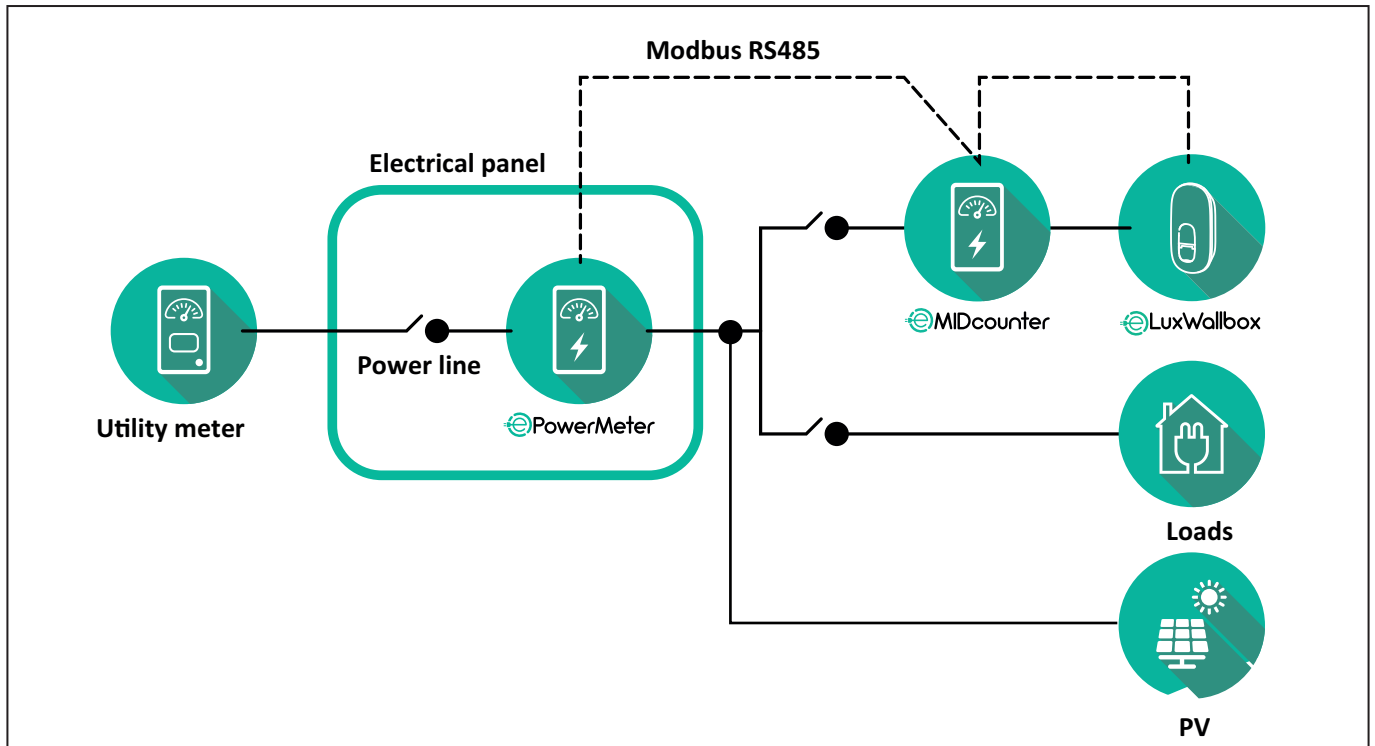

Connect the Modbus communication cables. The **PowerMeter (DPM)**, **MIDcounter** and the **eLuxWallbox** must be connected on the same communication bus in a Daisy chain format.

On the **eLuxWallbox**:

- Remove the protective cap of the communication cable entry point and insert the Ø 25 mm corrugated sheath.
- Tighten the box-cable sheath junction.
- Insert the communication cable, pulling it to a suitable length so that it reaches the communication port CN12, leaving some slack.
- Connect the Modbus RS485 communication cable to the GND, - and + pins of the CN12 connector.

Use the table below to connect the communication cables from the accessories to the **eLuxWallbox**.

Single-Phase.

PowerMeter (DPM)	MIDcounter	eLuxWallbox
EM111DINAV51XS1X - EM111DINMV51XS1X	EM111DINAV81XS1PFB	CN12
GND (7)	GND (7)	GND
A- (8) / T*(5)	A- (8)	-
B+ (6)	B+ (6)	+
EM111DINAV51XS1X - EM111DINMV51XS1X	7M 24.8.230.0210	CN12
GND (7)	SC	GND
A-(8) / T*(5)	B-	-
B+ (6)	A+	+
EM111DINAV81XS1PFB	EM111DINAV81XS1PFB	CN12
GND (7)	GND (7)	GND
A-(8) / T*(5)	A- (8)	-
B+ (6)	B+ (6)	+
EM111DINAV81XS1PFB	7M 24.8.230.0210	CN12
GND (7)	SC	GND
A-(8) / T*(5)	B-	-
B+ (6)	A+	+
7M 24.8.230.0210	EM111DINAV81XS1PFB	CN12
SC	GND (7)	GND
B-	A- (8)	-
A+	B+ (6)	+
7M 24.8.230.0210	7M 24.8.230.0210	CN12
SC	SC	GND
B-	B-	-
A+	A+	+

Three-Phase.

PowerMeter (DPM)	MIDcounter	eLuxWallbox
EM330DINAV53HS1X	EM340DINAV23XS1PFB	CN12
GND (13)	GND (10)	GND
A-(12) / T*(10)	A-(9)	-
B+ (11)	B+ (8)	+
EM330DINAV53HS1X	7M.38.8.400.0212	CN12
GND (13)	SC	GND
A-(12) / T*(10)	B-	-
B+ (11)	A+	+
EM340DINAV23XS1PFB	EM340DINAV23XS1PFB	CN12
GND (10)	GND (10)	GND
A-(9) / T*(7)	A-(9)	-
B+ (8)	B+ (8)	+
EM340DINAV23XS1PFB	7M.38.8.400.0212	CN12
GND (10)	SC	GND
A-(9) / T*(7)	B-	-
B+ (8)	A+	+
7M.38.8.400.0212	EM340DINAV23XS1PFB	CN12
SC	GND (10)	GND
B-	A-(9)	-
A+	B+ (8)	+
7M.38.8.400.0212	7M.38.8.400.0212	CN12
SC	SC	GND
B-	B-	-
A+	A+	+

*A 120 Ω terminating resistor must be installed on the devices at the ends of the Modbus chain. The resistor is present by default in the **eLuxWallbox**. Gavazzi models have a built-in resistor, which can be enabled by making a jumper between these terminals.

4. PowerMeter (DPM) and MIDcounter configuration

Power on the **PowerMeter (DPM)** and/or the **MIDcounter** when the electrical installation and communication installation are complete. Then proceed with the configuration on the display of the meters.

The configuration varies depending on the model.

4.1. Finder models

The following actions help to understand how to set Finder energy meters:

- Press the touchscreen button (a,b) to move between menus and parameters;
- Long press (~ 2 seconds) the touchscreen button (a,b) to enter and confirm selections

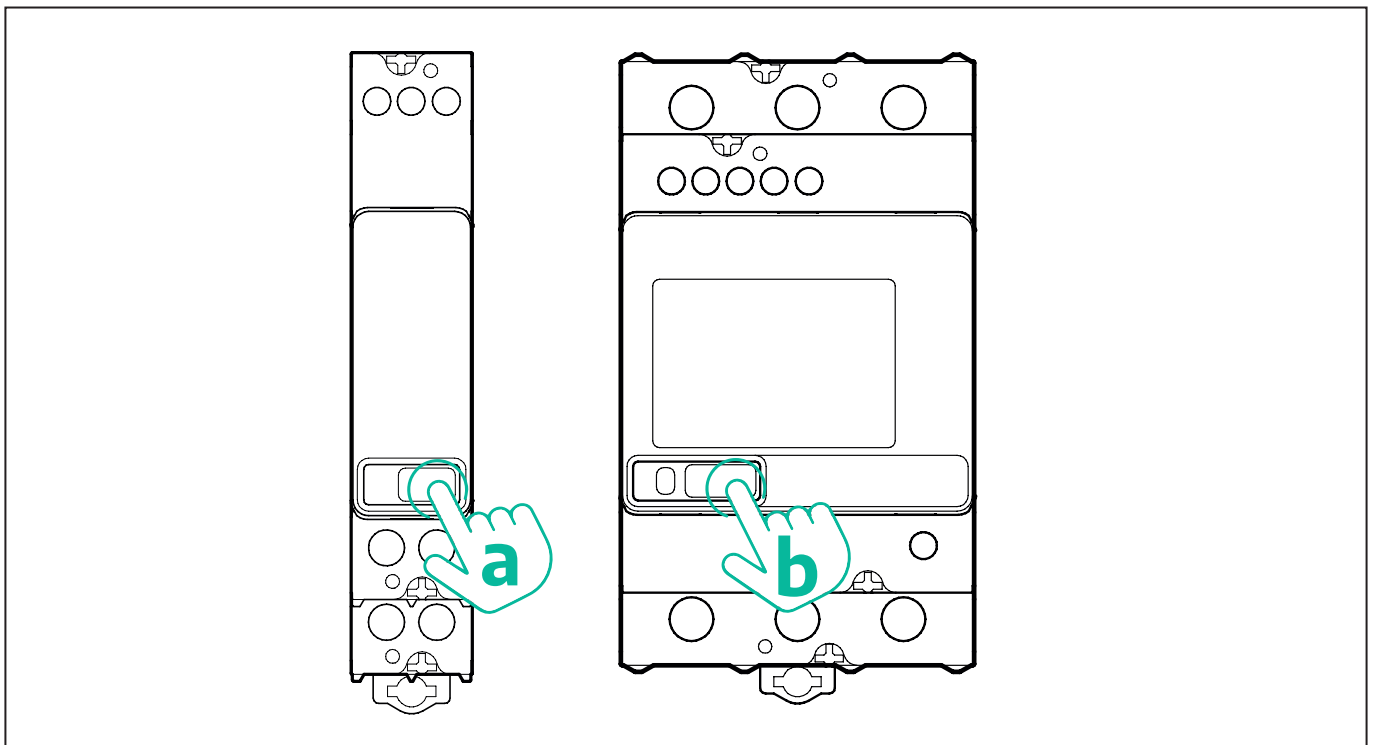

Follow the next steps to correctly configure the single-phase or three-phase Finder energy meters:

- When powering up the energy meter for the first time, long press the touchscreen button (a,b) until the display text blinks in order to enter the "MAIN" menu;
- Scroll the "MAIN" menu pressing the touchscreen button (a,b), then select "SETTING" ("SET" on single-phase meter). Long press to enter the selection.
- Scroll the "SETTING" menu pressing the touchscreen button (a,b), then select "COMMUNICATION" ("COMM" on single phase meter). Long press to enter the selection.
- Insert the correct values indicated in the table below. To modify the value press the touchscreen button (a,b), long press to confirm.

Only for three-phase Finder meter (in addition to previous options):

- Long press the touchscreen button (a,b) until the display text blinks in order to enter the "MAIN" menu (or return to the "MAIN" menu)
- Scroll the "MAIN" menu pressing the touchscreen button (a,b), then select "INSTALLATION". Long press the touchscreen button (a,b) to enter the selection
- Scroll the "INSTALLATION" menu pressing the touchscreen button (a,b) and then select the following option
 - "Communication mode" = "3L+N, L+N-Arithmetic"
 - Once the correct option is confirmed, enter the password: "DCBA" **Attention:** configuration cannot be modified after entering the password **DCBA**
 - Confirm the change selecting "Yes" when prompted.

ALL FINDER MODELS	PowerMeter (DPM)	MIDcounter
DEVICE ADDRESS	1	2
BITS PER SECOND (BAUD)	38400 bit/s	38400 bit/s
PARITY	Even	Even
STOP BIT	1	1
Additional for three-phase type		
	PowerMeter (DPM)	MIDcounter
COMMUNICATION MODE	3L+N, L+N-Arithmetic	3L+N, L+N-Arithmetic
PASSWORD	DCBA	DCBA

4.2. Gavazzi models

The following actions help to understand how to set Gavazzi energy meters:

- Press the touchscreen buttons (c, d, e, g) to move between menus and values
- press (~ 2 seconds) the touchscreen button (d, f) to enter the menu and confirm selections

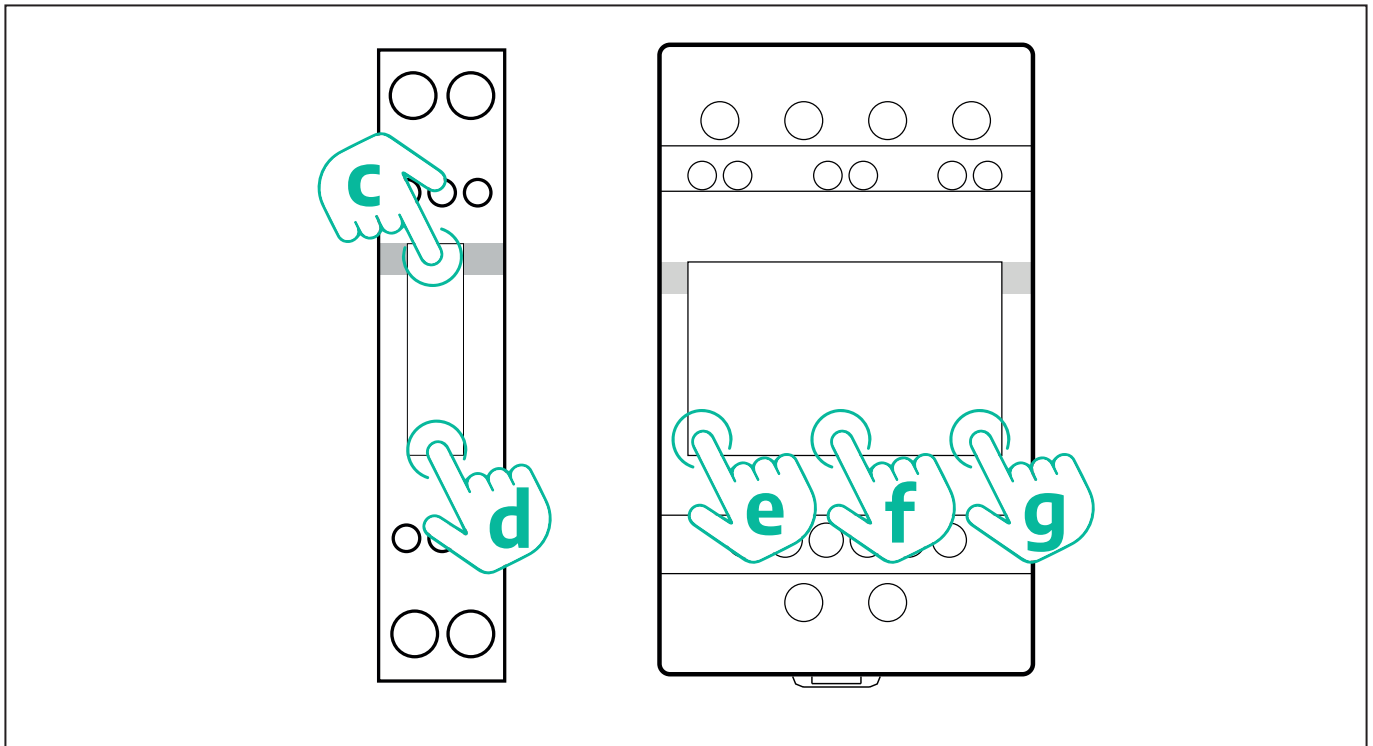

Follow the next steps to correctly configure the single-phase Gavazzi direct and indirect energy meters.

- When powering up the energy meter for the first time, long press the touchscreen button (d) until the password appears on the screen
- Long press the buttons (c, d) simultaneously in order to confirm the password "0000" and enter the "MAIN" menu
- Scroll the "MAIN" menu pressing the upper button (c) and then select the following options in the table below

Follow the next steps to correctly configure the three-phase Gavazzi direct and indirect energy meters:

- When powering up the energy meter for the first time, long press the central button (f) until the password appears on the screen;
- Long press the buttons (e, g) simultaneously in order to confirm the password "0000" and enter the "MAIN" menu
- Scroll the "MAIN" menu pressing the buttons (e or g) and then select the options in the table below

ALL GAVAZZI MODELS	PowerMeter (DPM)	MIDcounter
PASS	0000	0000
ADDRESS	001	002
BAUD	38.4	38.4
PARITY	Even	Even
Additional for three-phase type		
	PowerMeter (DPM)	MIDcounter
SYSTEM	3Pn	3Pn
ADDRESS	001	002

4.3. Device configuration summary

EM340DINAV23XS1PFB / EM330DINAV53HS1X		EM340DINAV23XS1PFB	
PASS	0000	PASS	0000
SYSTEM	3Pn	SYSTEM	3Pn
ADDRESS	1	ADDRESS	2
BAUD	38.4	BAUD	38.4
PARITY	EVEN	PARITY	EVEN

EM111DINAV81XS1PFB / EM111DINAV51XS1X / EM111DINMV51XS1X		EM111DINAV81XS1PFB	
PASS	0000	PASS	0000
ADDRESS	001	ADDRESS	002
BAUD	38.4	BAUD	38.4
PARITY	EVEN	PARITY	EVEN

7M 24.8.230.0210		7M 24.8.230.0210	
DEVICE ADDRESS	__ 1	DEVICE ADDRESS	__ 2
BITS PER SECOND (BAUD)	38400 bit/s	BITS PER SECOND (BAUD)	38400 bit/s
PARITY	EVEN	PARITY	EVEN
STOP BIT	1	STOP BIT	1

7M.38.8.400.0212		7M.38.8.400.0212	
DEVICE ADDRESS	__ 1	DEVICE ADDRESS	__ 2
BITS PER SECOND (BAUD)	38400 bit/s	BITS PER SECOND (BAUD)	38400 bit/s
PARITY	EVEN	PARITY	EVEN
STOP BIT	1	STOP BIT	1
CONNECTION MODE	3L+N, L+N - Arithmetic	CONNECTION MODE	3L+N, L+N - Arithmetic
PASSWORD	DCBA	PASSWORD	DCBA

4.4. PowerMeter (DPM) and MIDcounter configuration on APP

To complete installation, the final configuration of the **eLuxWallbox** and its accessories should be set via the dedicated app

PowerUp is a smartphone app for qualified installers only, available via Google Play™ and Apple Store®. The configuration is carried out via a Bluetooth connection. The wallbox cannot operate correctly if not configured via the app.



NOTICE: Make sure you have the latest version of PowerUp to have access to all of the features.

Follow the instructions below to get started with the app:

Download PowerUp to your smartphone and activate Bluetooth on the smartphone.



Scan **eLuxWallbox** QR code to pair it with the app. The QR Code can be found on the side of the charger.



Once paired, complete the configuration set up of **eLuxWallbox** and its Accessories by clicking on the parameter to be configured.

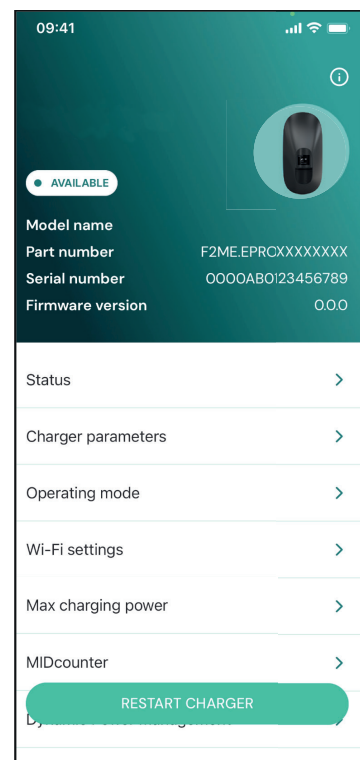

4.5. PowerMeter (DPM) configuration

To complete installation of the **PowerMeter (DPM)**, follow the steps below:

Select "**DPM PowerMeter**" on the homepage

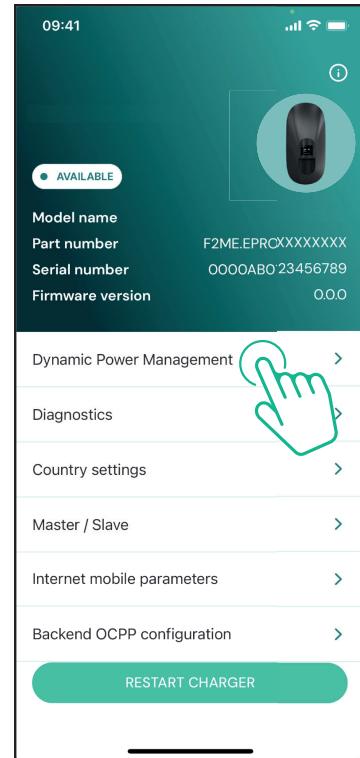

Select the **PowerMeter** type from the drop-down menu, matching the model installed.

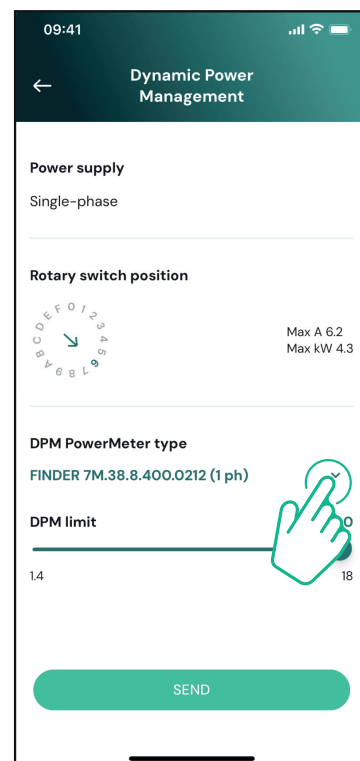

Enter the value of the user contractual power as **DPM** power limit.

For Indirect Meter only - Set the CT current ratio with the slider.

- With CTV 60 A set 60 as Current ratio
- With CTA 100 A set 20 as Current ratio
- With CTA 150 A set 30 as Current ratio

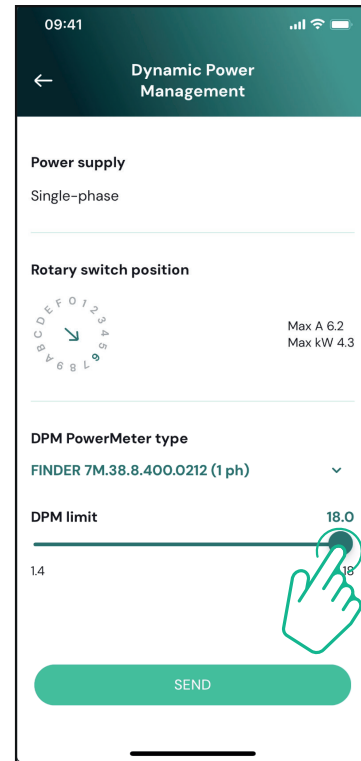

Click "Send" and confirm on the pop-up to restart **eLuxWallbox**.

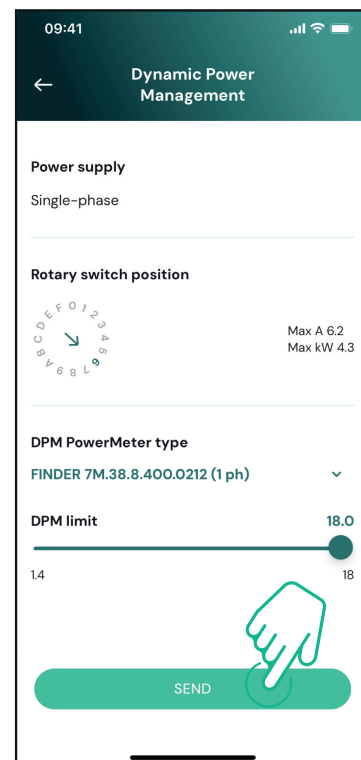

4.6. MIDcounter configuration

To complete installation of the **MIDcounter**, follow the steps below:

Select "**MIDcounter**" on the homepage

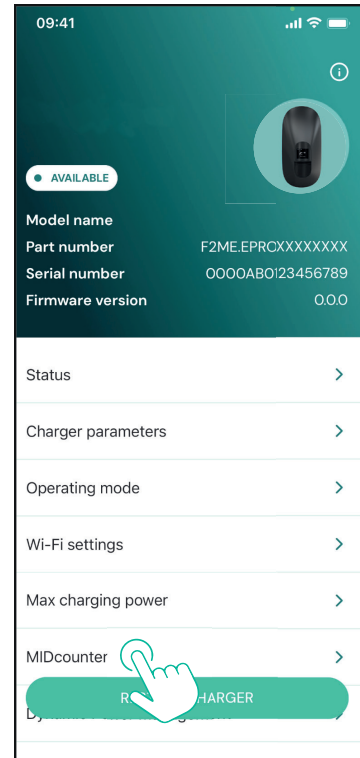

Select the **MIDcounter** type from the drop down menu, based on the model installed.

Select "OFF" from the drop down menu to disable the **MIDcounter** configuration.

Click "Send" to confirm.

To make the changes effective, click on the back arrow in the top left corner and restart **eLuxWallbox** through the dedicated button in the homepage.

If the installation has both the **PowerMeter (DPM)** and the **MIDcounter** it is possible to proceed with **DPM** configuration before restarting.

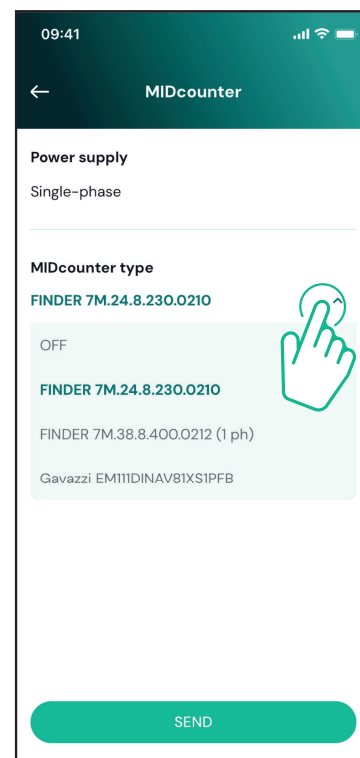

5. TROUBLESHOOTING

Error conditions are stored in the diagnostic logs and shown on the charger panel:

- On the **eLuxWallbox Move** model, the LED bar blinks red. See the **Diagnostic** section of PowerUP or the end-user App for the detailed error code.
- On the **eLuxWallbox** model, the display shows the error code, which is also available in the **Diagnostic** section of PowerUP.

When an error occurs, the charge is interrupted, and the socket is unlocked to allow you to disconnect the plug.

The following table provides a list of errors that can occur and the relative troubleshooting. If the error persists, note the serial number on the charger label and contact Customer Service.

Error code / issue	"Error Description"	Troubleshooting
100	Lack of power supply	<p>Check if the circuit breaker is ON. Check that the CN1 cabling is correct. Check the voltage in CN1.</p>
101	Overheating	<p>Disconnect the Type 2 cable, wait for the temperature to drop, then the error will clear.</p> <p>To restart the charging session, plug in the cable again. Make sure that installation site is compatible with temperature range (25°C/+50°C without direct exposure to sunlight)</p>
102	Communication error between MCU and MPU.	<p>Restart the charger from the circuit breaker, leaving the charger switched off for at least 60 seconds.</p>
103	Hardware fault, ground protection device error (GPD error)	<p>Check the cabling on CN1:</p> <ul style="list-style-type: none"> - in single-phase, make sure that ground cable is connected to PE, the Neutral cable is connected to N and the phase cable to T - in three-phase, make sure that the ground cable is connected to PE, the Neutral cable is connected to N and the phase cables L1, L2 and L3 are connected to T, S, and R. <p>Check whether the voltage difference between PE and N does not exceed 10V. Check PE connection</p> <p>If all connections are checked and the error persists, open the charger and modify the configuration of the Dipswitch (SW2) connector.</p>

104	Hardware fault, residual current monitor AC error. (RCM AC trip)	<p>Try to start a new charging session, removing and plugging in all the connectors.</p> <p>If the problem persists, check for the presence of any problems in the charging cable or vehicle inlet.</p> <p>If the cables and the EV don't show any problem, check CN27 connector and RCM cable.</p>
105	Hardware fault, residual current monitor DC error. (RCM DC trip)	<p>Check that the problem is not with the cable or vehicle. If possible, try another charging session with a different cable or vehicle.</p>
106	Internal meter error	<p>Restart the charger from the circuit breaker, leaving the charger switched off for at least 60 seconds.</p>
107	PowerMeter (DPM) communication error	<p>Check that the communication configuration on the DPM PowerMeter device is correct.</p> <p>Check that the DPM model configuration in the installer App is correct.</p> <p>Check the communication cable wiring on CN12.</p> <p>Check that the communication cable used is suitable for Modbus RS485 and cable length.</p>
108	Configuration Error, Rotary switch position (supply type) is not consistent with the DPM/ MID type.	<p>Check the position of the rotary switch. If it is not consistent with the 1-ph/3-ph installation, change it according to the table in the manual, then restart the charger.</p> <p>If the accessories (DPM/MID) are not installed, make sure that the function is disabled in the installer App.</p> <p>If the accessories (DPM/MID) are installed, check that the correct model is selected on the installer App. Then restart the charger.</p>
109	Main/secondary RS485 communication error	<p>Check the configuration of the Main/Secondary set up from installer App.</p> <p>Check that the Main charger is available.</p> <p>Check that the wiring of the communication cable on CN9 and CN10 is correct.</p> <p>Check that the communication cable used is suitable for Modbus RS485.</p>

110	MIDcounter communication error	<p>Check that the communication configuration on the MIDcounter device is correct.</p> <p>Check the communication cable wiring on CN12.</p> <p>Check that the communication cable used is suitable for Modbus RS485.</p> <p>Check that the MID model configuration in the installer App is correct.</p>
300	Inconsistency between the charger contactor command and feedback	<p>Restart the charger from the circuit breaker, leaving the charger switched off for at least 60 seconds.</p> <p>If error persists even after restart, call Customer Service.</p>
301	Short circuit detected on the Control Pilot line.	<p>With the charger switched off, check that there is no damage and no defects inside and outside the socket (if so, avoid using the charger and contact Customer Service).</p> <p>Check that the problem is not related to the cable or vehicle and try another charge session (with another vehicle or cable if possible).</p>
302	State E or F set on the Control Pilot line.	<p>With the charger switched off, check that there is no damage and no defects inside and outside the cable and its connectors (if so, avoid using it and attempt charge with another cable).</p>
303	Control Pilot disconnected.	<p>Check that the cable connectors are fully inserted inside the charger socket and vehicle inlet.</p>
304	Proximity Pilot disconnected.	<p>Check that the problem is not related to the cable or vehicle and try another charge session (with another vehicle or cable if possible).</p>
305	Broken Proximity Pilot detected.	<p>Check that the problem is not related to the cable or vehicle and try another charge session (with another vehicle or cable if possible).</p>
306	Diode fault detected on Control Pilot line (no - 12V).	<p>Attempt a new charging session unplugging and reinserting the cable from both the charger and vehicle inlet.</p>
307	Control Pilot disconnected.	<p>With the charger switched off, check that there is no damage and no defects inside and outside the cable and its connectors (if so, avoid using it and attempt charge with another cable).</p> <p>Check that the cable connectors are fully inserted inside the charger socket and vehicle inlet.</p> <p>Check that the problem is not related to the cable or vehicle and try another charge session (with another vehicle or cable if possible).</p>

308	Inconsistency between the motor command and feedback, or the motor is in an error condition.	<p>Attempt a new charging session unplugging and reinserting the cable from both the charger and vehicle inlet.</p> <p>Check that the cable connectors are fully inserted inside the charger socket and vehicle inlet.</p>
309	Motor check error during EVSE initialization phase.	Restart the charger from the circuit breaker, leaving the charger switched off for at least 60 seconds.
310	Error detected before charging (PP not detected, or motor fault, or CP not detected).	<p>With the charger switched off, check that there is no damage and no defects inside and outside the cable and its connectors (if so, avoid using it and attempt charge with another cable).</p> <p>Check that the cable connectors are fully inserted inside the charger socket and vehicle inlet.</p>
311	Error detected after charging (motor fault, or CP not disconnected).	Check that the problem is not related to the cable or vehicle and try another charge session (with another vehicle or cable if possible).
312	Emergency stop received from the MPU.	Restart the charger from the circuit breaker, leaving the charger switched off for at least 60 seconds.
313	Current detected during charging, with 100% duty cycle on the Control Pilot line.	Check that the problem is not cable nor vehicle related, attempt a new charging session with another cable and/or charger.
315	Current over limits on phase L1	Unplug the cable, if possible lower the power of charge on the vehicle side and attempt a new charging session.
316	Current over limits on phase L2	
317	Current over limits on phase L3	
318	Voltage below a threshold on phase L1	<p>Check the rotary switch position is consistent with 1-ph/3-ph installation.</p> <p>Check that the voltage on CN1-T is above 196 V.</p> <p>If the voltage is below 196 V, check the electric system or contact the energy supplier.</p> <p>If an error occurs during vehicle charging, try to reduce the set-up charging power and verify that the electric system is correctly dimensioned for the power drawn by the vehicle.</p>

319	Voltage below a threshold on phase L2	The rotary switch is in a three-phase position. Check that the intended installation is in three-phase. If not, select the correct rotary switch position as per Installation Manual.
320	Voltage below a threshold on phase L3	<p>Check that the voltage on CN1-S and R is above 196 V. If the voltage is below 196V, check the electric system or contact the energy supplier.</p> <p>If an error occurs during vehicle charging, try to reduce the set-up charging power and verify that the electric system is correctly dimensioned for the power drawn by the vehicle.</p>
321	Forbidden state change (IEC 61851-1)	<p>EV does not meet IEC 61851-1 standards for starting a charge session.</p> <p>Attempt a new charging session unplugging and reinserting the cable from both the charger and vehicle inlet.</p> <p>If the error persists, contact the vehicle manufacturer.</p>
	Display/LED stuck in Welcome mode (LED blinks red-green-blue)	Restart the charger from the circuit breaker, leaving the charger switched off for at least 60 seconds.
	LED or display does not light up at startup	
	The charger does not start	<p>Let the unit restart, it may take up to 30 seconds.</p> <p>Check if the circuit breaker is ON.</p> <p>Check that the CN1 cabling is correct.</p> <p>Check the voltage in CN1.</p> <p>Restart the charger from the circuit breaker, leaving the charger switched off for at least 60 seconds.</p>
	Cable stuck in the charger socket	Turn off the charger from the circuit breaker, then remove the cable.
	Suspended Charging with solid green LED/ message on the display. The charging session is suspended by the DPM or the EV. The session may resume.	<p>Verify that the max power in the DPM power limit section of the installer App is consistent with the contract power value in kW as indicated in the user's electricity contract. If the value is correct, wait for the charging session to resume or turn off some house loads.</p> <p>In the case of 3-ph installation, verify that the electrical loads are well balanced on the phases of the domestic system.</p>

	<p>App pairing does not complete after QR scan.</p>	<p>Check the integrity of the QR code on the label. Update the App to the latest version. Close and restart the App, then try again. Restart the charger from the circuit breaker, leaving the charger switched off for at least 60 seconds.</p>
--	---	---

6. CLEANING

Cleaning the outside of the device is always recommended when necessary and should be carried out using a soft damp cloth with a mild detergent. When finished, wipe off any traces of moisture or liquid with a soft dry cloth.



CAUTION: Avoid strong jets of air or water as well as the use of soaps or detergents that are too harsh and corrosive for the materials of the charger.

7. PACKAGING DISPOSAL



Dispose of packaging in an environmentally friendly manner. The materials used for packaging this product can be recycled and must be disposed of in compliance with the legislation in force in the country of use. The following disposal directions will be found on the packaging based on the type of material.



NOTE: Further information about current disposal facilities can be obtained from local authorities.

8. ASSISTANCE

If you have any questions about the installation of **eLuxWallbox**. For any other information or requests for support, please contact Free2move eSolutions S.p.A. through the relevant section of its website: www.esolutions.free2move.com.

9. DISCLAIMER

Free2move eSolutions S.p.A. will not be held responsible for any damage directly or indirectly caused to people, things or animals due to the failure to comply with all the provisions set out in this Manual, and the warnings regarding the installation and maintenance of **eLuxWallbox**.

Free2move eSolutions S.p.A. reserves all rights to this document, the article and the illustrations it contains. The reproduction, whole or in part, disclosure to third parties or use of its contents is prohibited without the prior written consent of Free2move eSolutions S.p.A.

Any information in this manual may be changed without prior notice and does not represent any obligation on the part of the manufacturer. Images in this manual are for illustrative purposes only and might differ from the delivered product.

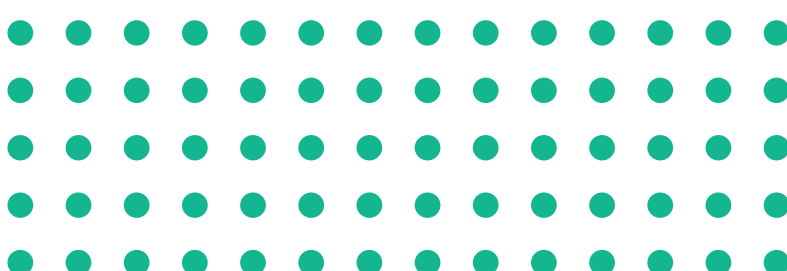

Registered office
Free2move eSolutions S.p.A.
Piazzale Lodi, 3
20137 Milan - Italy
www.esolutions.free2move.com

EN

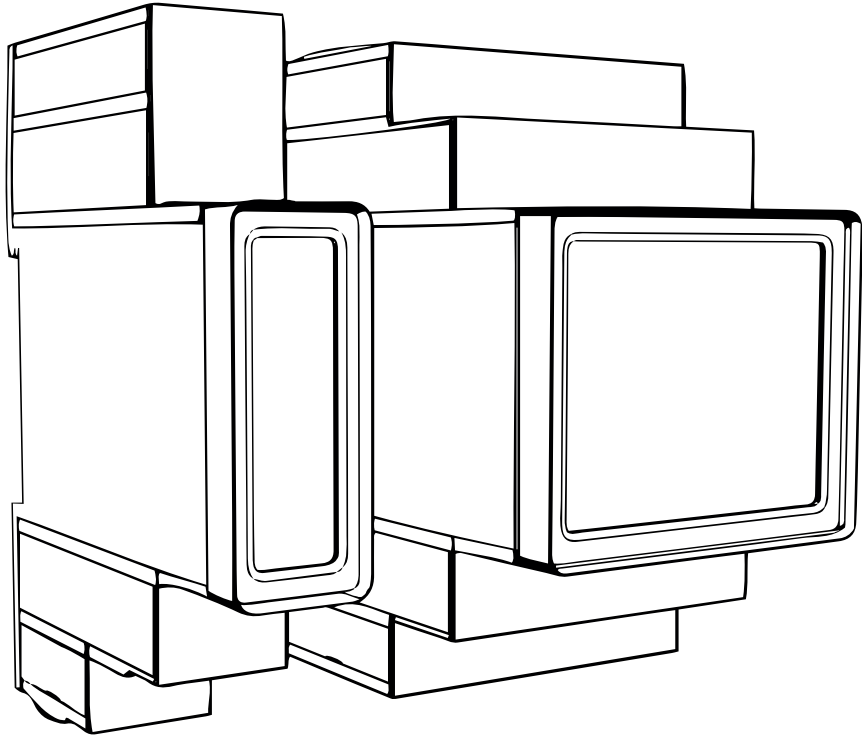
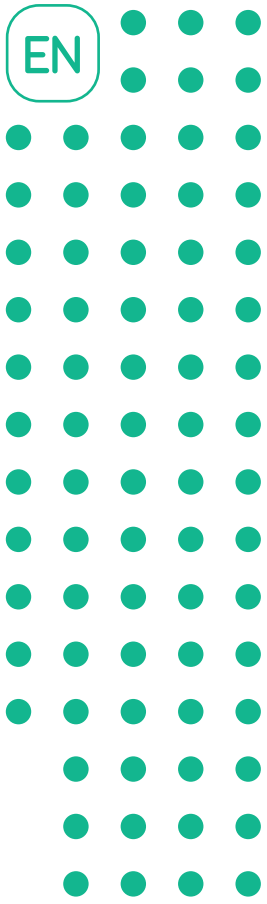

LuxWallbox

Accessories Manual



For safe and proper use,
follow these instructions.
Keep them for future reference

Table of content

1. INTRODUCTION	4
1.1. Purpose of the Manual	4
1.2. Identification of the Manufacturer.....	4
1.3. Structure of the Accessories Manual	4
1.4. Safety	5
1.5. Personal Protective Equipment (PPE).....	6
1.6. Warranty and delivery conditions	6
1.7. List of documents.....	7
1.8. Warnings	7
2. GENERAL INFORMATION	8
2.1. Fields of use	9
3. ACCESSORIES INSTALLATION	10
3.1. Installing PowerMeter (DPM).....	10
3.2. Installing MIDcounter	15
3.3. Communication cable installation	17
3.4. MIDcounter and PowerMeter (DPM) combined installation .	19
4. PowerMeter (DPM) and MIDcounter configuration.	22
4.1. Finder models.....	22
4.2. Gavazzi models.....	24
4.3. Device configuration summary	25
4.4. PowerMeter (DPM) and MIDcounter configuration on APP ..	26
4.5. PowerMeter (DPM) configuration	28
4.6. MIDcounter configuration.....	30
5. TROUBLESHOOTING.....	31
6. CLEANING.....	36
7. PACKAGING DISPOSAL	36
8. ASSISTANCE.....	37
9. DISCLAIMER.....	37



1. INTRODUCTION

1.1. Purpose of the Manual

This installation manual is a guide to help operators to work safely and carry out the installation operations needed to keep the charger in good working order.

The purpose of this document is to support qualified technicians who have received appropriate training, and demonstrated suitable skills and knowledge in the construction, installation, operation and maintenance of electrical equipment.

If the charger is used in a manner not specified in this manual, the protection provided by the charger may be impaired. This document contains the information required for the installation of the charger.

This document has been carefully checked by the Manufacturer Free2move eSolutions S.p.A. but oversights cannot be completely ruled out. If any errors are noted, please inform Free2move eSolutions S.p.A. Except for explicit contractual obligations, under no circumstances may Free2move eSolutions S.p.A. be held liable for any loss or damage resulting from the use of this manual, or from installation of the equipment. This document was originally written in English. In the event of any inconsistencies or doubts, please ask Free2move eSolutions S.p.A. for the original document.

1.2. Identification of the Manufacturer

The manufacturer of the charger is:

Free2move eSolutions S.p.A.

Piazzale Lodi, 3

20137 Milan – Italy

www.esolutions.free2move.com

1.3. Structure of the Accessories Manual





This manual is divided into chapters based on different topics and containing all the information that is needed to install the charger safely.

Each chapter is sub-divided into paragraphs which examine the fundamental points, and each paragraph may have its own title, along with sub-titles and a description.

1.4. Safety

This manual contains important safety instructions that must be followed during installation of the charger.

In order to fulfil this objective, this manual contains a number of precautionary texts, containing special instructions. These instructions are highlighted by a specific text box and are accompanied by a symbol, and are provided in order to ensure the safety of the personnel required to perform the operations described, and to avoid any damage to the charger and/or property:

	<p>This symbol means: DANGER</p> <p>This symbol is intended to highlight a dangerous situation for yourself and others. Read it carefully. Failure to comply with the instruction will result in an imminent hazardous situation which, if not avoided, will result in instant death, or serious or permanent injury.</p>
	<p>This symbol means: WARNING</p> <p>This symbol is intended to highlight safety information. Failure to comply with the instruction will result in a potentially hazardous situation which, if not avoided, could result in death or serious injury.</p>
	<p>This symbol means: CAUTION</p> <p>This symbol is intended to highlight safety information. Read it carefully. Failure to follow these instructions can result in death, serious injury or damage to equipment.</p>
	<p>This symbol means: NOTE</p> <p>Provides additional information to supplement instructions provided.</p>
	<p>This symbol means: NOTICE</p> <p>Provides instructions concerning the use of conduct necessary to handle the operations not associated with possible physical injuries.</p>

Installation must be carried out by qualified personnel. A dedicated, state-of-the-art electricity supply system must be designed and installed, and the system must be certified in compliance with local regulations and the energy supply contract.

Operators are required to read and fully understand this manual, and to comply strictly with the instructions it contains.

Free2move eSolutions S.p.A. cannot be held liable for damage caused to persons and/ or property, or to the equipment, if the conditions described in this document have not been complied with.





WARNING: Installation must be carried out in accordance with the regulations in force in the country of installation, and in compliance with all safety regulations for carrying out electrical work.

1.5. Personal Protective Equipment (PPE)

Personal Protective Equipment (PPE) means any equipment intended to be worn by the workers in order to protect them against one or more hazards likely to threaten their health or safety at the workplace, as well as any device or accessory intended for this purpose.

Since all the PPE indicated in this manual is intended to protect the personnel against health and safety hazards, the Manufacturer of the charger which is the subject of this manual recommends strict compliance with the indications contained in the various sections of this manual.

The list of PPE to be used in order to protect the operators against the residual risks present during the installation and maintenance interventions described in this document is provided below.

Symbol	Meaning
	Wear protective gloves
	Wear anti-static footwear



WARNING: It is responsibility of the operator to read and understand local regulations and evaluate the environmental conditions of the installation site in order to comply the need to wear additional PPE.

1.6. Warranty and delivery conditions

The warranty details are described in the Terms and Conditions of Sale included with the purchase order for this product and/or in the packaging of the product.

Free2move eSolutions S.p.A. assumes no responsibility for failure to comply with the instructions for proper installation, and cannot be held responsible for systems upstream or downstream of the equipment supplied.

Free2move eSolutions S.p.A. cannot be held responsible for defects or malfunctions deriving from: improper use of the charger; deterioration due to transport or particular environmental conditions or installation by unqualified persons.

Free2move eSolutions S.p.A. is not responsible for any disposal of the equipment, or parts thereof, that does not comply with the regulations and laws in force in the country of installation.



NOTICE: Any modification, manipulation or alteration of the hardware or software not expressly agreed with the manufacturer will immediately void the warranty.

1.7. List of documents

In addition to this manual, product documentation can be viewed and downloaded by visiting: www.esolutions.free2move.com.

1.8. Warnings



DANGER: Risk of electric shock and fire. Installation must be carried out in accordance with the regulations in force in the country of installation, and in compliance with all safety regulations for carrying out electrical work.

- Before installing or using the device, make sure that none of the components have been damaged. Damaged components can lead to electrocution, short circuits, and fire due to overheating. A device with damage or defects must not be used.
- Install **eLuxWallbox** away from petrol cans or combustible substances in general.
- Before installing **eLuxWallbox compatible accessories**, ensure the main power source has been disconnected.
- The **eLuxWallbox compatible accessories** must only be used for the specific applications they are designed for.
- Installation not carried out correctly may pose risks to the user.
- The charger must be connected to a mains network in compliance with local and international standards, and all the technical requirements indicated in this manual.
- Children or other persons not able to gauge risks related to the installation of the charger could suffer serious injury or put their lives at risk.
- Pets or other animals must be kept away from the device and packaging material
- Children must not play with the device, accessories or packaging provided with the product.
- The only part that can be removed from **eLuxWallbox**, is the removable cover. Access under the cover is only permitted by qualified personnel during installation, dismantling or maintenance.
- **eLuxWallbox** can only be used with an energy source.
- Necessary precautions to ensure safe operation with Active Implantable Medical Devices must be taken. To determine whether the charging process could adversely affect the medical device, please contact its manufacturer.

2. GENERAL INFORMATION

eLuxWallbox is an Alternate Current charging solution for powering electric vehicles and hybrid plug-ins, and is ideal for semi-public and residential use. The charger is available in three-phase or single-phase configurations and is equipped with a Type 2 socket.

The charger charges electric vehicles up to 22 kW in three-phase, or up to 7.4 kW in single-phase. The charger includes connectivity options such as remote monitoring via the eSolutions control platform (CPMS). Its final configuration must be completed using the **PowerUp** application. For the end user, the **eLuxWallbox** can be managed via the dedicated user's eSolutions Charging App. Both applications are available on Google Play™ and Apple Store®.

This charger is equipped with a SIM card for connection to the 4G mobile network.

The SIM card is automatically activated the first time the charger is turned on.

This document describes how to install the external accessories compatible with the **eLuxWallbox**.

The external accessories described in this manual are:

- **PowerMeter (DPM)**: an energy meter that enables the Dynamic Power Management (**DPM**) which is a smart function that allows an electric vehicle to be recharged using only the power available at home, modulating the charging power and avoiding unpleasant blackouts.
- **MIDcounter**: a certified energy meter that allows to monitor the consumption of the **eLuxWallbox** during each charging session.

This manual contains a description of the characteristics of the different accessories, information on models, installation process and final configuration of the devices.

The **eLuxWallbox** is configured to be used with the following electrical accessories: **PowerMeter (DPM)** or **MIDcounter**:

- Gavazzi, 1-phase, Direct, 32 A
- Finder, 1-phase, Direct, 40 A
- Gavazzi, 3-phase, Direct, 65 A
- Finder, 3-phase, Direct, 80 A

PowerMeter (DPM):

- Gavazzi, 1-phase, Indirect with 1x CT 100 A
- Gavazzi, 1-phase, Indirect with 1x CTV 60 A
- Gavazzi, 3-phase, Indirect with 3x CT 150 A



WARNING: Do not try to install the Electrical Accessories if you are not qualified as a professional electrician. To do so could cause serious danger and harm to you and to the people, property or animals around you.

To complete the installation, it is necessary to configure the **eLuxWallbox** through the dedicated apps:

	Installer's app: PowerUp
Product versions (EU):	EPRO23S224GWBAX
Product versions (UK):	EPRO23S224GWBAS



WARNING: Only Electrical Accessories suggested by Free2move eSolutions S.p.A. are compatible. Installation must be performed by qualified personnel in accordance with local regulations.

2.1. Fields of use

Free2move eSolutions S.p.A. declines all liability for any damage whatsoever due to incorrect or careless actions.

The charger may not be used for any purpose other than the one it is intended to fulfill.

The equipment must not be used by children or people with limited mental or physical abilities, or even by adults or expert professionals if the charger undergoes operations that do not comply with this manual and accompanying documentation.

The charger is a charging device for electric vehicles; the following classification (according to IEC 61851-1) identifies its characteristics:

- Power supply: permanently connected to the AC power supply grid
- Output: Alternate Current
- Environmental conditions: indoor / outdoor use
- Fixed installation
- Protection against electric shock: Class I
- EMC Environment classification: Class B
- Charging type: Mode 3 according to the IEC 61851-1 standard
- Optional function for ventilation not supported

3. ACCESSORIES INSTALLATION

To install the electrical accessories, it is necessary to use Modbus communication cables with the following characteristics:

- Modbus RS485 twisted STP 2x2 AWG24 or S/FTP cat.7 suitable for installation with a 400V power line
- Conductor size: 0.5 mm²
- Stripping length: 10 mm
- Recommended maximum length: 150 m

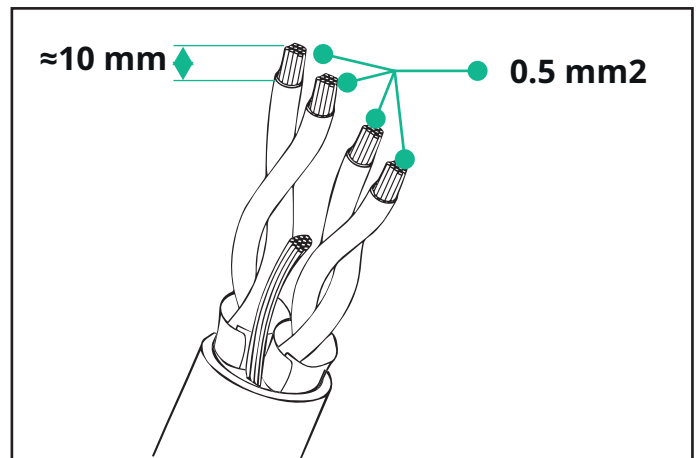

3.1. Installing PowerMeter (DPM)

PowerMeter (DPM) is an energy meter that enables the Dynamic Power Management (**DPM**) which is a smart function that allows an electric vehicle to be recharged using only the power available at home, modulating the charging power and avoiding unpleasant blackouts. Whenever other appliances are being used during the charging session, the system can modulate the charging power towards the car, even temporarily suspending the charging session. As soon as the other domestic appliances are switched off, the session will resume.

The **DPM** smart logic works both in three-phase and in single-phase installations.



WARNING: When installing in three-phase systems, make sure that the electrical loads (including the wallbox) are well balanced between the phases of the electrical system.



WARNING: Before carrying out any installation or maintenance work on the device, it must be ensured that the power supply is switched off.

For Direct models of the PowerMeter (DPM):

Place the **PowerMeter (DPM)** after the main utility meter. The **PowerMeter (DPM)** must measure all the electrical loads, including the **eLuxWallbox**.

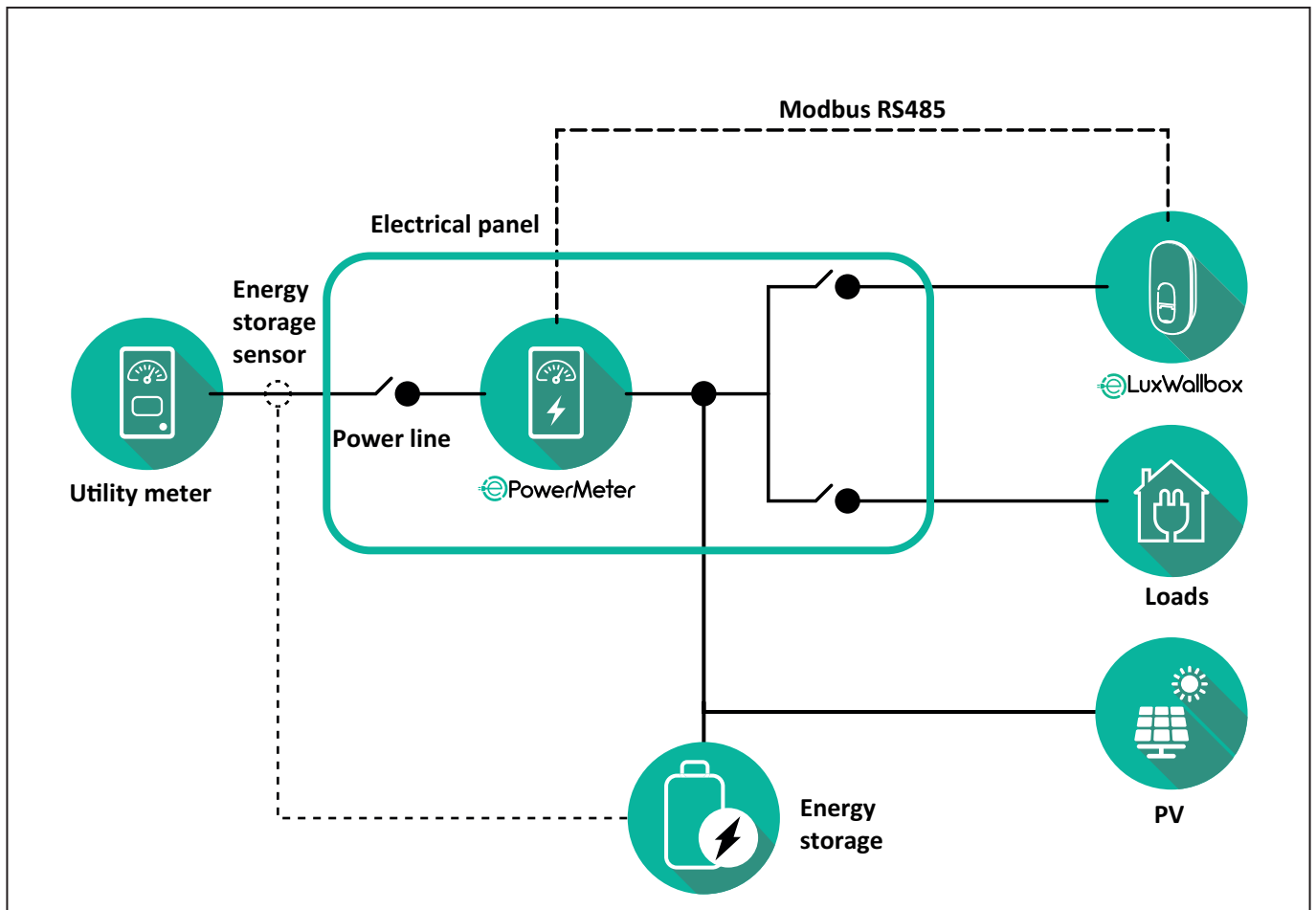

For Direct models of the PowerMeter:



WARNING: During the installation always refer to the manufacturer installation manual provided with the meter.



NOTE: For the single-phase or three-phase electrical connection of the Direct **PowerMeter**, please refer to the diagrams below.

Finder model 1ph and 3ph

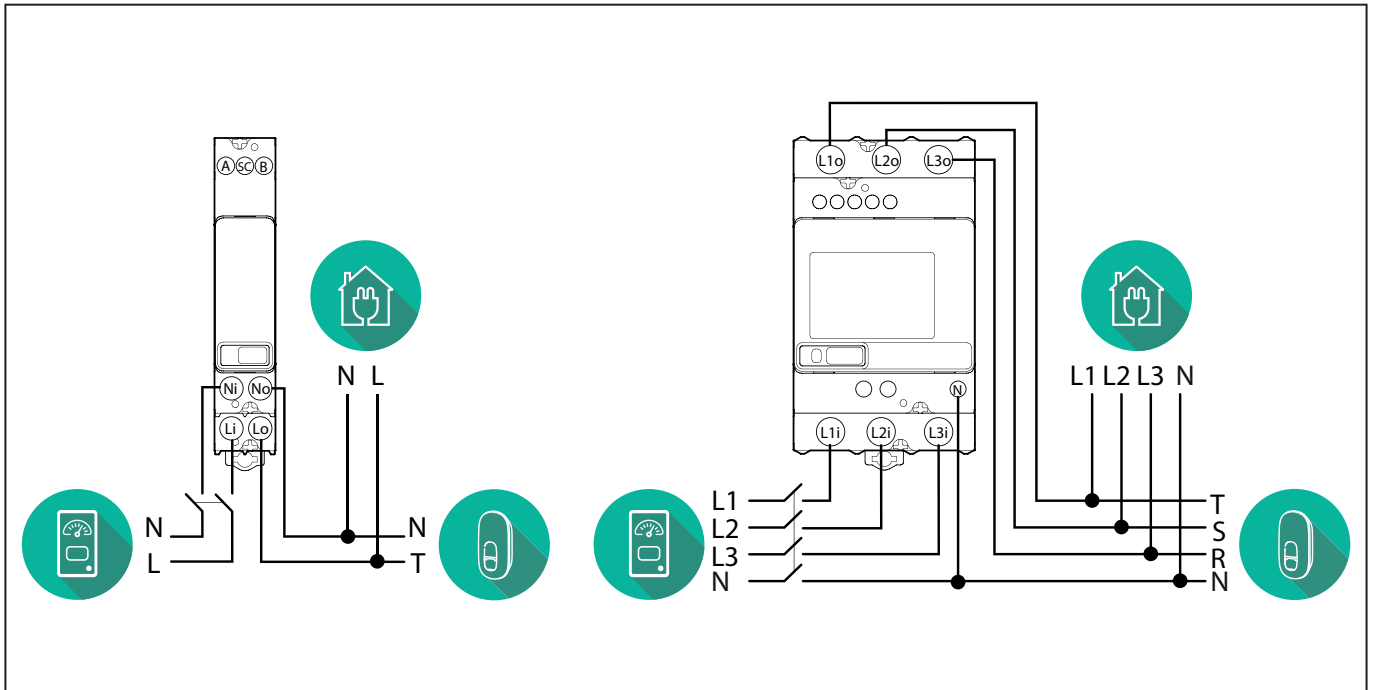

Gavazzi model 1ph and 3ph

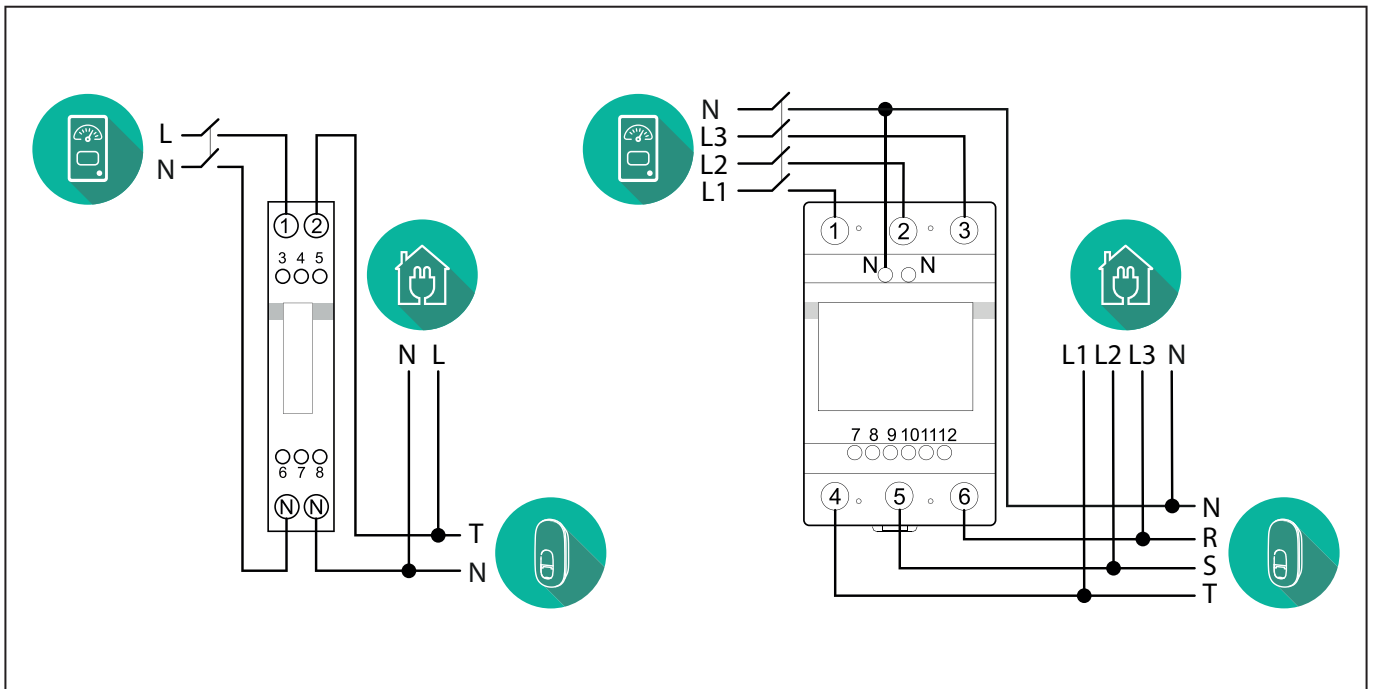

NOTICE:



- 1) If PV is present, the **PowerMeter** should be placed between the Utility Meter and the PV connection point.
- 2) If there is a home Energy storage, the **PowerMeter** should be placed between the Energy storage connection point and the Energy storage measurement sensor.

For Indirect models of the PowerMeter:

Place the CT (current transformer) of the **PowerMeter** after the main utility meter and before the main switch of the house/building. The current transformer must measure all the domestic loads, including the **eLuxWallbox**.

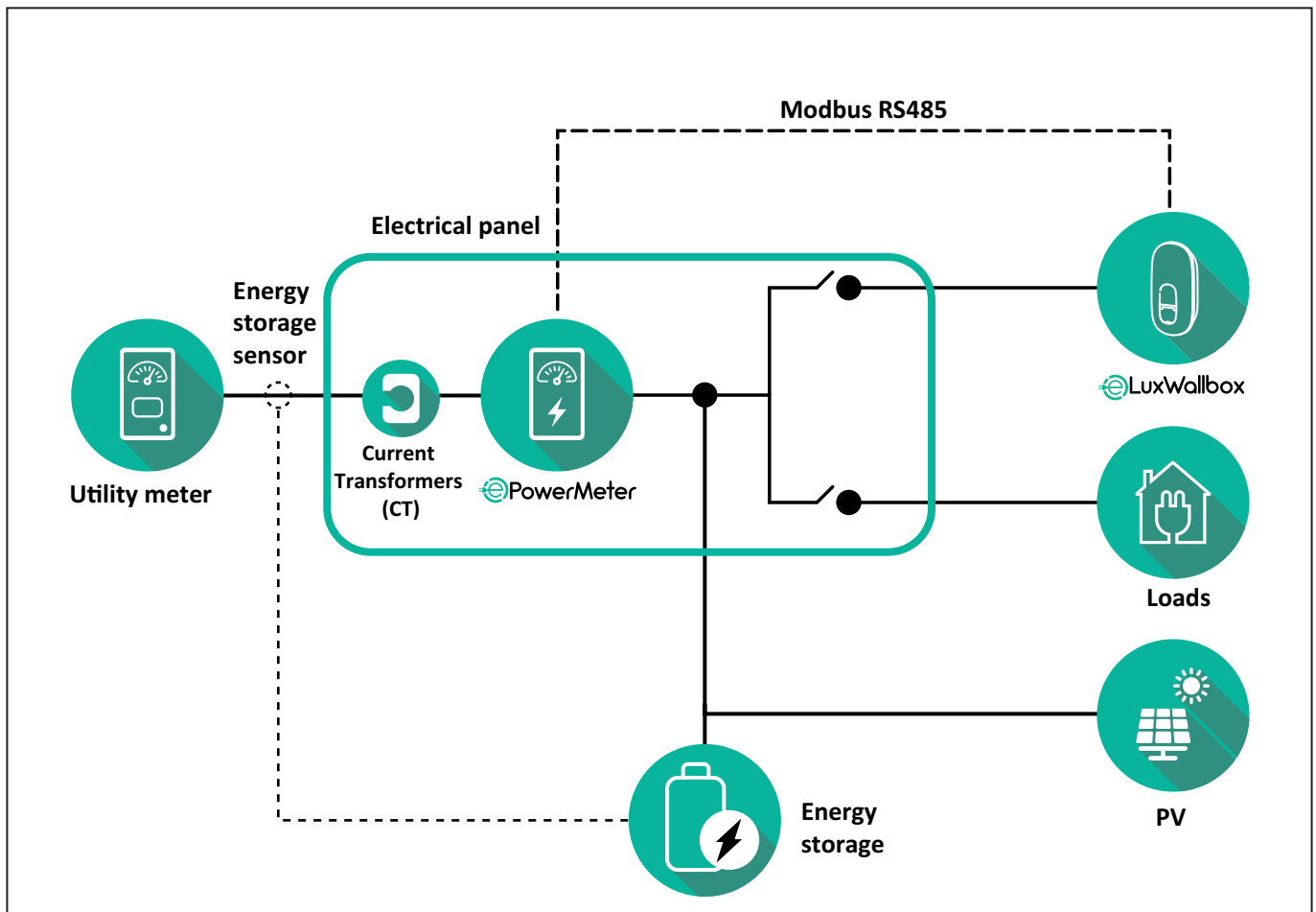

NOTICE:



1) If PV is present, the **PowerMeter** Current Transformers (CT) should be placed between the PV connection point and the Utility Meter.

2) If there is a home Energy storage, the **PowerMeter** Current Transformers (CT) should be placed between the Energy storage connection point and the Energy storage measurement sensor.

Connect the Current Transformers (CT) as indicated in the meter installation manual. Point the arrow on the CT in the direction of the loads.

For the three-phase or single-phase electrical connection of the indirect **PowerMeter**, refer to the diagrams below.

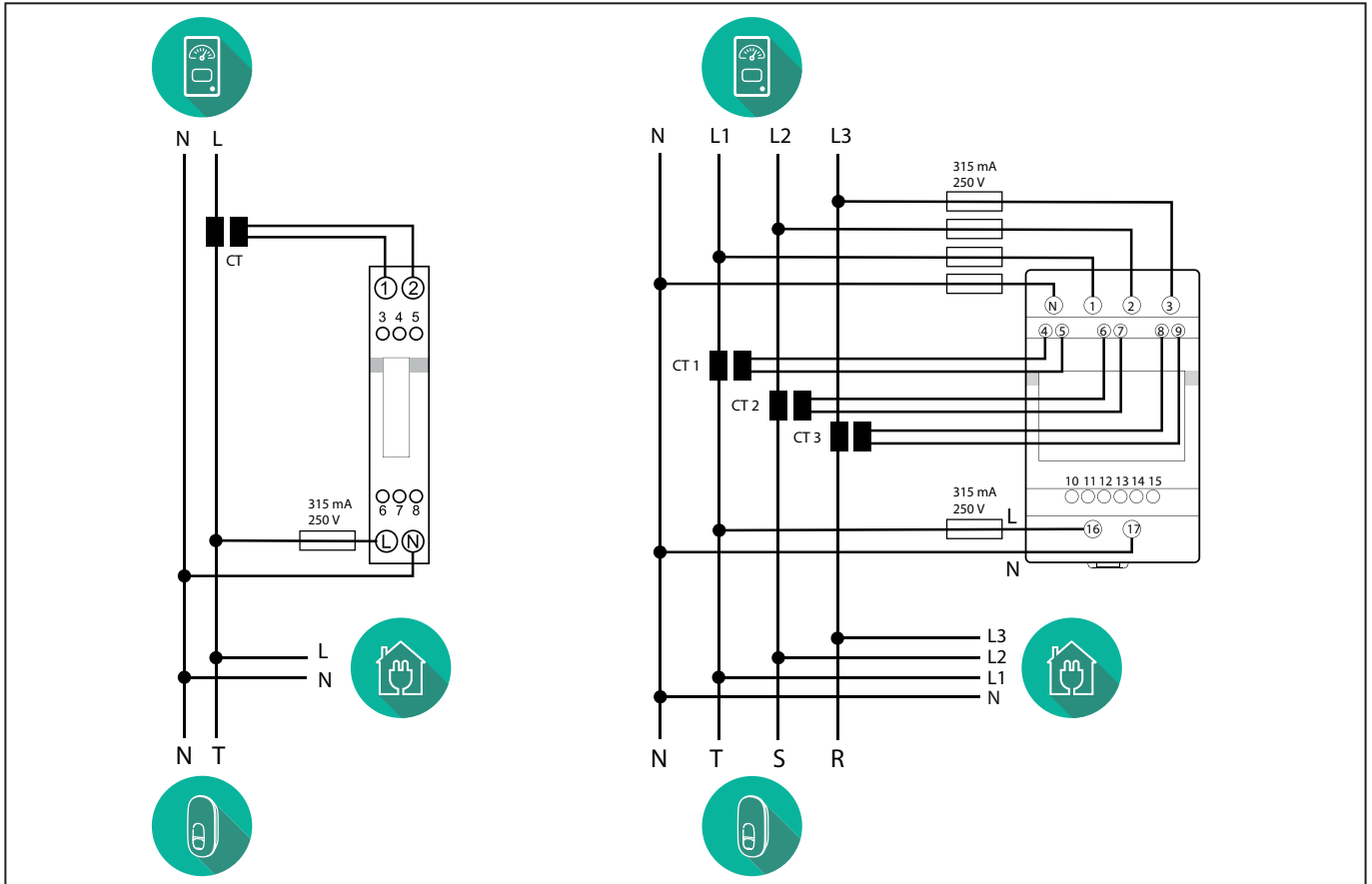

3.2. Installing MIDcounter

The **MIDcounter** is a certified energy meter that allows the consumption of the charger to be safely and reliably monitored during each charging session.

All the relevant data of the charging sessions is automatically recorded by a certified **MID** meter and transferred from the charger to the Charge Point Management System (CPMS).



WARNING: The power to the charger must remain off during this step.

Place the **MIDcounter** on the same power line as the charger, after the electrical protection devices.

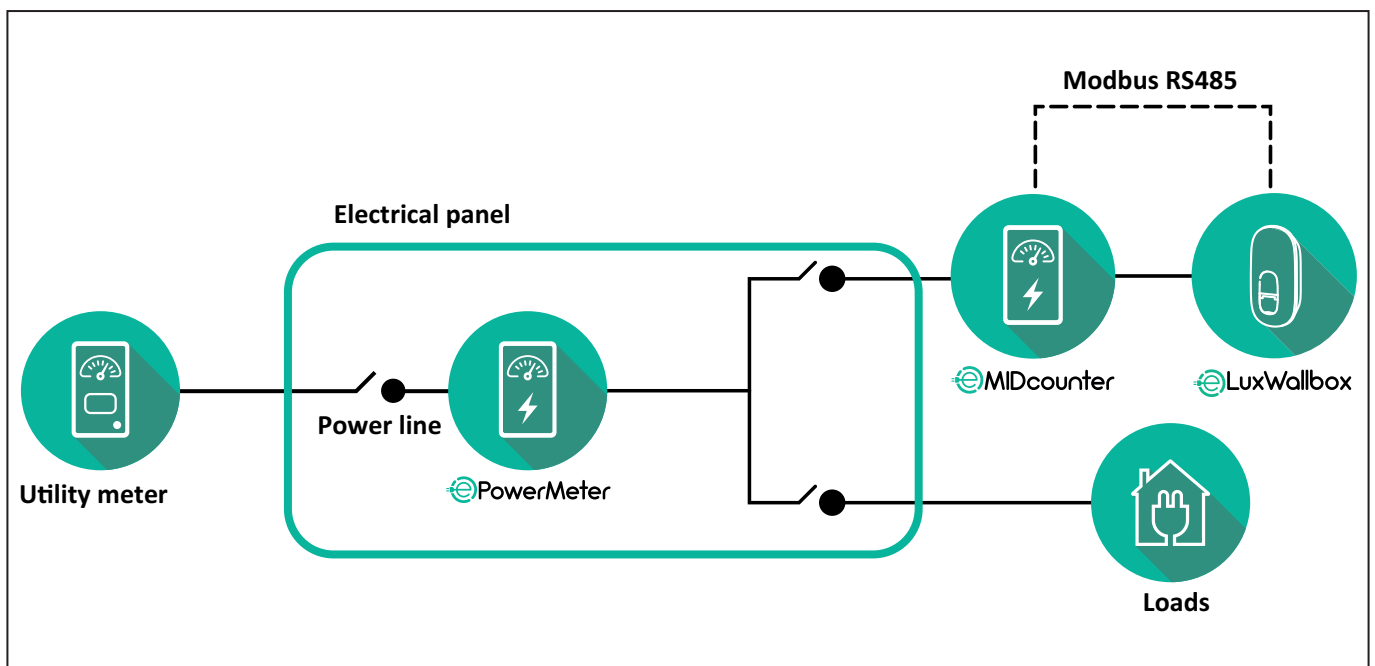

See the diagrams below for single phase and three phase electrical connection of **MIDcounter** (Finder and Gavazzi).

**Finder 1-phase, Direct, 40 A
(7M2482300210)**

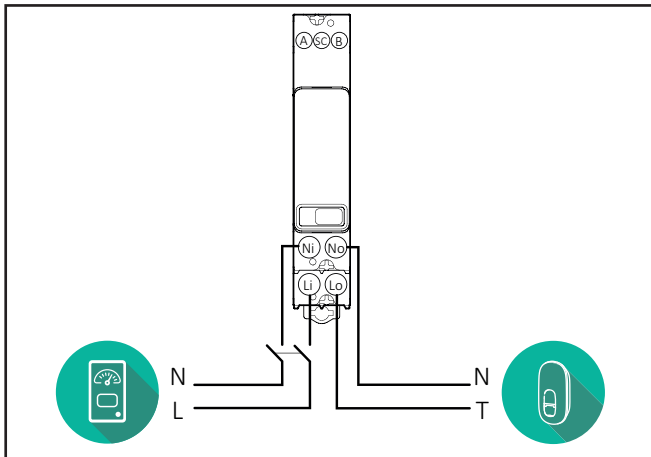

**Gavazzi, 3-phase, Direct, 65 A
(EM340DINAV23XS1PFB)**

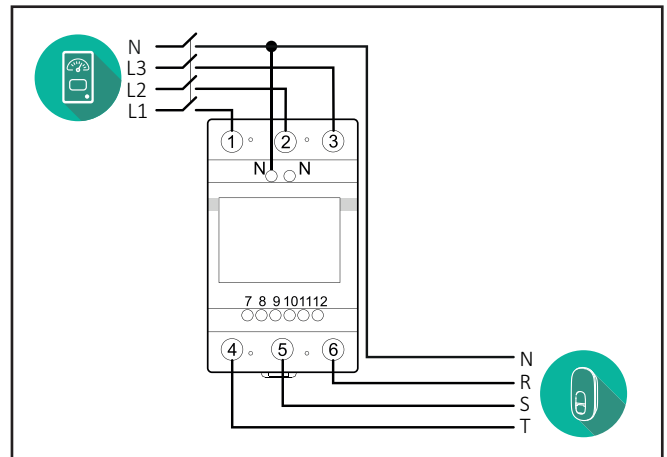

**Finder 3-phase, Direct, 80 A
(7M3884000212)**

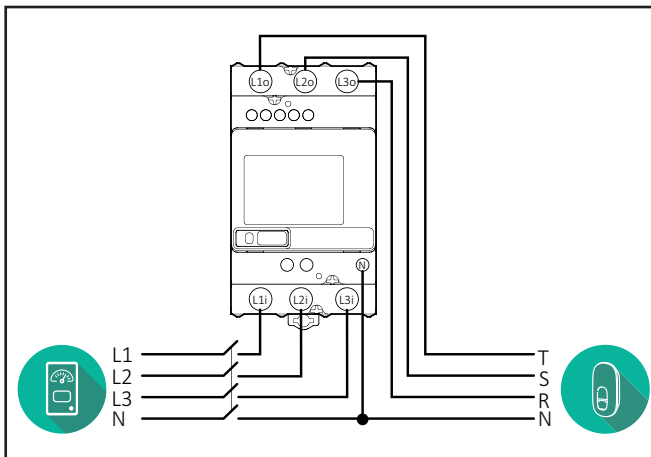

**Gavazzi, 1 phase, Direct, 100 A
(EM112DINAV01XS1PFB)**

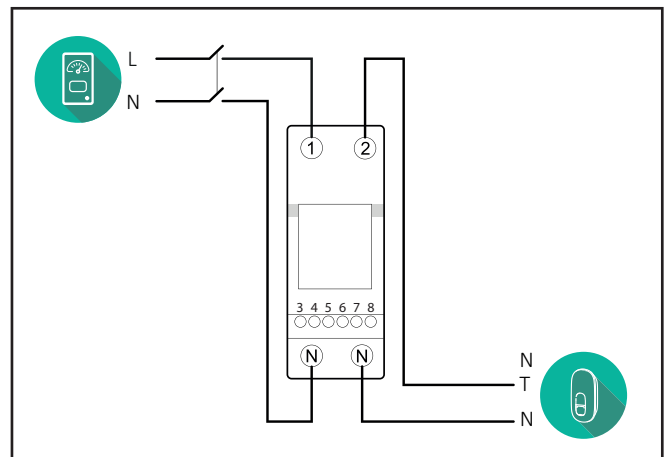

**Gavazzi, 1-phase, Direct, 32 A
(EM111DINAV81XS1PFB)**

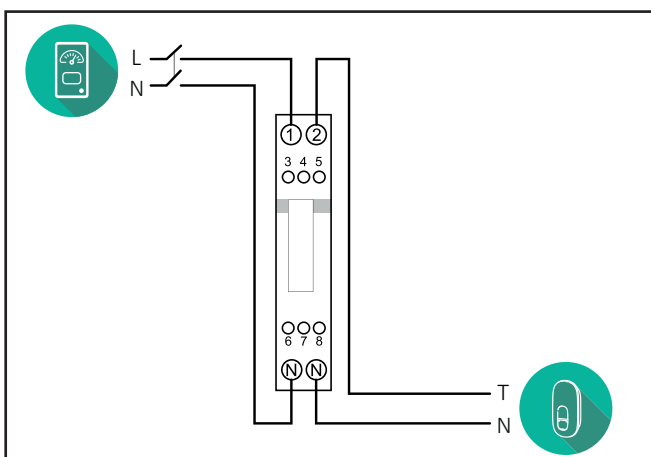

3.3. Communication cable installation

Install a communication cable between the **PowerMeter (DPM)** and the **eLuxWallbox**.

- On the **eLuxWallbox**, remove the protective cap of the communication cables entry point and insert the \varnothing 25 mm corrugated sheath.
- Tighten the box-cable sheath junction.
- Insert the communication cable, pulling it to a suitable length so that it reaches the communication port CN12, leaving some slack.
- Connect the Modbus RS485 communication cable to the GND, - and + pins of the CN12 connector.



NOTE: It is possible to replace the box-cable sheath junctions with \varnothing 25mm cable gland (not provided by the manufacturer).

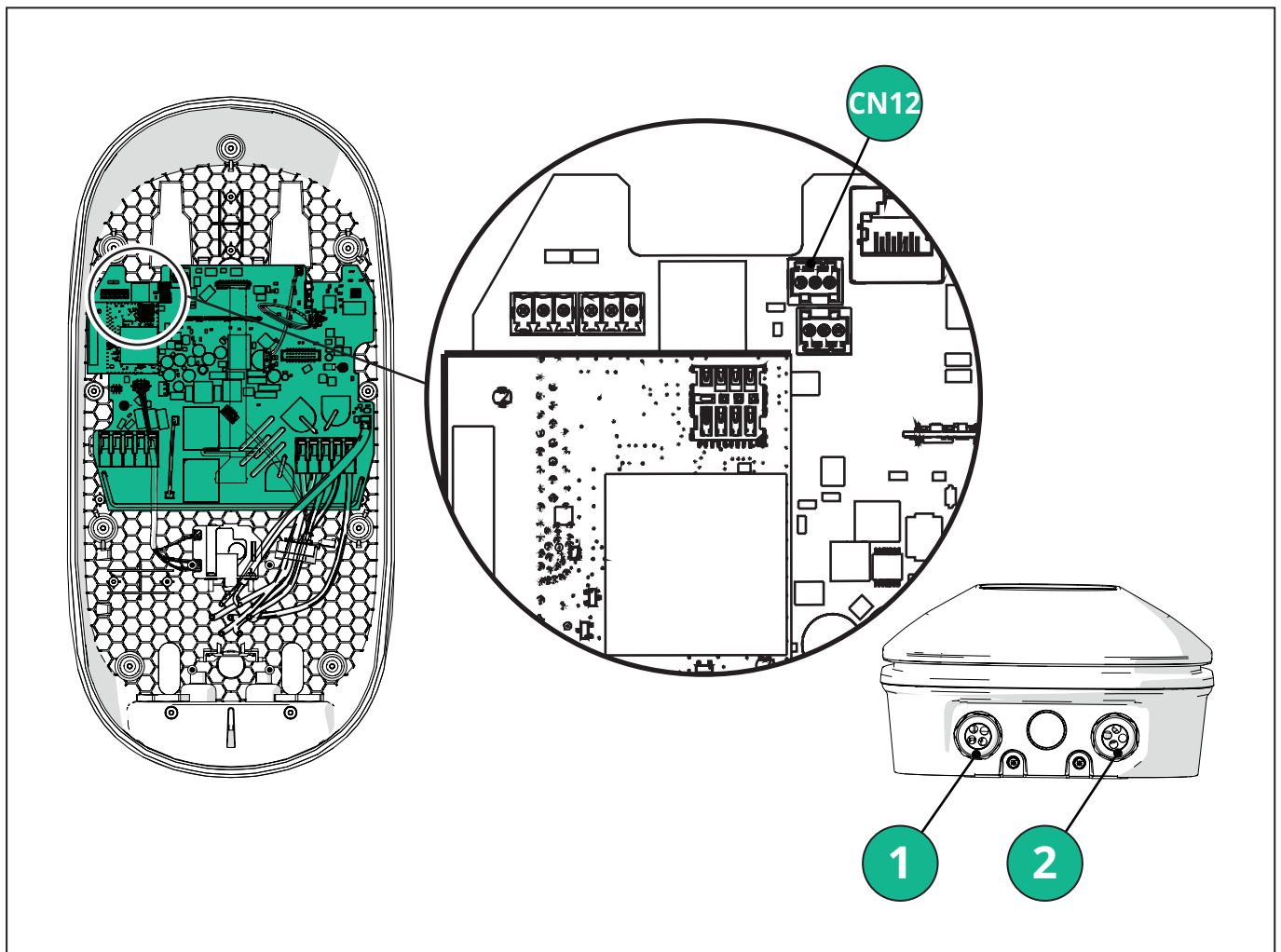

1 - Power supply cables

2 - Communication cables

CN12 - RS485 Modbus for external meter communication (**DPM** and **MID**)

Connect the communication cables in the following order from the **PowerMeter (DPM)** to **eLuxWallbox**.



WARNING: If the installation includes both accessories, follow the instructions for “MIDcounter and PowerMeter (DPM) combined installation”.

CN12	Finder 1ph 7M.24.8.230.0210
GND	SC
-	B
+	A

CN12	Gavazzi 3ph EM340DINAV23XS1PFB
GND	10
-	9
+	8

Junction 9/7

CN12	Finder 3ph 7M.38.8.400.0212
GND	SC
-	B
+	A

CN12	Gavazzi Ind 1ph EM111DINAV51XS1X / EM111DINMV51XS1X
GND	7
-	8
+	6

Junction 8/5

CN12	Gavazzi 1ph EM111DINAV81XS1PFB
GND	7
-	8
+	6

Junction 8/5

CN12	Gavazzi Ind 3ph EM330DINAV53HS1X
GND	13
-	12
+	11

Junction 12/10

3.4. MIDcounter and PowerMeter (DPM) combined installation

If installing both electrical accessories, the positioning of **MIDcounter** together with the **PowerMeter (DPM)** is indicated in the diagram below:

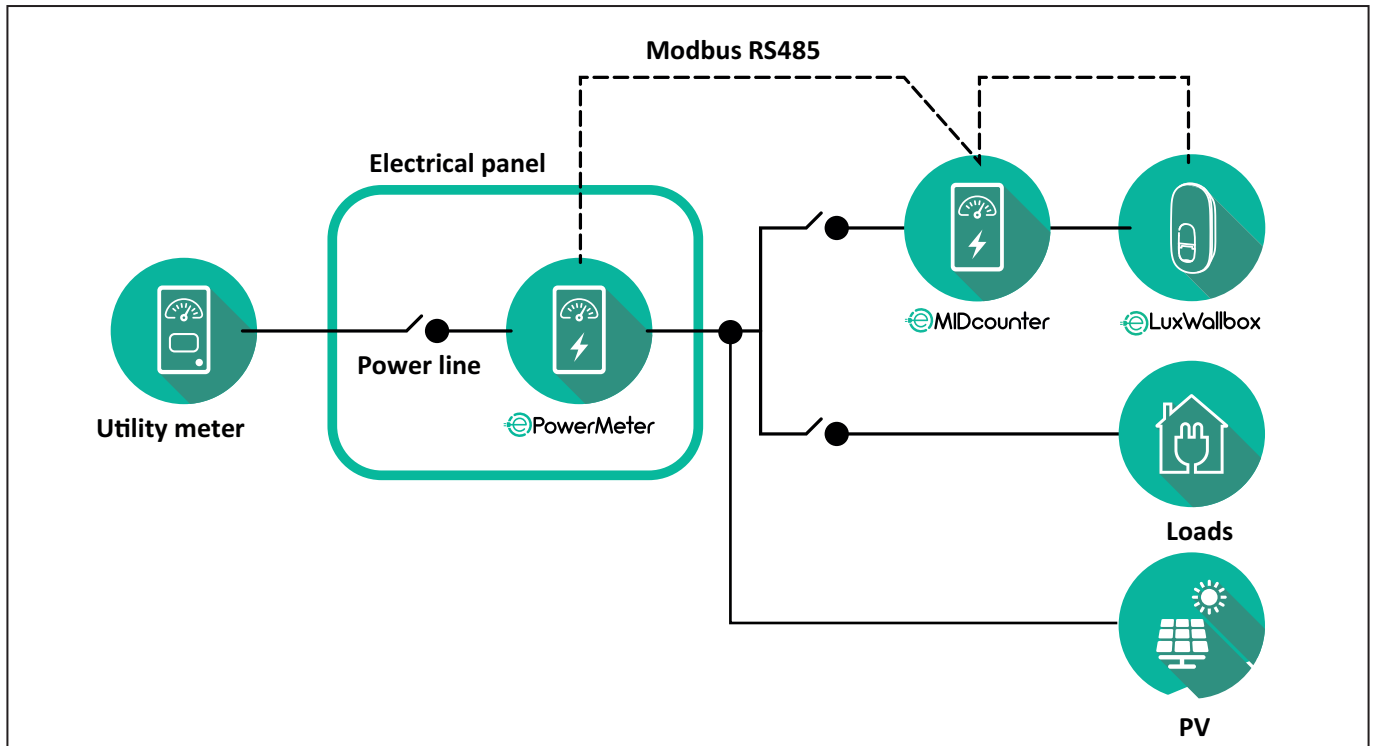

Connect the Modbus communication cables. The **PowerMeter (DPM)**, **MIDcounter** and the **eLuxWallbox** must be connected on the same communication bus in a Daisy chain format.

On the **eLuxWallbox**:

- Remove the protective cap of the communication cable entry point and insert the \varnothing 25 mm corrugated sheath.
- Tighten the box-cable sheath junction.
- Insert the communication cable, pulling it to a suitable length so that it reaches the communication port CN12, leaving some slack.
- Connect the Modbus RS485 communication cable to the GND, - and + pins of the CN12 connector.

Use the table below to connect the communication cables from the accessories to the **eLuxWallbox**.

Single-Phase.

PowerMeter (DPM)	MIDcounter	eLuxWallbox
EM111DINAV51XS1X - EM111DINMV51XS1X	EM111DINAV81XS1PFB	CN12
GND (7)	GND (7)	GND
A- (8) / T*(5)	A- (8)	-
B+ (6)	B+ (6)	+
EM111DINAV51XS1X - EM111DINMV51XS1X	7M 24.8.230.0210	CN12
GND (7)	SC	GND
A-(8) / T*(5)	B-	-
B+ (6)	A+	+
EM111DINAV81XS1PFB	EM111DINAV81XS1PFB	CN12
GND (7)	GND (7)	GND
A-(8) / T*(5)	A- (8)	-
B+ (6)	B+ (6)	+
EM111DINAV81XS1PFB	7M 24.8.230.0210	CN12
GND (7)	SC	GND
A-(8) / T*(5)	B-	-
B+ (6)	A+	+
7M 24.8.230.0210	EM111DINAV81XS1PFB	CN12
SC	GND (7)	GND
B-	A- (8)	-
A+	B+ (6)	+
7M 24.8.230.0210	7M 24.8.230.0210	CN12
SC	SC	GND
B-	B-	-
A+	A+	+

Three-Phase.

PowerMeter (DPM)	MIDcounter	eLuxWallbox
EM330DINAV53HS1X	EM340DINAV23XS1PFB	CN12
GND (13)	GND (10)	GND
A-(12) / T*(10)	A-(9)	-
B+ (11)	B+ (8)	+
EM330DINAV53HS1X	7M.38.8.400.0212	CN12
GND (13)	SC	GND
A-(12) / T*(10)	B-	-
B+ (11)	A+	+
EM340DINAV23XS1PFB	EM340DINAV23XS1PFB	CN12
GND (10)	GND (10)	GND
A-(9) / T*(7)	A-(9)	-
B+ (8)	B+ (8)	+
EM340DINAV23XS1PFB	7M.38.8.400.0212	CN12
GND (10)	SC	GND
A-(9) / T*(7)	B-	-
B+ (8)	A+	+
7M.38.8.400.0212	EM340DINAV23XS1PFB	CN12
SC	GND (10)	GND
B-	A-(9)	-
A+	B+ (8)	+
7M.38.8.400.0212	7M.38.8.400.0212	CN12
SC	SC	GND
B-	B-	-
A+	A+	+

*A 120 Ω terminating resistor must be installed on the devices at the ends of the Modbus chain. The resistor is present by default in the **eLuxWallbox**. Gavazzi models have a built-in resistor, which can be enabled by making a jumper between these terminals.

4. PowerMeter (DPM) and MIDcounter configuration

Power on the **PowerMeter (DPM)** and/or the **MIDcounter** when the electrical installation and communication installation are complete. Then proceed with the configuration on the display of the meters.

The configuration varies depending on the model.

4.1. Finder models

The following actions help to understand how to set Finder energy meters:

- Press the touchscreen button (a,b) to move between menus and parameters;
- Long press (~ 2 seconds) the touchscreen button (a,b) to enter and confirm selections

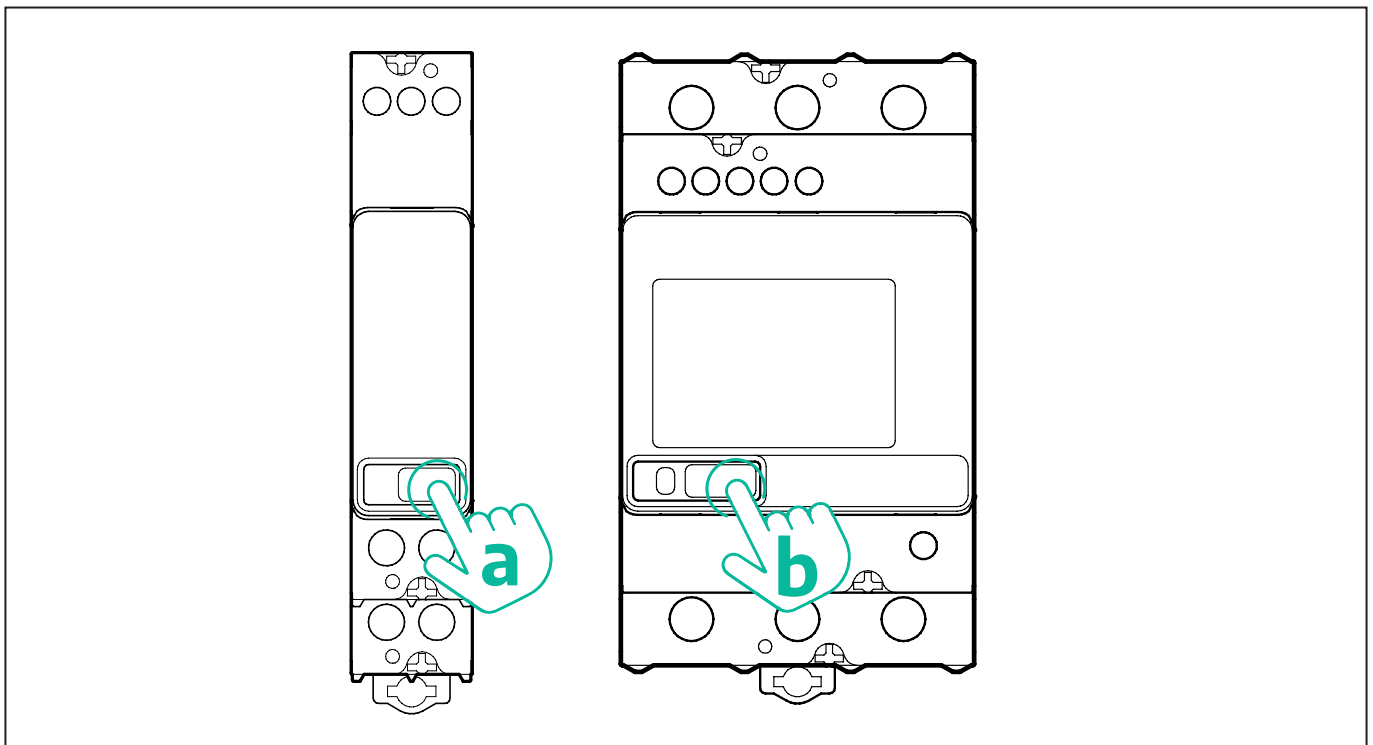

Follow the next steps to correctly configure the single-phase or three-phase Finder energy meters:

- When powering up the energy meter for the first time, long press the touchscreen button (a,b) until the display text blinks in order to enter the "MAIN" menu;
- Scroll the "MAIN" menu pressing the touchscreen button (a,b), then select "SETTING" ("SET" on single-phase meter). Long press to enter the selection.
- Scroll the "SETTING" menu pressing the touchscreen button (a,b), then select "COMMUNICATION" ("COMM" on single phase meter). Long press to enter the selection.
- Insert the correct values indicated in the table below. To modify the value press the touchscreen button (a,b), long press to confirm.

Only for three-phase Finder meter (in addition to previous options):

- Long press the touchscreen button (a,b) until the display text blinks in order to enter the "MAIN" menu (or return to the "MAIN" menu)
- Scroll the "MAIN" menu pressing the touchscreen button (a,b), then select "INSTALLATION". Long press the touchscreen button (a,b) to enter the selection
- Scroll the "INSTALLATION" menu pressing the touchscreen button (a,b) and then select the following option
 - "Communication mode" = "3L+N, L+N-Arithmetic"
 - Once the correct option is confirmed, enter the password: "DCBA" **Attention:** configuration cannot be modified after entering the password **DCBA**
 - Confirm the change selecting "Yes" when prompted.

ALL FINDER MODELS	PowerMeter (DPM)	MIDcounter
DEVICE ADDRESS	1	2
BITS PER SECOND (BAUD)	38400 bit/s	38400 bit/s
PARITY	Even	Even
STOP BIT	1	1
Additional for three-phase type		
	PowerMeter (DPM)	MIDcounter
COMMUNICATION MODE	3L+N, L+N-Arithmetic	3L+N, L+N-Arithmetic
PASSWORD	DCBA	DCBA

4.2. Gavazzi models

The following actions help to understand how to set Gavazzi energy meters:

- Press the touchscreen buttons (c, d, e, g) to move between menus and values
- press (~ 2 seconds) the touchscreen button (d, f) to enter the menu and confirm selections

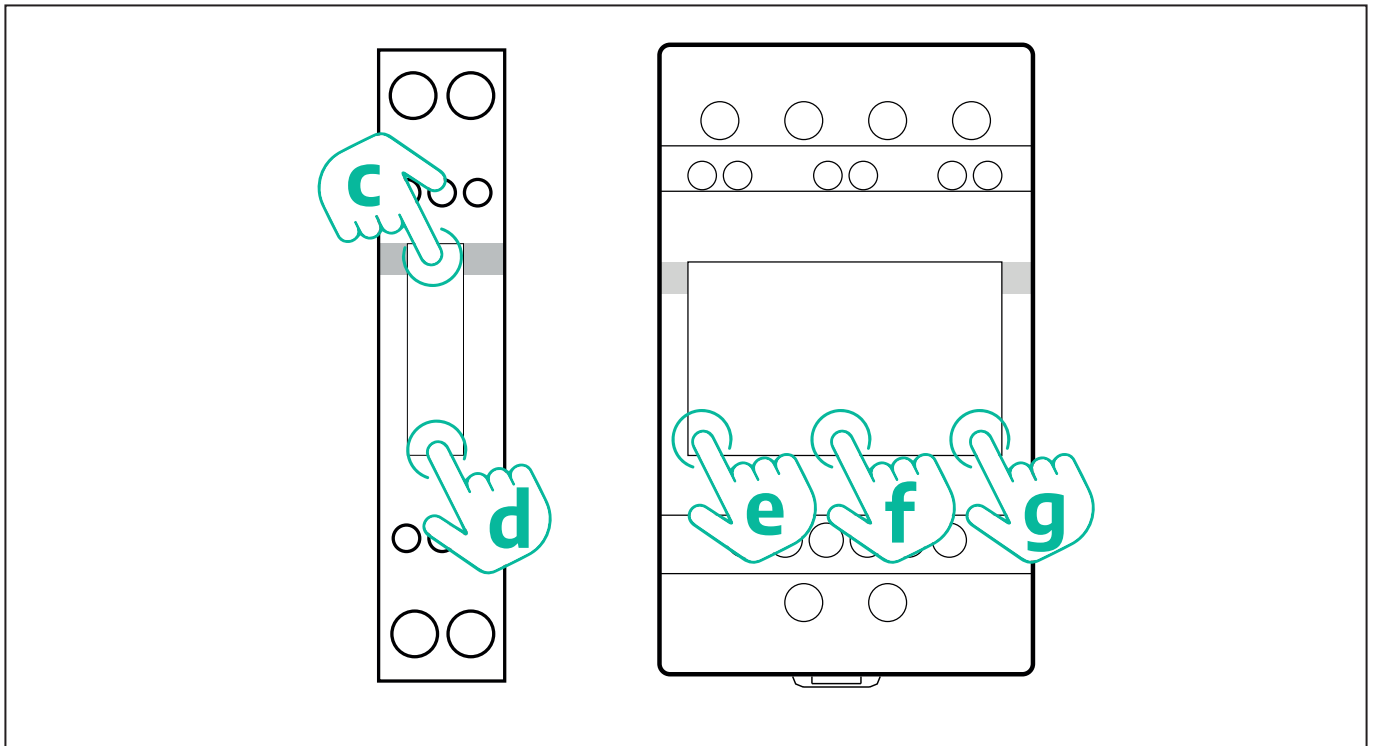

Follow the next steps to correctly configure the single-phase Gavazzi direct and indirect energy meters.

- When powering up the energy meter for the first time, long press the touchscreen button (d) until the password appears on the screen
- Long press the buttons (c, d) simultaneously in order to confirm the password "0000" and enter the "MAIN" menu
- Scroll the "MAIN" menu pressing the upper button (c) and then select the following options in the table below

Follow the next steps to correctly configure the three-phase Gavazzi direct and indirect energy meters:

- When powering up the energy meter for the first time, long press the central button (f) until the password appears on the screen;
- Long press the buttons (e, g) simultaneously in order to confirm the password "0000" and enter the "MAIN" menu
- Scroll the "MAIN" menu pressing the buttons (e or g) and then select the options in the table below

ALL GAVAZZI MODELS	PowerMeter (DPM)	MIDcounter
PASS	0000	0000
ADDRESS	001	002
BAUD	38.4	38.4
PARITY	Even	Even
Additional for three-phase type		
	PowerMeter (DPM)	MIDcounter
SYSTEM	3Pn	3Pn
ADDRESS	001	002

4.3. Device configuration summary

EM340DINAV23XS1PFB / EM330DINAV53HS1X		EM340DINAV23XS1PFB	
PASS	0000	PASS	0000
SYSTEM	3Pn	SYSTEM	3Pn
ADDRESS	1	ADDRESS	2
BAUD	38.4	BAUD	38.4
PARITY	EVEN	PARITY	EVEN

EM111DINAV81XS1PFB / EM111DINAV51XS1X / EM111DINMV51XS1X		EM111DINAV81XS1PFB	
PASS	0000	PASS	0000
ADDRESS	001	ADDRESS	002
BAUD	38.4	BAUD	38.4
PARITY	EVEN	PARITY	EVEN

7M 24.8.230.0210		7M 24.8.230.0210	
DEVICE ADDRESS	__ 1	DEVICE ADDRESS	__ 2
BITS PER SECOND (BAUD)	38400 bit/s	BITS PER SECOND (BAUD)	38400 bit/s
PARITY	EVEN	PARITY	EVEN
STOP BIT	1	STOP BIT	1

7M.38.8.400.0212		7M.38.8.400.0212	
DEVICE ADDRESS	__ 1	DEVICE ADDRESS	__ 2
BITS PER SECOND (BAUD)	38400 bit/s	BITS PER SECOND (BAUD)	38400 bit/s
PARITY	EVEN	PARITY	EVEN
STOP BIT	1	STOP BIT	1
CONNECTION MODE	3L+N, L+N - Arithmetic	CONNECTION MODE	3L+N, L+N - Arithmetic
PASSWORD	DCBA	PASSWORD	DCBA

4.4. PowerMeter (DPM) and MIDcounter configuration on APP

To complete installation, the final configuration of the **eLuxWallbox** and its accessories should be set via the dedicated app

PowerUp is a smartphone app for qualified installers only, available via Google Play™ and Apple Store®. The configuration is carried out via a Bluetooth connection. The wallbox cannot operate correctly if not configured via the app.



NOTICE: Make sure you have the latest version of PowerUp to have access to all of the features.

Follow the instructions below to get started with the app:

Download PowerUp to your smartphone and activate Bluetooth on the smartphone.



Scan **eLuxWallbox** QR code to pair it with the app. The QR Code can be found on the side of the charger.

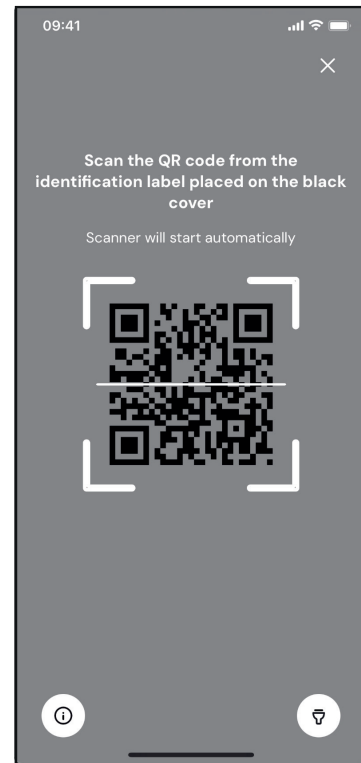

Once paired, complete the configuration set up of **eLuxWallbox** and its Accessories by clicking on the parameter to be configured.

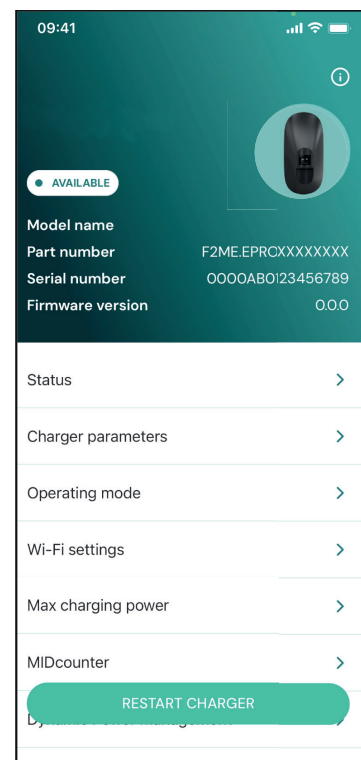

4.5. PowerMeter (DPM) configuration

To complete installation of the **PowerMeter (DPM)**, follow the steps below:

Select "**DPM PowerMeter**" on the homepage

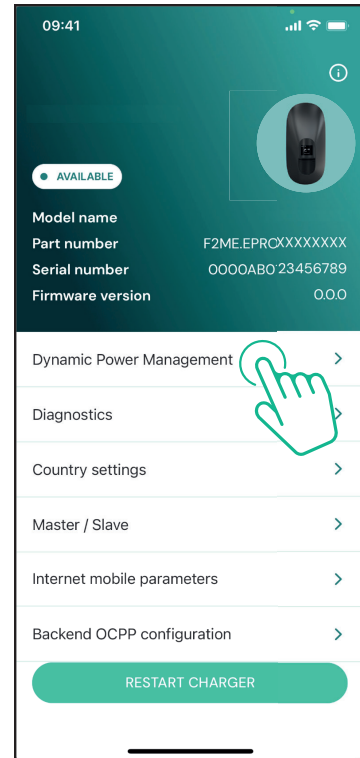

Select the **PowerMeter** type from the drop-down menu, matching the model installed.

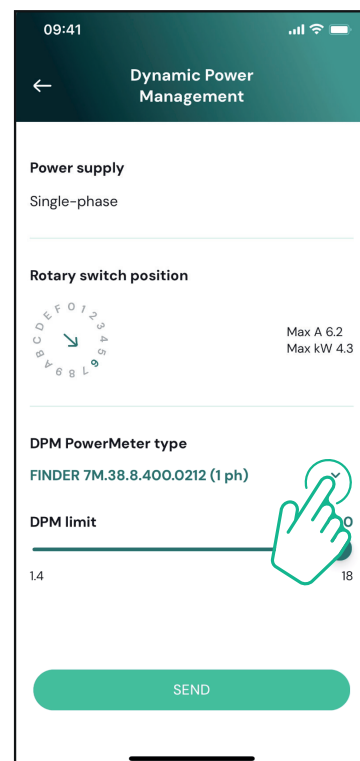

Enter the value of the user contractual power as **DPM** power limit.

For Indirect Meter only - Set the CT current ratio with the slider.

- With CTV 60 A set 60 as Current ratio
- With CTA 100 A set 20 as Current ratio
- With CTA 150 A set 30 as Current ratio

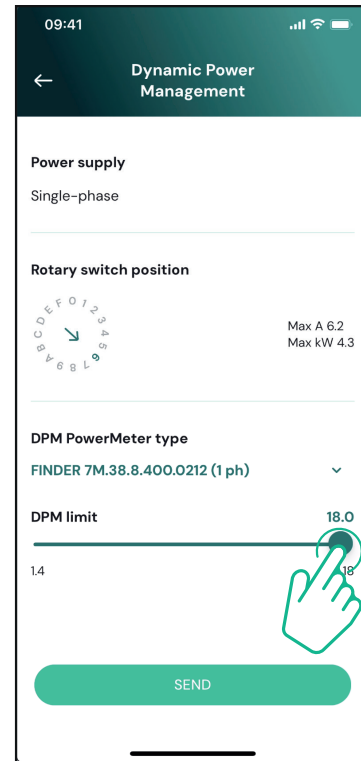

Click "Send" and confirm on the pop-up to restart **eLuxWallbox**.

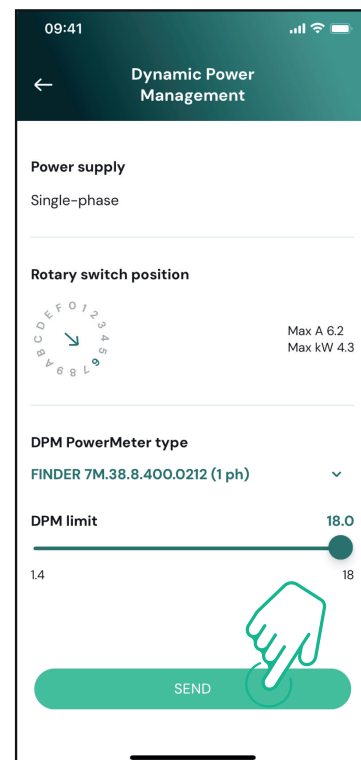

4.6. MIDcounter configuration

To complete installation of the **MIDcounter**, follow the steps below:

Select "**MIDcounter**" on the homepage

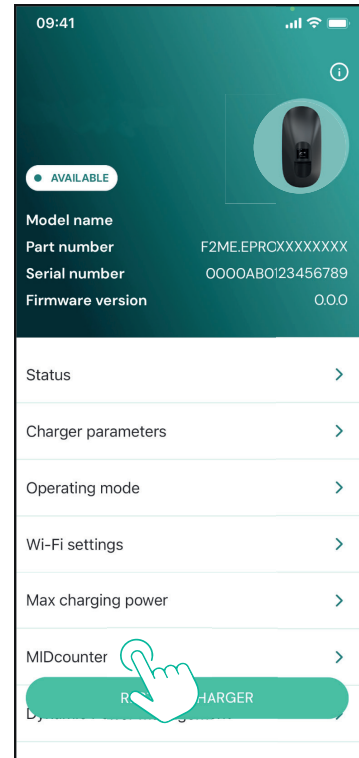

Select the **MIDcounter** type from the drop down menu, based on the model installed.

Select "OFF" from the drop down menu to disable the **MIDcounter** configuration.

Click "Send" to confirm.

To make the changes effective, click on the back arrow in the top left corner and restart **eLuxWallbox** through the dedicated button in the homepage.

If the installation has both the **PowerMeter (DPM)** and the **MIDcounter** it is possible to proceed with **DPM** configuration before restarting.

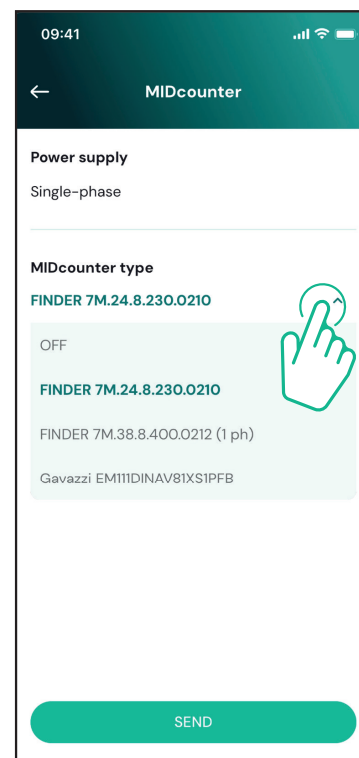

5. TROUBLESHOOTING

Error conditions are stored in the diagnostic logs and shown on the charger panel:

- On the **eLuxWallbox Move** model, the LED bar blinks red. See the **Diagnostic** section of PowerUP or the end-user App for the detailed error code.
- On the **eLuxWallbox** model, the display shows the error code, which is also available in the **Diagnostic** section of PowerUP.

When an error occurs, the charge is interrupted, and the socket is unlocked to allow you to disconnect the plug.

The following table provides a list of errors that can occur and the relative troubleshooting. If the error persists, note the serial number on the charger label and contact Customer Service.

Error code / issue	"Error Description"	Troubleshooting
100	Lack of power supply	<p>Check if the circuit breaker is ON. Check that the CN1 cabling is correct. Check the voltage in CN1.</p>
101	Overheating	<p>Disconnect the Type 2 cable, wait for the temperature to drop, then the error will clear.</p> <p>To restart the charging session, plug in the cable again. Make sure that installation site is compatible with temperature range (25°C/+50°C without direct exposure to sunlight)</p>
102	Communication error between MCU and MPU.	<p>Restart the charger from the circuit breaker, leaving the charger switched off for at least 60 seconds.</p>
103	Hardware fault, ground protection device error (GPD error)	<p>Check the cabling on CN1:</p> <ul style="list-style-type: none"> - in single-phase, make sure that ground cable is connected to PE, the Neutral cable is connected to N and the phase cable to T - in three-phase, make sure that the ground cable is connected to PE, the Neutral cable is connected to N and the phase cables L1, L2 and L3 are connected to T, S, and R. <p>Check whether the voltage difference between PE and N does not exceed 10V. Check PE connection</p> <p>If all connections are checked and the error persists, open the charger and modify the configuration of the Dipswitch (SW2) connector.</p>

104	Hardware fault, residual current monitor AC error. (RCM AC trip)	<p>Try to start a new charging session, removing and plugging in all the connectors.</p> <p>If the problem persists, check for the presence of any problems in the charging cable or vehicle inlet.</p> <p>If the cables and the EV don't show any problem, check CN27 connector and RCM cable.</p>
105	Hardware fault, residual current monitor DC error. (RCM DC trip)	<p>Check that the problem is not with the cable or vehicle. If possible, try another charging session with a different cable or vehicle.</p>
106	Internal meter error	<p>Restart the charger from the circuit breaker, leaving the charger switched off for at least 60 seconds.</p>
107	PowerMeter (DPM) communication error	<p>Check that the communication configuration on the DPM PowerMeter device is correct.</p> <p>Check that the DPM model configuration in the installer App is correct.</p> <p>Check the communication cable wiring on CN12.</p> <p>Check that the communication cable used is suitable for Modbus RS485 and cable length.</p>
108	Configuration Error, Rotary switch position (supply type) is not consistent with the DPM/ MID type.	<p>Check the position of the rotary switch. If it is not consistent with the 1-ph/3-ph installation, change it according to the table in the manual, then restart the charger.</p> <p>If the accessories (DPM/MID) are not installed, make sure that the function is disabled in the installer App.</p> <p>If the accessories (DPM/MID) are installed, check that the correct model is selected on the installer App. Then restart the charger.</p>
109	Main/secondary RS485 communication error	<p>Check the configuration of the Main/Secondary set up from installer App.</p> <p>Check that the Main charger is available.</p> <p>Check that the wiring of the communication cable on CN9 and CN10 is correct.</p> <p>Check that the communication cable used is suitable for Modbus RS485.</p>

110	MIDcounter communication error	<p>Check that the communication configuration on the MIDcounter device is correct.</p> <p>Check the communication cable wiring on CN12.</p> <p>Check that the communication cable used is suitable for Modbus RS485.</p> <p>Check that the MID model configuration in the installer App is correct.</p>
300	Inconsistency between the charger contactor command and feedback	<p>Restart the charger from the circuit breaker, leaving the charger switched off for at least 60 seconds.</p> <p>If error persists even after restart, call Customer Service.</p>
301	Short circuit detected on the Control Pilot line.	<p>With the charger switched off, check that there is no damage and no defects inside and outside the socket (if so, avoid using the charger and contact Customer Service).</p> <p>Check that the problem is not related to the cable or vehicle and try another charge session (with another vehicle or cable if possible).</p>
302	State E or F set on the Control Pilot line.	<p>With the charger switched off, check that there is no damage and no defects inside and outside the cable and its connectors (if so, avoid using it and attempt charge with another cable).</p>
303	Control Pilot disconnected.	<p>Check that the cable connectors are fully inserted inside the charger socket and vehicle inlet.</p>
304	Proximity Pilot disconnected.	<p>Check that the problem is not related to the cable or vehicle and try another charge session (with another vehicle or cable if possible).</p>
305	Broken Proximity Pilot detected.	<p>Check that the problem is not related to the cable or vehicle and try another charge session (with another vehicle or cable if possible).</p>
306	Diode fault detected on Control Pilot line (no - 12V).	<p>Attempt a new charging session unplugging and reinserting the cable from both the charger and vehicle inlet.</p>
307	Control Pilot disconnected.	<p>With the charger switched off, check that there is no damage and no defects inside and outside the cable and its connectors (if so, avoid using it and attempt charge with another cable).</p> <p>Check that the cable connectors are fully inserted inside the charger socket and vehicle inlet.</p> <p>Check that the problem is not related to the cable or vehicle and try another charge session (with another vehicle or cable if possible).</p>

308	Inconsistency between the motor command and feedback, or the motor is in an error condition.	<p>Attempt a new charging session unplugging and reinserting the cable from both the charger and vehicle inlet.</p> <p>Check that the cable connectors are fully inserted inside the charger socket and vehicle inlet.</p>
309	Motor check error during EVSE initialization phase.	Restart the charger from the circuit breaker, leaving the charger switched off for at least 60 seconds.
310	Error detected before charging (PP not detected, or motor fault, or CP not detected).	<p>With the charger switched off, check that there is no damage and no defects inside and outside the cable and its connectors (if so, avoid using it and attempt charge with another cable).</p> <p>Check that the cable connectors are fully inserted inside the charger socket and vehicle inlet.</p>
311	Error detected after charging (motor fault, or CP not disconnected).	Check that the problem is not related to the cable or vehicle and try another charge session (with another vehicle or cable if possible).
312	Emergency stop received from the MPU.	Restart the charger from the circuit breaker, leaving the charger switched off for at least 60 seconds.
313	Current detected during charging, with 100% duty cycle on the Control Pilot line.	Check that the problem is not cable nor vehicle related, attempt a new charging session with another cable and/or charger.
315	Current over limits on phase L1	Unplug the cable, if possible lower the power of charge on the vehicle side and attempt a new charging session.
316	Current over limits on phase L2	
317	Current over limits on phase L3	
318	Voltage below a threshold on phase L1	<p>Check the rotary switch position is consistent with 1-ph/3-ph installation.</p> <p>Check that the voltage on CN1-T is above 196 V.</p> <p>If the voltage is below 196 V, check the electric system or contact the energy supplier.</p> <p>If an error occurs during vehicle charging, try to reduce the set-up charging power and verify that the electric system is correctly dimensioned for the power drawn by the vehicle.</p>

319	Voltage below a threshold on phase L2	The rotary switch is in a three-phase position. Check that the intended installation is in three-phase. If not, select the correct rotary switch position as per Installation Manual.
320	Voltage below a threshold on phase L3	<p>Check that the voltage on CN1-S and R is above 196 V. If the voltage is below 196V, check the electric system or contact the energy supplier.</p> <p>If an error occurs during vehicle charging, try to reduce the set-up charging power and verify that the electric system is correctly dimensioned for the power drawn by the vehicle.</p>
321	Forbidden state change (IEC 61851-1)	<p>EV does not meet IEC 61851-1 standards for starting a charge session.</p> <p>Attempt a new charging session unplugging and reinserting the cable from both the charger and vehicle inlet.</p> <p>If the error persists, contact the vehicle manufacturer.</p>
	Display/LED stuck in Welcome mode (LED blinks red-green-blue)	Restart the charger from the circuit breaker, leaving the charger switched off for at least 60 seconds.
	LED or display does not light up at startup	
	The charger does not start	<p>Let the unit restart, it may take up to 30 seconds.</p> <p>Check if the circuit breaker is ON.</p> <p>Check that the CN1 cabling is correct.</p> <p>Check the voltage in CN1.</p> <p>Restart the charger from the circuit breaker, leaving the charger switched off for at least 60 seconds.</p>
	Cable stuck in the charger socket	Turn off the charger from the circuit breaker, then remove the cable.
	Suspended Charging with solid green LED/ message on the display. The charging session is suspended by the DPM or the EV. The session may resume.	<p>Verify that the max power in the DPM power limit section of the installer App is consistent with the contract power value in kW as indicated in the user's electricity contract. If the value is correct, wait for the charging session to resume or turn off some house loads.</p> <p>In the case of 3-ph installation, verify that the electrical loads are well balanced on the phases of the domestic system.</p>

	<p>App pairing does not complete after QR scan.</p>	<p>Check the integrity of the QR code on the label. Update the App to the latest version. Close and restart the App, then try again. Restart the charger from the circuit breaker, leaving the charger switched off for at least 60 seconds.</p>
--	---	---

6. CLEANING

Cleaning the outside of the device is always recommended when necessary and should be carried out using a soft damp cloth with a mild detergent. When finished, wipe off any traces of moisture or liquid with a soft dry cloth.



CAUTION: Avoid strong jets of air or water as well as the use of soaps or detergents that are too harsh and corrosive for the materials of the charger.

7. PACKAGING DISPOSAL



Dispose of packaging in an environmentally friendly manner. The materials used for packaging this product can be recycled and must be disposed of in compliance with the legislation in force in the country of use. The following disposal directions will be found on the packaging based on the type of material.



NOTE: Further information about current disposal facilities can be obtained from local authorities.

8. ASSISTANCE

If you have any questions about the installation of **eLuxWallbox**. For any other information or requests for support, please contact Free2move eSolutions S.p.A. through the relevant section of its website: www.esolutions.free2move.com.

9. DISCLAIMER

Free2move eSolutions S.p.A. will not be held responsible for any damage directly or indirectly caused to people, things or animals due to the failure to comply with all the provisions set out in this Manual, and the warnings regarding the installation and maintenance of **eLuxWallbox**.

Free2move eSolutions S.p.A. reserves all rights to this document, the article and the illustrations it contains. The reproduction, whole or in part, disclosure to third parties or use of its contents is prohibited without the prior written consent of Free2move eSolutions S.p.A.

Any information in this manual may be changed without prior notice and does not represent any obligation on the part of the manufacturer. Images in this manual are for illustrative purposes only and might differ from the delivered product.

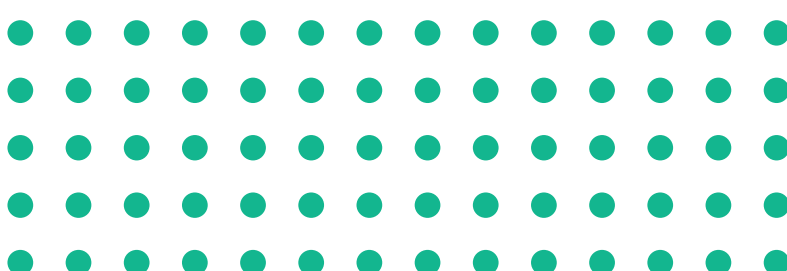

Registered office
Free2move eSolutions S.p.A.
Piazzale Lodi, 3
20137 Milan - Italy
www.esolutions.free2move.com